



# Intel<sup>®</sup> 860 Chipset Thermal Considerations

Application Note (AP-721)

---

*May 2001*



Information in this document is provided in connection with Intel® products. No license, express or implied, by estoppel or otherwise, to any intellectual property rights is granted by this document. Except as provided in Intel's Terms and Conditions of Sale for such products, Intel assumes no liability whatsoever, and Intel disclaims any express or implied warranty, relating to sale and/or use of Intel products including liability or warranties relating to fitness for a particular purpose, merchantability, or infringement of any patent, copyright or other intellectual property right. Intel products are not intended for use in medical, life saving, or life sustaining applications.

Intel may make changes to specifications and product descriptions at any time, without notice.

Designers must not rely on the absence or characteristics of any features or instructions marked "reserved" or "undefined." Intel reserves these for future definition and shall have no responsibility whatsoever for conflicts or incompatibilities arising from future changes to them.

The Intel® 860 chipset may contain design defects or errors known as errata which may cause the product to deviate from published specifications. Current characterized errata are available on request.

Contact your local Intel sales office or your distributor to obtain the latest specifications and before placing your product order.

I<sup>2</sup>C is a two-wire communications bus/protocol developed by Philips. SMBus is a subset of the I<sup>2</sup>C bus/protocol and was developed by Intel. Implementations of the I<sup>2</sup>C bus/protocol may require licenses from various entities, including Philips Electronics N.V. and North American Philips Corporation.

Copies of documents which have an ordering number and are referenced in this document, or other Intel literature, may be obtained by calling 1-800-548-4725 or by visiting Intel's website at <http://www.intel.com>.

Intel and Intel Xeon are trademarks or registered trademarks of Intel Corporation or its subsidiaries in the United States and other countries.

\*Other names and brands may be claimed as the property of others.

Copyright® 2001, Intel Corporation



# Contents

---

1	Introduction .....	7
1.1	Definition of Terms.....	7
1.2	Reference Documents and Information Sources.....	7
1.3	Design Flow .....	8
1.4	Thermal Simulation.....	8
2	Thermal Reference.....	9
2.1	Power .....	9
2.2	Die Temperature.....	9
2.3	Operating Environmental Specifications.....	10
3	Mechanical Reference.....	11
3.1	Package Dimensions .....	11
3.2	Thermal Enhancements (Generic Solutions).....	11
3.2.1	Heatsink Orientation.....	12
3.2.2	Volume Keepouts .....	13
3.2.3	Extruded Heatsink Profiles .....	14
3.2.4	Mechanical Interface Material .....	14
3.2.5	Thermal Interface Material .....	15
3.2.6	Heatsink Clip .....	15
3.2.7	Clip Retention Anchors.....	15
3.2.8	Board Keepout Patterns .....	15
3.3	Reliability.....	16
4	Measurements for Thermal Specifications.....	17
4.1	Die Temperature Measurements .....	17
4.2	Power Simulation Software.....	18
5	Conclusion.....	19
	APPENDIX A: Heatsink, Attach, and BOM Suppliers .....	21

## Figures

Figure 1. Thermal Design Process .....	8
Figure 2. Generic Thermal Solution Assembly .....	11
Figure 3. Proper Heatsink Orientation .....	12
Figure 4. Heatsink Volume Restrictions for the 82860 MCH.....	13
Figure 5. Extruded Heatsink Profiles for the 82860 MCH.....	14
Figure 6. Intel® 860 Chipset Mechanical Interface.....	14
Figure 7. 82860 MCH Anchor Layout .....	15
Figure 8. Intel® 860 Chipset Keepout Zones .....	16
Figure 9. Technique for Measuring T <sub>die</sub> with 90° Angle Attachment.....	18
Figure 10. Thermal Enhancement Decision Flowchart .....	18

## Tables

Table 1. 82860 MCH Thermal Absolute Maximum Rating .....	9
Table 2. MRH-R Thermal Absolute Maximum Rating .....	9
Table 3. ICH2 Thermal Absolute Maximum Rating .....	9
Table 4. P64H Thermal Absolute Maximum Rating .....	9
Table 5. Reliability Validation.....	16
Table 6. Specification Summary.....	19
Table 7. Extruded Heatsinks .....	21
Table 8. Interface Materials .....	21
Table 9. Attach Hardware .....	21



## Revision History

---

Revision Number	Description	Revision Date
-001	Initial Release.	May 2001

This page is intentionally left blank.

# 1 Introduction

The objective of thermal management is to ensure that the temperature of all components in a system is maintained within functional limits. The functional temperature limit is the range within which the electrical circuits can be expected to meet specified performance requirements. Operation outside the functional limit can degrade system performance, cause logic errors, or cause component and/or system damage. Temperatures exceeding the maximum operating limits may result in irreversible changes in the operating characteristics of the component. The goal of this document is to provide an understanding of the operating limits of the Intel® 860 chipset and discuss a generic thermal solution.

## 1.1 Definition of Terms

Term	Description
OLGA	Organic Land Grid Array. A package type defined by a resin-fiber substrate; a die is mounted using an underfill C4 (Controlled Collapse Chip Connection) attach style. The primary electrical interface is an array of solder balls attached to the substrate opposite the die. Note that the device arrives at the customer with solder balls attached.
Lands	The pads on the PCB where the BGA balls are soldered.
TDP	Thermal Design Power. This is the target power that the thermal solution should dissipate.

## 1.2 Reference Documents and Information Sources

Document	Document Number / Location
Intel® 82801BA I/O Controller Hub (ICH2) and Intel® 82801BAM I/O Controller Hub (ICH2-M) Datasheet	290687
Intel® 860 Chipset: 82860 Memory Controller Hub (MCH) Datasheet	290713
Intel® Xeon™ Processor and Intel® 860 Chipset Platform Design Guide	298252
Integrated Circuit Thermal Measurement Method-Electrical Test Method	EIA/JESD51-1
Integrated Circuits Thermal Test Method Environmental Conditions – Natural Convection (Still Air)	EIAJESD51-2
Platform Development Support Web Site: Support for development of ATX, FlexATX, microATX, and NLX form factor specifications <a href="http://www.teleport.com/~ffsupport/">http://www.teleport.com/~ffsupport/</a>	
WTX Specification	<a href="http://www.wtx.org">http://www.wtx.org</a>
Intel® 850 Chipset and Intel® 860 Chipset Thermal User's Guide	
Intel® 850 Chipset and Intel® 860 Chipset Power Utility User's Guide	
BGA/OLGA Development Guide Rev 1.1	

## 1.3 Design Flow

To develop a reliable, cost-effective thermal solution, several tools are available to the system designer. Figure 1 illustrates the design process implicit to this document and the tools appropriate for each step.

**Figure 1. Thermal Design Process**

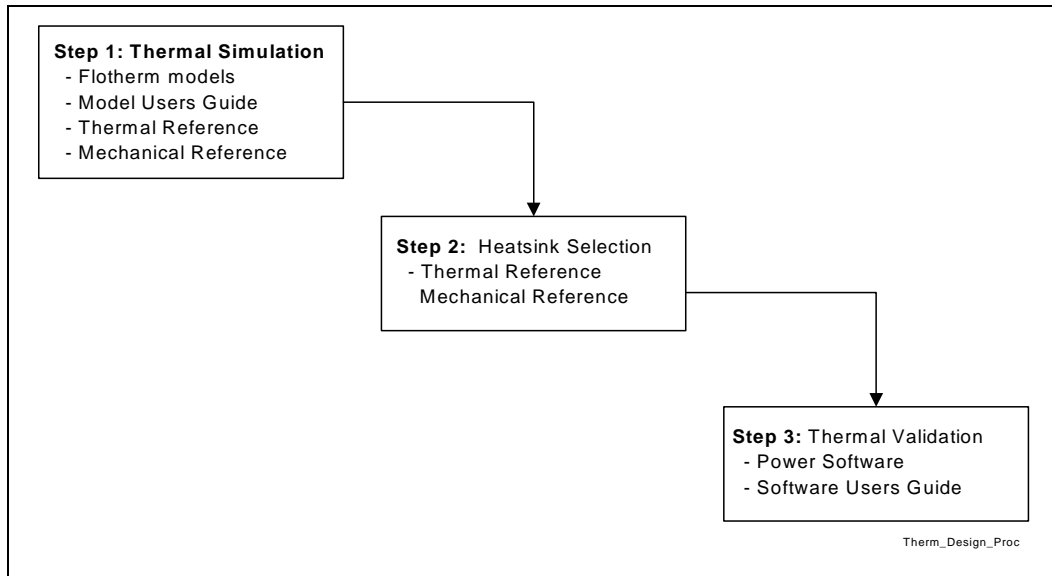

## 1.4 Thermal Simulation

Simulation models of the Intel 860 chipset and an associated user guide are provided to aid system designers in simulating, analyzing, and optimizing their thermal solutions in an integrated system-level environment. The models have been created for use with the commercially available Computational Fluid Dynamics (CFD)-based thermal analysis tool “FLOTHERM<sup>®</sup>” (version 2.1 or higher) by Flomerics Inc. Section 1.2 lists the source of the models and user guide.



## 2 Thermal Reference

---

### 2.1 Power

The Thermal Design Power (TDP) for each component can be found in the respective component datasheet. Refer to the appropriate section to verify the respective thermal specifications for the Intel 860 chipset. OLGA packages without thermal enhancement poorly utilize heat transfer into the board and have minimal thermal capability. It is recommended to plan for a heatsink when using the Intel 860 chipset.

### 2.2 Die Temperature

To ensure proper operation and reliability of the Intel 860 chipset, the die temperature must be at or below the values specified for each component in Table 1 to Table 4. If the die temperature exceeds the maximum temperatures listed, system or component level thermal enhancements will be required to dissipate the heat generated.

**Table 1. Intel® 82860 MCH Thermal Absolute Maximum Rating**

Parameter	Maximum
$T_{\text{die-nhs}}$ (Note 1)	105 °C
$T_{\text{die-hs}}$ (Note 2)	84 °C

**Table 2. MRH-R Thermal Absolute Maximum Rating**

Parameter	Maximum
$T_{\text{case-nhs}}$ (Note 3)	110 °C
$T_{\text{case-hs}}$ (Note 2)	97 °C

**Table 3. ICH2 Thermal Absolute Maximum Rating**

Parameter	Maximum
$T_{\text{case-nhs}}$ (Note 3)	109 °C

**Table 4. P64H Thermal Absolute Maximum Rating**

Parameter	Maximum
$T_{\text{case-nhs}}$ (Note 3)	110 °C

**NOTES:** For Table 1 to Table 4

- $T_{\text{die-nhs}}$  is defined as the maximum die temperature without any thermal enhancement to the package.
- $T_{\text{die-hs}}$  and  $T_{\text{case-hs}}$  are defined as the maximum die temperature with the generic thermal solution attached (see Section 2.3).
- $T_{\text{case-nhs}}$  is defined as the maximum package case temperature without any thermal enhancement to the package.



## 2.3 Operating Environmental Specifications

To ensure proper operation and reliability of the Intel® 860 chipset generic thermal solution, the maximum allowable operating temperature is 50 °C. The minimum recommended airflow over the package is 100 LFM (linear feet per minute). The thermal designer must carefully select the location to measure airflow to get a representative sampling.

**Note:** These environmental specifications are based on a 35 °C, 5000' system ambient temperature and altitude conditions.

## 3 Mechanical Reference

### 3.1 Package Dimensions

The Intel® 82860 MCH is packaged in a 42.5 mm, 6-layer OLGA. The P64H is packaged in a 23 mm, 4-layer  $\mu$ BGA\* Chip-Scale Package (CSP). The ICH2 is packaged in a 23 mm, 4-layer  $\mu$ BGA. CSP Refer to the respective component datasheet for package dimensions.

### 3.2 Thermal Enhancements (Generic Solutions)

Intel has developed Generic Thermal Solutions for the Intel 82860 MCH. These do not preclude the design of user specific solutions that may be based on these designs.

The generic solution is a passive extruded heatsink with thermal and mechanical interfaces. It is attached using a clip with each end hooked through an anchor soldered to the board. Figure 2 shows views of the generic solution.

Sources for each component of the thermal solution are provided in Appendix A.

**Figure 2. Generic Thermal Solution Assembly**

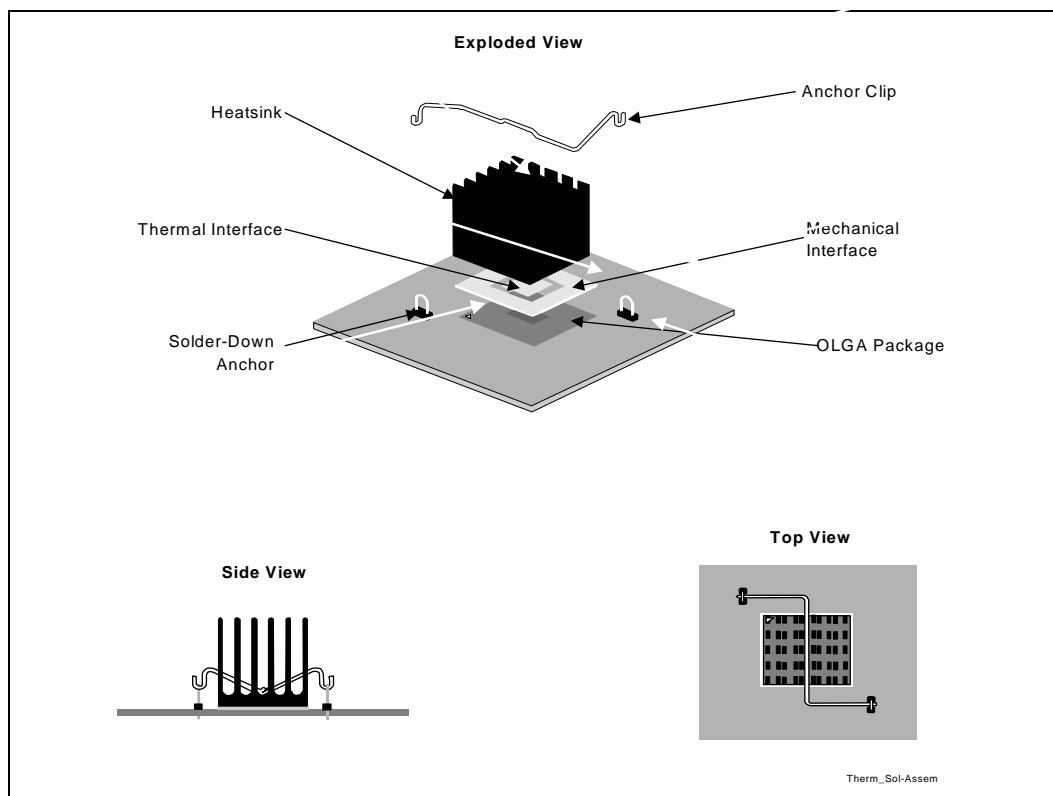

### 3.2.1 Heatsink Orientation

To enhance the efficiency of the Generic Thermal Solution Assembly, it is important for the designer to orient the fins properly with respect to the mean airflow direction. Simulation and experimental evidence have shown that the Intel 860 chipset Pin Fin Heatsink's thermal performance is enhanced when the fins are aligned with the mean air flow direction (see Figure 3).

Figure 3. Proper Heatsink Orientation

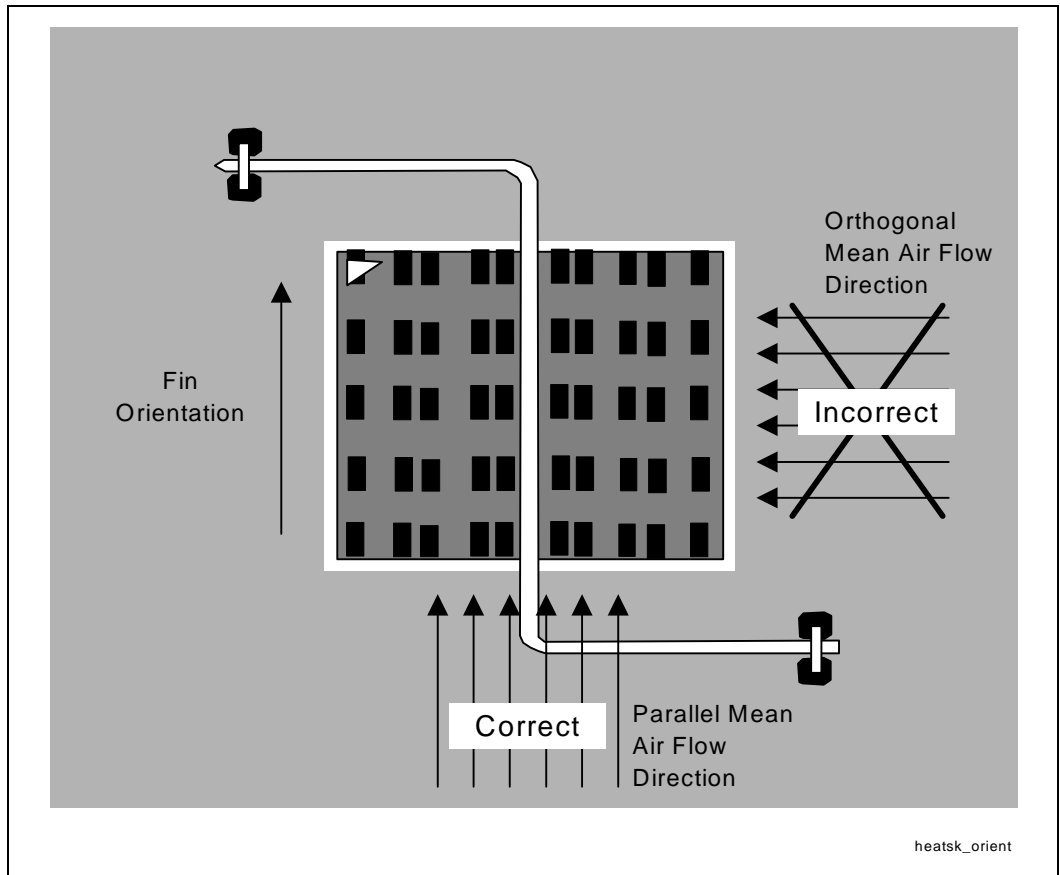

### 3.2.2 Volume Keepouts

Though each design may have unique mechanical volume and height restrictions or implementation requirements, the height, width, and depth constraints typically placed on the Intel 860 chipset components are shown in Figure 4.

When using heatsinks that extend beyond the component, the motherboard component height under the Intel 860 chipset components is limited to 0.090 inch.

**Figure 4. Heatsink Volume Restrictions for the Intel® 82860 MCH**

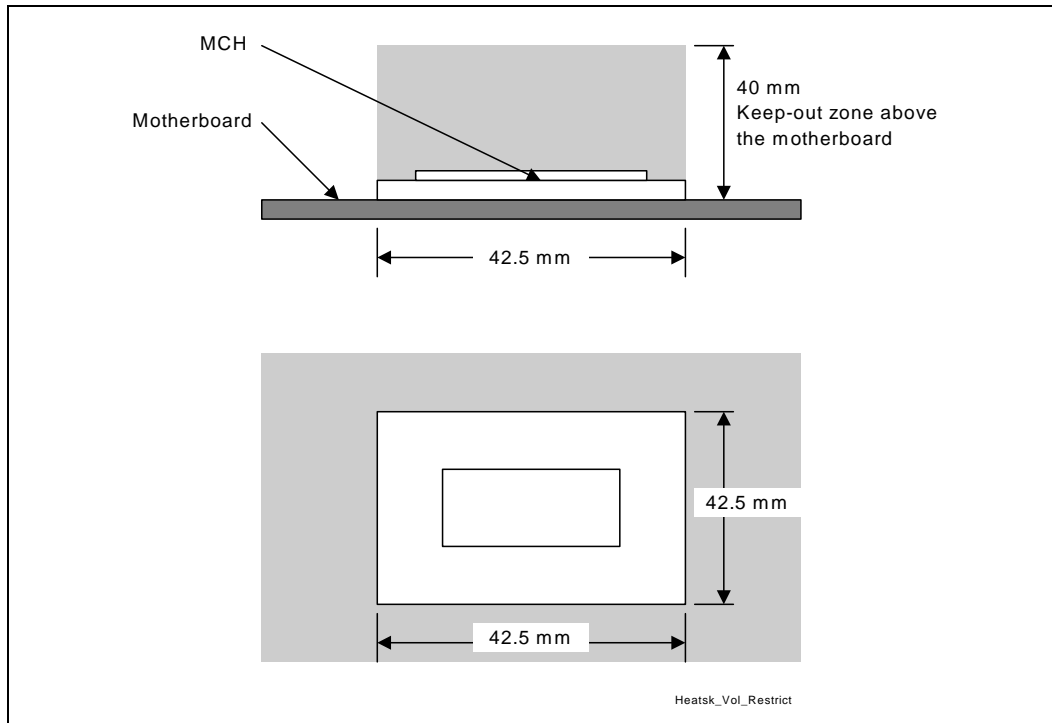

### 3.2.3 Extruded Heatsink Profiles

Extruded heatsinks are the generic thermal enhancements for the Intel 860 chipset (see Figure 5). Tolerance information is not given in this document. Check with your supplier for specific tolerances. Suppliers for the Extruded heatsinks are listed in Appendix A.

**Figure 5. Extruded Heatsink Profiles for the Intel® 82860 MCH**

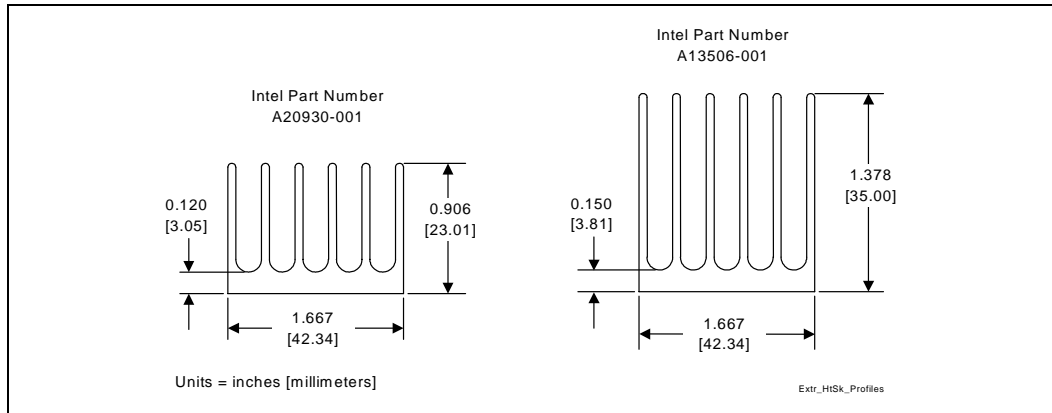

### 3.2.4 Mechanical Interface Material

To avoid cracking of the exposed die a mechanical interface is used. This interface reduces mechanical loads experienced by the die. The generic solutions use a picture frame gasket of 0.032inch thick Poron® foam. Figure 6 shows the respective dimensions of gaskets for Intel 860 chipset.

**Figure 6. Intel® 860 Chipset Mechanical Interface**

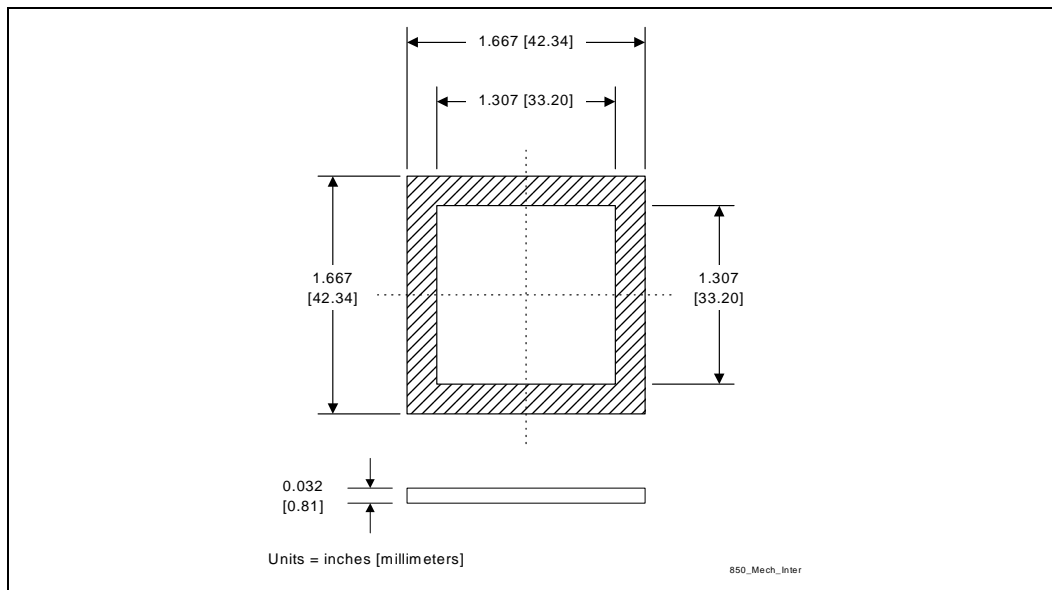

### 3.2.5 Thermal Interface Material

To provide good conductivity from the die to the heatsink a thermal interface material is used. The generic solutions use Chomerics\* T-710, 0.005 inch thick, 1.0 inch x 1.0 inch.

### 3.2.6 Heatsink Clip

The generic solution uses a wire clip with hooked ends. The hooks attach to wire anchors to fasten the clip to the board.

### 3.2.7 Clip Retention Anchors

For Intel 860 chipset-based platforms that have very limited board space, a clip retention anchor has been developed to minimize the impact of clip retention on the board. It has been modified from a standard three-pin jumper and is soldered to the board like any common through-hole header.

### 3.2.8 Board Keepout Patterns

The locations of hole patterns and keepout zones for the generic solutions are shown in Figure 7 and Figure 8.

Figure 7. Intel® 82860 MCH Anchor Layout

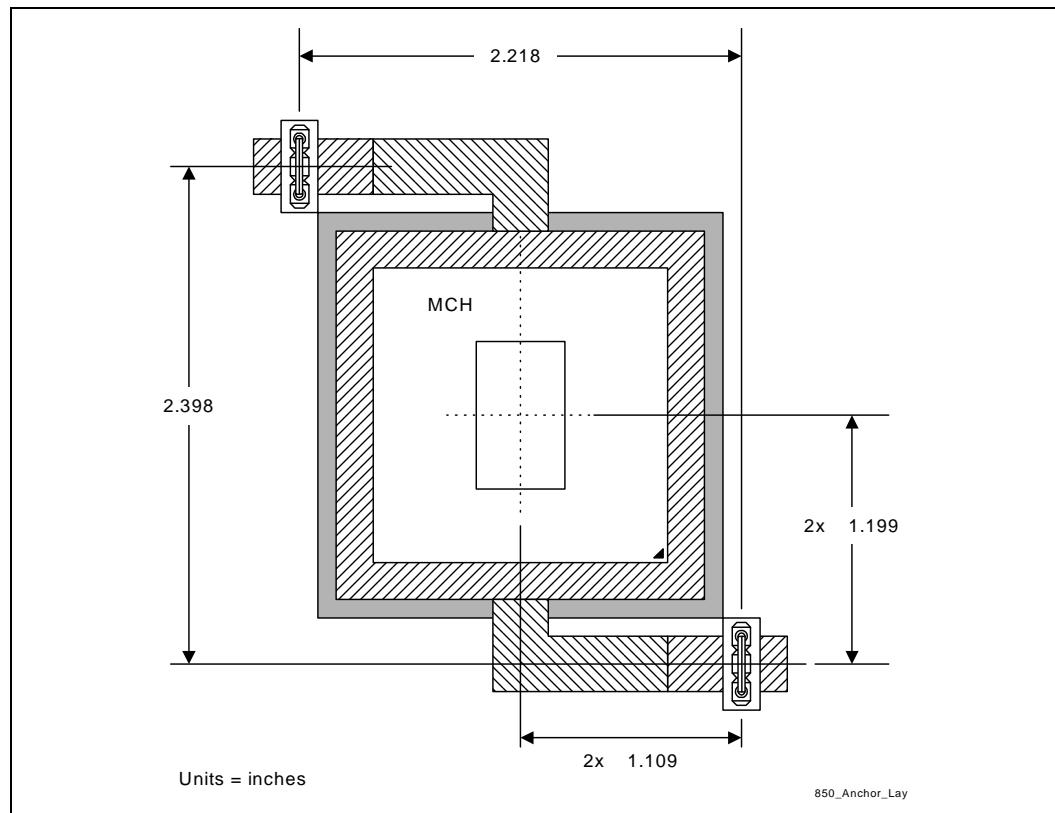
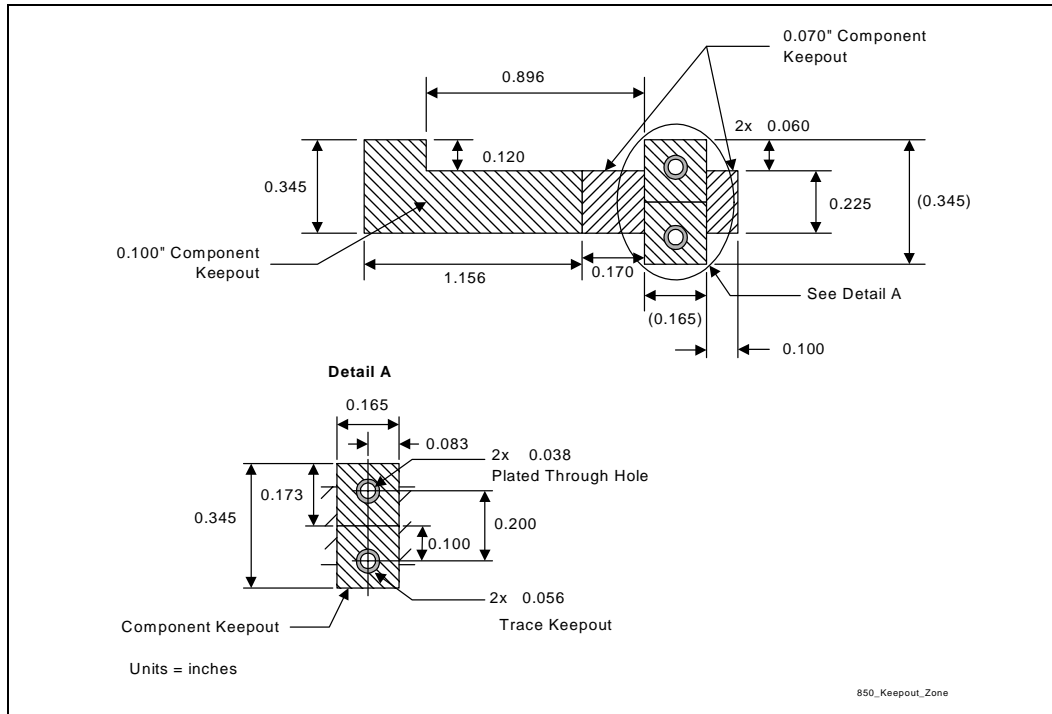

Figure 8. Intel® 860 Chipset Keepout Zones



### 3.3 Reliability

Each motherboard, heatsink, and attach combination may vary the mechanical loading of the component. It is recommended that the user carefully evaluate the reliability of the completed assembly prior to use in high volume. Some general recommendations are shown in the Table 5.

Table 5. Reliability Validation

Test <sup>1</sup>	Requirement	Pass/Fail Criteria <sup>2</sup>
Mechanical Shock	50 G, board level 11 ms, 3 shocks/direction	Visual\Electrical Check
Random Vibration	7.3 G, board level 45 minutes/axis, 50 to 2000 Hz	Visual\Electrical Check
Temperature Life	85 °C, 2000 hours total, checkpoints occur at 168, 500, 1000 and 2000 hours	Visual Check
Thermal Cycling	-5 °C to +70 °C 500 Cycles	Visual Check
Humidity	85% relative humidity 55 °C, 1000 hours	Visual Check

**NOTES:**

1. The above tests should be performed on a sample size of at least 12 assemblies from three lots of material.
2. Additional Pass/Fail Criteria may be added at the discretion of the user.



## 4 Measurements for Thermal Specifications

---

To appropriately determine the thermal properties of the system, measurements must be made. Guidelines have been established for the proper techniques to be used when measuring the Intel 860 chipset die temperatures. Section 4.1 provides guidelines on how to accurately measure the die temperature of the Intel 860 chipset. Section 4.2 contains information on running an application program that will emulate anticipated maximum thermal design power. The flowchart in Figure 10 offers useful guidelines for performance and evaluation.

### 4.1 Die Temperature Measurements

To ensure functionality and reliability, the Intel 860 chipset is specified for proper operation when  $T_{\text{die}}$  (die temperature) is maintained at or below their respective maximum die temperatures listed in Table 1 through Table 4. The surface temperature of the die in the geometric center of the die is measured. Special care is required when measuring the  $T_{\text{die}}$  temperature to ensure an accurate temperature measurement.

When measuring the temperature of a surface that is at a different temperature from the surrounding local ambient air, errors could be introduced in the measurements. The measurement errors could be due to a poor thermal contact between the thermocouple junction and the surface of the package, heat loss by radiation, convection, conduction through thermocouple leads, or contact between the thermocouple cement and the heatsink base for those solutions that implement a heatsink. To minimize these measurement errors, the following approach is recommended:

#### Attaching the Thermocouple

- Use 36 gauge or smaller diameter K-type thermocouples.
- Ensure that the thermocouple has been properly calibrated.
- Attach the thermocouple bead or junction to the top surface of the die in the center using a high thermal conductivity cement. **It is Critical that the entire thermocouple lead be butted tightly with the die.**
- The thermocouple should be attached at a 90° angle if there is no interference with the thermocouple attach location or leads (refer to Figure 9). This is the preferred method and is recommended for use with both unenhanced packages as well as packages employing Thermal Enhancements.
- The hole size through the heatsink base to route the thermocouple wires out should be smaller than 0.150 inch in diameter.
- Make sure there is no contact between the thermocouple cement and heatsink base. This contact will affect the thermocouple reading.

Figure 9. Technique for Measuring  $T_{die}$  with 90° Angle Attachment

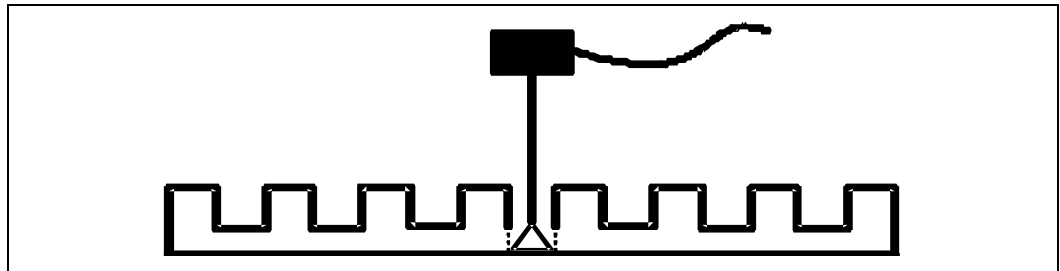

## 4.2 Power Simulation Software

The Power Simulation Software is a utility designed to test the thermal design power for an Intel 860 chipset when used in conjunction with an Intel® Xeon™ processor. The combination of the Intel Xeon processor and the higher bandwidth capability of the Intel 860 chipset enable new levels of system performance. To ensure the thermal performance of the Intel 860 chipset under “worst-case realistic application” conditions, Intel has developed a software utility that emulates this anticipated power dissipation.

The Power Utility has been developed solely for testing Thermal Design Power and customer thermal solutions (Figure 10). Real future applications may exceed the Thermal Design Power limit for transient time periods. For power supply current requirements under these transient conditions, refer to each component’s datasheet for the  $I_{CC}$  (Max Power Supply Current) specification. See Section 1.2 for information on how to obtain this software.

Figure 10. Thermal Enhancement Decision Flowchart

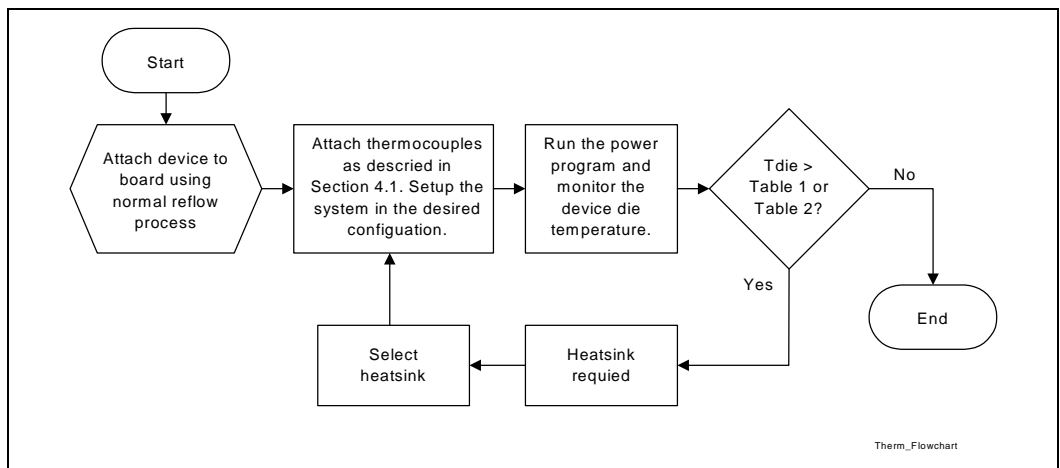

## 5 Conclusion

As the complexity of computer systems increases, so do the power dissipation requirements. Care must be taken to ensure that the additional power is properly dissipated. Heat can be dissipated using improved system cooling, selective use of ducting and/or passive heatsinks.

The simplest and most cost effective method is to improve the inherent system cooling characteristics through careful design and placement of fans, vents, and ducts. When additional cooling is required, thermal enhancements may be implemented in conjunction with enhanced system cooling. The size of the fan or heatsink can be varied to balance size and space constraints with acoustic noise.

This document has presented the conditions and requirements to properly design a cooling solution for systems implementing the Intel 860 chipset. Properly designed solutions provide adequate cooling to maintain the Intel 860 chipset die temperatures at or below those listed in Table 1 through Table 4. This is accomplished by providing a low local ambient temperature, adequate local airflow, and creating a minimal thermal resistance to heat transfer. By maintaining the respective Intel 860 chipset die temperature at or below those recommended in this document, a system will function without encountering thermal management issues.

**Table 6. Specification Summary**

<b>Package Dimensions</b>	
Intel® 82860 MCH	42.5 mm x 42.5 mm x 2.54 mm
<b>Handling Keepout on Substrate</b>	
Intel 82860 MCH	2 mm from edge of die
<b>Max Allowable Die Pressure</b>	
Intel 82860 MCH	410 kPa
<b>Volume Keepouts</b>	
Intel 82860 MCH	42.5 mm x 42.5 mm x 40 mm
<b>Operating Environment</b>	
Maximum Temperature	50 °C
Minimum Airflow	100 LFM
<b>Thermal Design Power (TDP)</b>	
Intel 82860 MCH	See Intel® 860 chipset datasheet
<b>Maximum Die/ Case Temperature without Heatsink</b>	
Intel 82860 MCH	105 °C
MRH-R	110 °C
P64H	110 °C
ICH2	109 °C
<b>Maximum Die Temperature with Heatsink</b>	
Intel 82860 MCH	84 °C



This page is intentionally left blank.

# APPENDIX A: Heatsink, Attach, and BOM Suppliers

**Table 7. Extruded Heatsinks**

Part	Intel Part Number	Suppliers
Intel® 860 chipset Pin Fin, 31 gm, 42 x 42 x 23 mm	A20930-001	Aavid Thermalloy
Intel 860 chipset Pin Fin, 43 gm, 42 x 42 x 35 mm	A13506-001	Aavid Thermalloy

**Table 8. Interface Materials**

Part	Intel Part Number	Supplier (Part Number)
Intel® 860 chipset thermal (T-710)	—	Chomerics (69-12-22315-T710)
Intel 860 chipset mechanical (Poron*)	A13502-002	Boyd (COL-800-002)

**Table 9. Attach Hardware**

Part	Intel Part Number	Suppliers
Intel® 860 chipset clip	A13504-001	Aavid Thermalloy
Solder-Down anchor	A13494-002	Foxconn Electronics

Some suppliers may be able to provide pre-assembled kits. Contact individual suppliers for information.

### Supplier Contact Information

Aavid Thermalloy, LLC	<a href="http://www.aavid.com">http://www.aavid.com</a>
Boyd Corporation	<a href="http://www.boydcorp.com">http://www.boydcorp.com</a>
Chomerics, Inc.	<a href="http://www.chomerics.com">http://www.chomerics.com</a>
Foxconn Electronics, Inc.	<a href="http://www.foxconn.com">http://www.foxconn.com</a>