

# Intel<sup>®</sup> Core<sup>™</sup> 2 Duo processor and Mobile Intel<sup>®</sup> GME965 Express Chipset

Development Kit User Manual

---

*June 2007*



INFORMATION IN THIS DOCUMENT IS PROVIDED IN CONNECTION WITH INTEL® PRODUCTS. NO LICENSE, EXPRESS OR IMPLIED, BY ESTOPPEL OR OTHERWISE, TO ANY INTELLECTUAL PROPERTY RIGHTS IS GRANTED BY THIS DOCUMENT. EXCEPT AS PROVIDED IN INTEL'S TERMS AND CONDITIONS OF SALE FOR SUCH PRODUCTS, INTEL ASSUMES NO LIABILITY WHATSOEVER, AND INTEL DISCLAIMS ANY EXPRESS OR IMPLIED WARRANTY, RELATING TO SALE AND/OR USE OF INTEL PRODUCTS INCLUDING LIABILITY OR WARRANTIES RELATING TO FITNESS FOR A PARTICULAR PURPOSE, MERCHANTABILITY, OR INFRINGEMENT OF ANY PATENT, COPYRIGHT OR OTHER INTELLECTUAL PROPERTY RIGHT. Intel products are not intended for use in medical, life saving, life sustaining, critical control or safety systems, or in nuclear facility applications.

Intel may make changes to specifications and product descriptions at any time, without notice.

Intel Corporation may have patents or pending patent applications, trademarks, copyrights, or other intellectual property rights that relate to the presented subject matter. The furnishing of documents and other materials and information does not provide any license, express or implied, by estoppel or otherwise, to any such patents, trademarks, copyrights, or other intellectual property rights.

Designers must not rely on the absence or characteristics of any features or instructions marked "reserved" or "undefined." Intel reserves these for future definition and shall have no responsibility whatsoever for conflicts or incompatibilities arising from future changes to them.

Intel processor numbers are not a measure of performance. Processor numbers differentiate features within each processor family, not across different processor families. See [http://www.intel.com/products/processor\\_number](http://www.intel.com/products/processor_number) for details.

The Intel® Core™ 2 Duo processor and Mobile Intel® GME965 Express Chipset may contain design defects or errors known as errata which may cause the product to deviate from published specifications. Current characterized errata are available on request.

Contact your local Intel sales office or your distributor to obtain the latest specifications and before placing your product order.

Copies of documents which have an order number and are referenced in this document, or other Intel literature may be obtained by calling 1-800-548-4725 or by visiting Intel's website at <http://www.intel.com>.

BunnyPeople, Celeron, Celeron Inside, Centrino, Centrino logo, Core Inside, Dialogic, FlashFile, i960, InstantIP, Intel, Intel logo, Intel386, Intel486, Intel740, IntelDX2, IntelDX4, IntelSX2, Intel Core, Intel Inside, Intel Inside logo, Intel. Leap ahead., Intel. Leap ahead. logo, Intel NetBurst, Intel NetMerge, Intel NetStructure, Intel SingleDriver, Intel SpeedStep, Intel StrataFlash, Intel Viiv, Intel vPro, Intel XScale, IPLink, Itanium, Itanium Inside, MCS, MMX, Oplus, OverDrive, PDCharm, Pentium, Pentium Inside, skool, Sound Mark, The Journey Inside, VTune, Xeon, and Xeon Inside are trademarks or registered trademarks of Intel Corporation or its subsidiaries in the United States and other countries.

\*Other names and brands may be claimed as the property of others.

Copyright © 2007, Intel Corporation. All Rights Reserved.

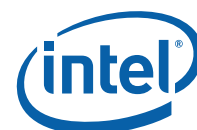

# Contents

---

1	About This Manual .....	6
1.1	Content Overview .....	6
1.2	Text Conventions .....	6
1.3	Glossary of Terms and Acronyms .....	8
1.4	Support Options .....	13
1.4.1	Electronic Support Systems .....	13
1.4.2	Additional Technical Support .....	13
1.5	Product Literature .....	13
1.6	Related Documents .....	14
2	Getting Started .....	15
2.1	Overview .....	15
2.1.1	Development Board Features .....	15
2.2	Included Hardware and Documentation .....	17
2.3	Software Key Features .....	17
2.3.1	AMI BIOS .....	18
2.4	Before You Begin .....	18
2.5	Setting Up the Development Board .....	20
2.6	Configuring the BIOS .....	22
3	Theory of Operation .....	24
3.1	Block Diagram .....	24
3.2	Mechanical Form Factor .....	24
3.3	Thermal Management .....	25
3.4	System Features and Operation .....	25
3.4.1	Mobile Intel® GME965 GMCH .....	25
3.4.2	ICH8-M .....	27
3.4.3	POST Code Debugger .....	31
3.5	Clock Generation .....	31
3.6	Power Management States .....	31
3.7	Power Measurement Support .....	33
4	Hardware Reference .....	39
4.1	Primary Features .....	39
4.2	Back Panel Connectors .....	41
4.2.1	TV-Out D-Connector .....	42
4.3	Configuration Settings .....	43
4.4	Power On and Reset Buttons .....	47
4.5	LEDs .....	48
4.6	Other Headers, Slots and Sockets .....	49
4.6.1	H8 Programming Headers .....	49
4.6.2	Expansion Slots and Sockets .....	50
Appendix A	Heatsink Installation Instructions .....	64



## Figures

Figure 1. Development Board Block Diagram.....	24
Figure 2. Development Board Component Locations .....	39
Figure 3. Back Panel Connector Locations .....	42
Figure 4. D-Connector to Component Video Cable.....	43
Figure 5. D-Connector to Composite Video Cable .....	43
Figure 6. D-Connector to S-Video Cable .....	43
Figure 7. Configuration Jumper and Switch Locations .....	44
Figure 8. LED Locations .....	48
Figure 9. Heatsink and Backplate .....	64
Figure 10. Backplate Pins .....	65
Figure 11. Applying the Thermal Grease .....	66
Figure 12. Squeezing Activation Arm.....	66
Figure 13. Installing the Heatsink.....	67
Figure 14. Plugging in the Fan .....	68
Figure 15. Completed Assembly .....	68

## Tables

Table 1. Text Conventions .....	7
Table 2. Terms and Acronyms.....	8
Table 3. Acronyms .....	10
Table 4. Intel Literature Centers.....	13
Table 5. Related Documents .....	14
Table 6. Development Board feature Set Summary .....	15
Table 7. BIOS Location Strapping Options.....	30
Table 8. Primary System Clocks .....	31
Table 9. Power Management States .....	32
Table 10. Power Management M-States .....	32
Table 11. Sleep Signals and M-State Definition.....	33
Table 12. Development Board Voltage Rails .....	34
Table 13. Development Board Component Location Legend .....	40
Table 14. Back Panel Connector Definitions.....	42
Table 15. Supported Configuration Jumper/Switch Settings.....	44
Table 16. LED Functions.....	48
Table 17. Expansion Slots and Sockets.....	50
Table 18. PCI Express* (x16) Pinout (J6B2) .....	51
Table 19. ADD2 Slot (J6B2) .....	54
Table 20. MEC Slot (J6B2).....	57
Table 21. PCI Express* (x1) Pinout (J6B1, J7B1, J8B4).....	60
Table 22. IDE Connector .....	60
Table 23. SATA Port 0 'Direct Connect' Connector Pinout (J8J1) .....	61
Table 24. SATA Ports 1 and 2 'Cable Connect' Connector Pinout (J7J3, J7H1).....	61
Table 25. SATA Power Connection (J7H2) .....	62
Table 26. Fan Connectors (J2B3, J2C1) .....	62
Table 27. Fan Connector (J2F1) .....	62
Table 28. Front Panel Connector.....	62
Table 29. USB Headers .....	63



## *Revision History*

---

<b>Document Number</b>	<b>Revision Number</b>	<b>Description</b>	<b>Revision Date</b>
316704	001	Initial public release.	June 2007

§



# 1 About This Manual

---

This user's manual describes the use of the Intel® Core™ 2 Duo processor and Mobile Intel® GME965 Express Chipset development kit. This manual has been written for OEMs, system evaluators, and embedded system developers. This document defines all jumpers, headers, LED functions, and their locations on the development board, along with subsystem features and POST codes. This manual assumes basic familiarity in the fundamental concepts involved with installing and configuring hardware for a personal computer system.

For the latest information about the Intel® Core™ 2 Duo processor and Mobile Intel® GME965 Express Chipset Development Kit, visit:

<http://developer.intel.com/design/intarch/devkits/index.htm>

For design documents related to this platform please visit:

Processor: [http://developer.intel.com/design/intarch/core2duo/tech\\_docs.htm](http://developer.intel.com/design/intarch/core2duo/tech_docs.htm)

Chipset: <http://www.intel.com/products/embedded/chipsets.htm>

## 1.1 Content Overview

Chapter 1.0, "About This Manual" — This chapter contains a description of conventions used in this manual. The last few sections explain how to obtain literature and contact customer support.

Chapter 2.0, "Getting Started"— Provides complete instructions on how to configure the development board and processor assembly by setting jumpers, connecting peripherals and providing power.

Chapter 3.0, "Theory of Operation" — This chapter provides information on the system design.

Chapter 4.0, "Hardware Reference"— This chapter provides a description of jumper settings and functions, development board debug capabilities, and pinout information for connectors.

Appendix A, "Heatsink Installation Instructions" gives detailed installation instructions for the Intel® Core™ 2 Duo processor heatsink.

## 1.2 Text Conventions

The notations listed in [Table 1](#) may be used throughout this manual.



Table 1. Text Conventions

Notation	Definition
#	The pound symbol (#) appended to a signal name indicates that the signal is active low. (e.g., PRSNT1#)
Variables	Variables are shown in italics. Variables must be replaced with correct values.
Instructions	Instruction mnemonics are shown in uppercase. When you are programming, instructions are not case-sensitive. You may use either uppercase or lowercase.
Numbers	Hexadecimal numbers are represented by a string of hexadecimal digits followed by the character H. A zero prefix is added to numbers that begin with A through F. (For example, FF is shown as 0FFH.) Decimal and binary numbers are represented by their customary notations. (That is, 255 is a decimal number and 1111 is a binary number. In some cases, the letter B is added for clarity.)
Units of Measure A GByte KByte KΩ mA MByte MHz ms mW ns pF W V μA μF μs μW	The following abbreviations are used to represent units of measure: amps, amperes gigabytes kilobytes kilo-ohms milliamperes, milliamperes megabytes megahertz milliseconds milliwatts nanoseconds picofarads watts volts microamps, microamperes microfarads microseconds microwatts
Signal Names	Signal names are shown in uppercase. When several signals share a common name, an individual signal is represented by the signal name followed by a number, while the group is represented by the signal name followed by a variable (n). For example, the lower chip-select signals are named CS0#, CS1#, CS2#, and so on; they are collectively called CSn#. A pound symbol (#) appended to a signal name identifies an active-low signal. Port pins are represented by the port abbreviation, a period, and the pin number (e.g., P1.0).



## 1.3 Glossary of Terms and Acronyms

[Table 2](#) defines conventions and terminology used throughout this document.

**Table 2. Terms and Acronyms**

Term/Acronym	Definition
Aggressor	A network that transmits a coupled signal to another network.
Anti-etch	Any plane-split, void or cutout in a VCC or GND plane.
Assisted Gunning Transceiver Logic+	The front-side bus uses a bus technology called AGTL+, or Assisted Gunning Transceiver Logic. AGTL+ buffers are open-drain, and require pull-up resistors to provide the high logic level and termination. AGTL+ output buffers differ from GTL+ buffers with the addition of an active pMOS pull-up transistor to assist the pull-up resistors during the first clock of a low-to-high voltage transition.
Asynchronous GTL+	The processor does not utilize CMOS voltage levels on any signals that connect to the processor. As a result, legacy input signals such as A20M#, IGNNE#, INIT#, LINT0/INTR, LINT1/NMI, PWRGOOD, SMI#, SLP#, and STPCLK# utilize GTL+ input buffers. Legacy output signals (FERR# and IERR#) and non-AGTL+ signals (THERMTRIP# and PROCHOT#) also utilize GTL+ output buffers. All of these signals follow the same DC requirements as AGTL+ signals, however the outputs are not actively driven high (during a logical 0 to 1 transition) by the processor (the major difference between GTL+ and AGTL+). These signals do not have setup or hold time specifications in relation to BCLK[1:0], and are therefore referred to as "Asynchronous GTL+ Signals". However, all of the Asynchronous GTL+ signals are required to be asserted for at least two BCLKs in order for the processor to recognize them.
Bus Agent	A component or group of components that, when combined, represent a single load on the AGTL+ bus.
Crosstalk	<p>The reception on a victim network of a signal imposed by aggressor network(s) through inductive and capacitive coupling between the networks.</p> <p>Backward Crosstalk - Coupling that creates a signal in a victim network that travels in the opposite direction as the aggressor's signal.</p> <p>Forward Crosstalk - Coupling that creates a signal in a victim network that travels in the same direction as the aggressor's signal.</p> <p>Even Mode Crosstalk - Coupling from a signal or multiple aggressors when all the aggressors switch in the same direction that the victim is switching.</p> <p>Odd Mode Crosstalk - Coupling from a signal or multiple aggressors when all the aggressors switch in the opposite direction that the victim is switching.</p>
Flight Time	<p>Flight time is a term in the timing equation that includes the signal propagation delay, any effects the system has on the <math>T_{CO}</math> (time from clock-in to data-out) of the driver, plus any adjustments to the signal at the receiver needed to ensure the setup time of the receiver. More precisely, flight time is defined as:</p> <p>The time difference between a signal at the input pin of a receiving agent crossing the switching voltage (adjusted to meet the receiver</p>





Term/Acronym	Definition
	<p>manufacturer’s conditions required for AC timing specifications; i.e., ringback, etc.) and the output pin of the driving agent crossing the switching voltage when the driver is driving a test load used to specify the driver’s AC timings.</p> <p>Maximum and Minimum Flight Time - Flight time variations are caused by many different parameters. The more obvious causes include variation of the board dielectric constant, changes in load condition, crosstalk, power noise, variation in termination resistance, and differences in I/O buffer performance as a function of temperature, voltage, and manufacturing process. Some less obvious causes include effects of Simultaneous Switching Output (SSO) and packaging effects.</p> <p>Maximum flight time is the largest acceptable flight time a network will experience under all conditions.</p> <p>Minimum flight time is the smallest acceptable flight time a network will experience under all conditions.</p>
Infrared Data Assoc.	The Infrared Data Association (IrDA) has outlined a specification for serial communication between two devices via a bi-directional infrared data port. The development board has such a port and it is located on the rear of the platform between the two USB connectors.
IMVP6+	The Intel Mobile Voltage Positioning specification for the Intel® Core™ 2 Duo Processor. It is a DC-DC converter module that supplies the required voltage and current to a single processor.
Inter-Symbol Interference	Inter-symbol interference is the effect of a previous signal (or transition) on the interconnect delay. For example, when a signal is transmitted down a line and the reflections due to the transition have not completely dissipated, the following data transition launched onto the bus is affected. ISI is dependent upon frequency, time delay of the line, and the reflection coefficient at the driver and receiver. ISI may impact both timing and signal integrity.
Media Expansion Card	The Media Expansion Card (MEC) provides digital display options through the SDVO interface. The MEC card also incorporates video-in via a x1 PCI Express* port.
Network	The network is the trace of a Printed Circuit Board (PCB) that completes an electrical connection between two or more components.
Overshoot	The maximum voltage observed for a signal at the device pad, measured with respect to VCC.
Pad	The electrical contact point of a semiconductor die to the package substrate. A pad is only observable in simulations.
Pin	The contact point of a component package to the traces on a substrate, such as the motherboard. Signal quality and timings may be measured at the pin.
Power-Good	"Power-Good," "PWRGOOD," or "CPUPWRGOOD" (an active high signal) indicates that all of the system power supplies and clocks are stable. PWRGOOD should go active at a predetermined time after system voltages are stable and should go inactive as soon as any of these voltages fail their specifications.
Ringback	The voltage to which a signal changes after reaching its maximum absolute value. Ringback may be caused by reflections, driver oscillations, or other transmission line phenomena.



Term/Acronym	Definition
System Bus	The System Bus is the microprocessor bus of the processor.
Setup Window	The time between the beginning of Setup to Clock (TSU_MIN) and the arrival of a valid clock edge. This window may be different for each type of bus agent in the system.
Simultaneous Switching Output	Simultaneous Switching Output (SSO) effects are differences in electrical timing parameters and degradation in signal quality caused by multiple signal outputs simultaneously switching voltage levels in the opposite direction from a single signal or in the same direction. These are called odd mode and even mode switching, respectively. This simultaneous switching of multiple outputs creates higher current swings that may cause additional propagation delay ("push-out") or a decrease in propagation delay ("pull-in"). These SSO effects may impact the setup and/or hold times and are not always taken into account by simulations. System timing budgets should include margin for SSO effects.
Stub	The branch from the bus trunk terminating at the pad of an agent.
Trunk	The main connection, excluding interconnect branches, from one end.
System Management Bus	A two-wire interface through which various system components may communicate.
Undershoot	The minimum voltage extending below VSS observed for a signal at the device pad.
VCC (CPU core)	VCC (CPU core) is the core power for the processor. The system bus is terminated to VCC (CPU core).
Victim	A network that receives a coupled crosstalk signal from another network is called the victim network.

[Table 3](#) defines the acronyms used throughout this document.

**Table 3. Acronyms**

Acronym	Definition
AC	Audio Codec
ACPI	Advanced Configuration and Power Interface
ADD2	Advanced Digital Display 2
ADD2N	Advanced Digital Display 2 Normal
AGTL	Assisted Gunning Transceiver Logic
AMC	Audio/Modem Codec.
ASF	Alert Standard Format
AMI	American Megatrends Inc. (BIOS developer)
ATA	Advanced Technology Attachment (disk drive interface)
ATX	Advance Technology Extended (motherboard form factor)
BGA	Ball Grid Array



Acronym	Definition
BIOS	Basic Input/Output System
CK-SSCD	Spread Spectrum Differential Clock
CMC	Common Mode Choke
CMOS	Complementary Metal-Oxide-Semiconductor
CPU	Central Processing Unit (processor)
DDR	Double Data Rate
DMI	Direct Memory Interface
ECC	Error Correcting Code
EEPROM	Electrically Erasable Programmable Read-Only Memory
EHCI	Enhanced Host Controller Interface
EMA	Extended Media Access
EMI	Electro Magnetic Interference
ESD	Electrostatic Discharge
EV	Engineering Validation
EVMC	Electrical Validation Margining Card
FCBGA	Flip Chip Ball Grid Array
FCPGA	Flip Chip Pin Grid Array
FIFO	First In First Out - describes a type of buffer
FS	Full-speed. Refers to USB
FSB	Front Side Bus
FWH	Firmware Hub
GMCH	Graphics Memory Controller Hub
HDA	High Definition Audio
HDMI	High Definition Media Interface
HS	High-speed. Refers to USB
ICH	I/O Controller Hub
IDE	Integrated Drive Electronics
IMVP	Intel Mobile Voltage Positioning
IP/IPv6	Internet Protocol/Internet Protocol version 6
IrDA	Infrared Data Association
ISI	Inter-Symbol Interference
KBC	Keyboard Controller
LAI	Logic Analyzer Interface
LAN	Local Area Network
LED	Light Emitting Diode



Acronym	Definition
LOM	LAN on Motherboard
LPC	Low Pin Count
LS	Low-speed. Refers to USB
LVDS	Low Voltage Differential Signaling
mBGA	Mini Ball Grid Array
MC	Modem Codec
MEC	Media Expansion Card
MHz	Mega-Hertz
OEM	Original Equipment Manufacturer
PCIe	PCI Express*
PCM	Pulse Code Modulation
POST	Power On Self Test
PLC	Platform LAN Connect
RAID	Redundant Array of Inexpensive Disks
RTC	Real Time Clock
SATA	Serial ATA
SIO	Super Input/Output
SKU	Stock Keeping Unit
SMBus	System Management Bus
SODIMM	Small Outline Dual In-line Memory Module
SPD	Serial Presence Detect
SPI	Serial Peripheral Interface
SPWG	Standard Panels Working Group - <a href="http://www.spwg.org/">http://www.spwg.org/</a>
SSO	Simultaneous Switching Output
STR	Suspend To RAM
TCO	Total Cost of Ownership
TCP	Transmission Control Protocol
TDM	Time Division Multiplexed
TDR	Time Domain Reflectometry
μBGA	Micro Ball Grid Array
UDP	User Datagram Protocol
UHCI	Universal Host Controller Interface
USB	Universal Serial Bus
VGA	Video Graphics Adapter
VID	Voltage Identification



Acronym	Definition
VREG	Voltage Regulator
XDP	eXtended Debug Port

## 1.4 Support Options

### 1.4.1 Electronic Support Systems

Intel’s web site (<http://www.intel.com/>) provides up-to-date technical information and product support. This information is available 24 hours per day, 7 days per week, providing technical information whenever you need it.

### 1.4.2 Additional Technical Support

If you require additional technical support, please contact your Intel Representative or local distributor.

## 1.5 Product Literature

In order to order hard copies of product literature the following instructions should be followed:

1. Determine the SKU Number

If you do not know the SKU # of the document you are ordering, please select the back button to view the document again. The SKU # is the first 6 digits of the number on the PDF file, such as: 12345612.pdf or at the bottom of the download page for that document.

2. Call, Mail or Email a request

**Call:** To place an order for a publication or text in hardcopy or CD form, please contact our Intel® Literature Fulfillment Centers listed in [Table 4](#).

**Table 4. Intel Literature Centers**

Location	Telephone Number
U.S. and Canada	1-800-548-4725
International	1-303-675-2148
Fax	1-303-675-2120

**Mail** a request to:



Intel Literature Fulfilment Center  
P.O. Box 5937  
Denver, Colorado 80217-9808  
USA

**Email** a request to: [intelsupport@hibbertgroup.com](mailto:intelsupport@hibbertgroup.com)

Please make sure to include in your mailed/emailed request:

- SKU #
- Company Name
- Your Name (first, last)
- Full mailing address
- Daytime Phone Number in case of questions

**Note:** Please be aware not all documents are available in all media types. Some may only be available as a download.

## 1.6 Related Documents

[Table 5](#) provides a summary of publicly available documents related to this development kit. For additional documentation, please contact your Intel Representative.

**Table 5. Related Documents**

Document Title	Location
Intel® Core™2 Duo Processor for Mobile Intel® 965 Express Chipset Family Datasheet	<a href="http://www.intel.com/design/mobile/datashts/316745.htm">http://www.intel.com/design/mobile/datashts/316745.htm</a>
Mobile Intel® 965 Express Chipset Family Datasheet	<a href="http://www.intel.com/design/mobile/datashts/316273.htm">http://www.intel.com/design/mobile/datashts/316273.htm</a>
Intel® I/O Controller Hub 8 (ICH8) Family Datasheet	<a href="http://www.intel.com/design/chipsets/datashts/313056.htm">http://www.intel.com/design/chipsets/datashts/313056.htm</a>
Intel® Centrino® Pro processor technology and Intel® Centrino® Duo processor technology Design Guide For Intel® Core™2 Duo Mobile Processor, Mobile Intel® 965 Express Chipset Family and Intel® 82801HBM ICH8M & Intel® 82801HEM ICH8M-E I/O Controller Hub Based Systems	Contact your Intel representative for access to this document
Intel® Core™2 Duo Mobile Processor, Mobile Intel® 965 Express Chipset Family and ICH8M I/O Controller Hub Schematics	Contact your Intel representative for access to this document



## 2 Getting Started

This chapter identifies the development kit's key components, features and specifications. It also details basic development board setup and operation.

### 2.1 Overview

The development board consists of a baseboard populated with the Intel® Core™ 2 Duo processor, the Mobile Intel® GME965 Express Chipset, other system board components and peripheral connectors.

**Note:** The development board is shipped as an open system allowing for maximum flexibility in changing hardware configuration and peripherals. Since the board is not in a protective chassis, take extra precaution when handling and operating the system.

#### 2.1.1 Development Board Features

Features of the development board are summarized in [Table 6](#).

**Table 6. Development Board feature Set Summary**

		Development Board Implementation	Comments
F E A T U R E	Processor	Intel® Core™ 2 Duo processor with 4 MByte L2 Cache on 65nm process FSB 533/667/800 MHz support	478 pin Flip Chip Pin Grid Array (Micro-FCPGA) package
	Chipset	Mobile Intel® GME965 Express Chipset (GMCH)	1299-pin Micro-FCBGA Package
		Intel® I/O Controller Hub 8-M Enhanced (ICH8M-E)	676-pin BGA Package
	Memory	Two DDR2 RAM SO-DIMM slots.	Maximum 4GB of DDR2 Memory (RAM) using 1Gb technology and stacked SO-DIMMs.  Supports DDR2 frequency of 533 or 667MHz
	Video	One PCI Express* Graphics Slot One dual channel LVDS Connector One VGA Connector One TV D-Connector supporting S-Video, Composite video and Component video	The Mobile Intel® GME965 Express Chipset (GMCH) has 2 video pipes which allows support of dual independent display.  18-bpp and 24-bpp LVDS panel support  Support for two SDVO channels via x16 PCIe connector (through ADD2 or MEC cards)
PCI	One 5V PCI slot	PCI revision 2.3 compliant (33MHz)	



		Development Board Implementation	Comments
F E A T U R E	PCI Express*	Three x1 connectors One x16 connector	Revision 1.1 compliant There are Five x1 PCI Express* slots but slots 2 and 4 are not intended for use with PCI Express* add-in cards. Only slots 1, 3 and 5 are supported.
	On-Board LAN	10/100/1000 Mbps connectivity from the Intel® 82566MM Gigabit Platform LAN Connect component	The 82566MM is connected to the ICH via the ICH's GLCI and LCI interfaces.
	SPI	Two 16Mbit devices	
	ATA/Storage	PATA 33/66/100	1 Channel
		3 SATA Ports	2 Cable Connector and 1 Direct Connect Connector. RAID 0/1 support.
	USB	10 USB 2.0/1.1 Ports	Five ports provided on rear-panel, four provided via headers (J6H3, J6H3) and one via the PCI Express* docking connector
	LPC	One LPC slot	Includes sideband headers
	BIOS	AMI BIOS installed in an 8Mb FWH	40-pin TSOP socket
	SMC/KBC	Hitachi H8S/2104 micro-controller Two PS/2 ports One scan matrix keyboard connector	ACPI compliant
Clocks	CK-505 clock synthesizer and DB800M clock buffer		
	Super I/O	SMSC SIO1007-JV	Supports IrDA and UART serial interfaces
	RTC	Battery-backed Real Time Clock	
	Thermal Monitoring	Processor temperature sensor	
	Processor Voltage Regulator	IMVP-6+ for processor core	
	Power Supply	Desktop Mode	ATX Power Supply
		Mobile Mode	Battery Pack (smart battery support) AC Mobile Brick
	Debug Interfaces	Port 80 display	Through Add-in card. Four seven-segment displays
		Extended Debug Port (XDP)	XDP connector
	Intel® AMT support	Intel® Active Management Technology 2.5	Supported on the development board with M0, M1, and M-off management states





		Development Board Implementation	Comments
	Power Management	ACPI Compliant	S0 – Power On S3 – Suspend to RAM S4 – Suspend to Disk S5 – Soft Off M0 – All Wells powered M1 – Main Well down. Only ME power on M-off – ME powered off
	Form Factor	ATX 2.2 like form factor	10 layer board – 12" x 10.2"

**Note:** Review the document provided with the Development Kit titled "Important Safety and Regulatory Information". This document contains safety warnings and cautions that must be observed when using this development kit.

## 2.2 Included Hardware and Documentation

The following hardware and documentation is included in the development kit:

- One development board
- One Intel® Core™ 2 Duo processor with 4 MB L2 Cache on 65nm process in the 478 pin Flip-Chip Pin Grid Array (Micro-FCPGA) package (Installed)
- One Firmware Hub (FWH) (Installed)
- One GMCH (GME965) heatsink (Installed)
- One Type 2032, socketed 3 V lithium coin cell battery (Installed)
- One 256 MByte DDR2 SODIMM (200 Pin)
- One CPU thermal solution and CPU back plate (included in kit box – not populated on board)
- One cable kit
- One Development Kit User's Manual
- One Port 80 add-in card

## 2.3 Software Key Features

The driver CD included in the kit contains all of the software drivers necessary for basic system functionality under the following operating systems: Windows\* XP/XP Embedded, Vista and Linux\*.



**Note:** While every care was taken to ensure the latest versions of drivers were provided on the enclosed CD at time of publication, newer revisions may be available. Updated drivers for Intel components can be found at:

<http://developer.intel.com/design/intarch/software/index.htm>

For all third-party components, please contact the appropriate vendor for updated drivers.

**Note:** Software in the kit is provided free by the vendor and is only licensed for evaluation purposes. Refer to the documentation in your evaluation kit for further details on any terms and conditions that may be applicable to the granted licenses. Customers using the tools that work with Microsoft\* products must license those products. Any targets created by those tools should also have appropriate licenses. Software included in the kit is subject to change.

Refer to <http://developer.intel.com/design/intarch/devkits> for details on additional software from other third-party vendors.

### 2.3.1 AMI BIOS

This development kit ships with AMI\* BIOS pre-boot firmware from AMI\* pre-installed. AMI\* BIOS provides an industry-standard BIOS platform to run most standard operating systems, including Windows\* XP/XP Embedded, Linux\*, and others.

The AMI\* BIOS Application Kit (available through AMI\*) includes complete source code, a reference manual, and a Windows-based expert system, BIOSStart\*, to enable easy and rapid configuration of customized firmware for your system.

The following features of AMI\* BIOS are enabled in the development board:

- DDR2 SDRAM detection, configuration, and initialization
- Mobile Intel® GME965 Express Chipset configuration
- POST codes displayed to port 80h
- PCI/PCI Express\* device enumeration and configuration
- Integrated video configuration and initialization
- Super I/O configuration
- CPU microcode update
- Active Management Technology
- RAID 0/1 Support

## 2.4 Before You Begin

The following additional hardware may be necessary to successfully set up and operate the development board.



**VGA Monitor:** Any standard VGA or multi-resolution monitor may be used. The setup instructions in this chapter assume the use of a standard VGA monitor, TV, or flat panel monitor.

**Keyboard:** The development board can support either a PS/2 or USB style keyboard.

**Mouse:** The development board can support either a PS/2 or USB style mouse.

**Hard Drives and Optical Disc Drives:** Up to Three SATA drives and two IDE devices (master and slave) may be connected to the development board. An optical disc drive may be used to load the OS. All these storage devices may be attached to the board simultaneously.

**Video Adapter:** Integrated video is output from the VGA connector on the back panel of the development board. Alternately, a standard PCI Express\* video adapter, ADD2 card or MEC video adapter may be used for additional display flexibility. Please contact the respective vendors for drivers and necessary software for adapters not provided with this development kit. Check the BIOS and the graphics driver, where appropriate, for the proper video output settings.

**Note:** The enclosed driver CD includes drivers necessary for LAN, Integrated graphics, and system INF utilities.

**Network Adapter:** A Gigabit network interface is provided on the development board. The network interface will not be operational until after all the necessary drivers have been installed. A standard PCI/PCI Express\* adapter may be used in conjunction with, or in place of, the onboard network adapter. Please contact the respective vendors for drivers and necessary software for adapters not provided with this development kit.

You must supply appropriate network cables to utilize the LAN connector or any other installed network cards.

**Power Supply:** The development board has the option to be powered from two different power sources: an ATX power supply or AC to DC adapter. The development board contains all of the voltage regulators necessary to power the system.

There are two main supported power supply configurations, Desktop and Mobile. The Desktop solution consists of only using the ATX power supply. The Mobile solution consists of only using the AC to DC adapter.

**Warning:** The power supply cord is the main disconnect device to mains (AC power). The socket outlet shall be installed near the equipment and shall be readily accessible.

**Note:** Desktop peripherals, including add-in cards, will not work in mobile power mode. If desktop peripherals are used, the development board must be powered using desktop power mode.

If using an ATX power supply, select a power supply that complies with the "ATX12V" 1.1 specification. For more information, refer to <http://www.formfactors.org>.

**Note:** If the power button on the ATX power supply is used to shut down the system, wait at least five seconds before turning the system on again to avoid damaging the system.



**Other Devices and Adapters:** The development board functions much like a standard desktop computer motherboard. Most PC-compatible peripherals can be attached and configured to work with the development board.

## 2.5 Setting Up the Development Board

Once the necessary hardware (described in [Section 2.4](#)) has been gathered, follow the steps below to set up the development board.

**Note:** To locate items discussed in the procedure below, please refer to [Chapter 4](#).

1. Create a safe work environment.

Ensure a static-free work environment before removing any components from their anti-static packaging. The development board is susceptible to electrostatic discharge (ESD) damage, and such damage may cause product failure or unpredictable operation. A flame retardant work surface must also be used.

**Caution:** It is recommended that an ESD wrist strap be used when handling the development board.

2. Inspect the contents of your kit.

Check for damage that may have occurred during shipment. Contact your sales representative if any items are missing or damaged.

**Caution:** Since the development board is not in a protective chassis, use caution when connecting cables to this product.

**Caution:** Standby voltage is constantly applied to the development board. Remove power before any hardware (peripherals, keyboards, mice, monitors, accessories, add-in cards, etc) is added or removed from the board.

**Note:** The development board is a standard ATX form factor. An ATX chassis may be used if a protected environment is desired. If a chassis is not used, standoffs must be used to elevate the development board off the working surface to protect the memory and board components from any accidental contact to metal objects.

3. Check the jumper default position setting. Refer to [Figure 7](#) for jumper location. Jumper J5H2 is used to clear the CMOS memory. Make sure this jumper is set to 1-x for normal operation.
4. Be sure to populate the following hardware on your development board:
  - One Intel® Core™ 2 Duo processor
  - One processor thermal solution
  - One 256 MByte DDR2 667 SODIMM (200-pin) into connector J5P1.



**Note:** Ensure that the processor has been locked into the socket by turning the socket screw fully clockwise.

**Note:** For proper installation of the CPU thermal solution, please refer to Appendix A

5. Connect a SATA or IDE hard disk drive.
6. Connect any additional storage devices to the development board.
7. Connect the keyboard and mouse.  
Connect a PS/2-style or USB mouse and keyboard (see Figure 3 on page 38 for connector locations).

**Note:** J1A1 (on the baseboard) is a stacked PS/2 connector. The bottom connector is for the keyboard and the top is for the mouse.

8. Connect an Ethernet cable (optional).
9. Connect the monitor through the VGA connector.
10. Connect the power supply.  
Connect an appropriate power supply to the development board. Make sure the power supply is not plugged into an electrical outlet (turned off). After connecting the power supply board connectors, plug the power supply cord into an electrical outlet.
11. Power up the development board.  
Power and Reset are implemented on the development board through buttons located on SW1C1 and SW1C2, respectively. See [Figure 7](#) for switch locations. Turn on the power to the monitor and development board. Ensure that the fansink on the processor is operating.

**Note:** The power button may have to be pressed twice to turn the power on.

12. Install operating system and necessary drivers.  
Depending on the operating system chosen, all necessary drivers for components included in this development kit can be found on the enclosed CD. Please see [Section 2.3](#) for information on obtaining updated drivers.

## 2.6 Configuring the BIOS

AMI\* BIOS is pre-loaded on the development board. The default BIOS settings may need to be modified to enable/disable various features of the development board. The BIOS settings are configured through a menu-driven user interface which is accessible during the Power On Self Test (POST). The Delete key on the attached keyboard should be pressed during POST to enter the interface. For AMI BIOS POST codes, visit:

<http://www.ami.com>

For BIOS Updates please contact your Intel Sales Representative.

# 3 Theory of Operation

## 3.1 Block Diagram

Figure 1. Development Board Block Diagram

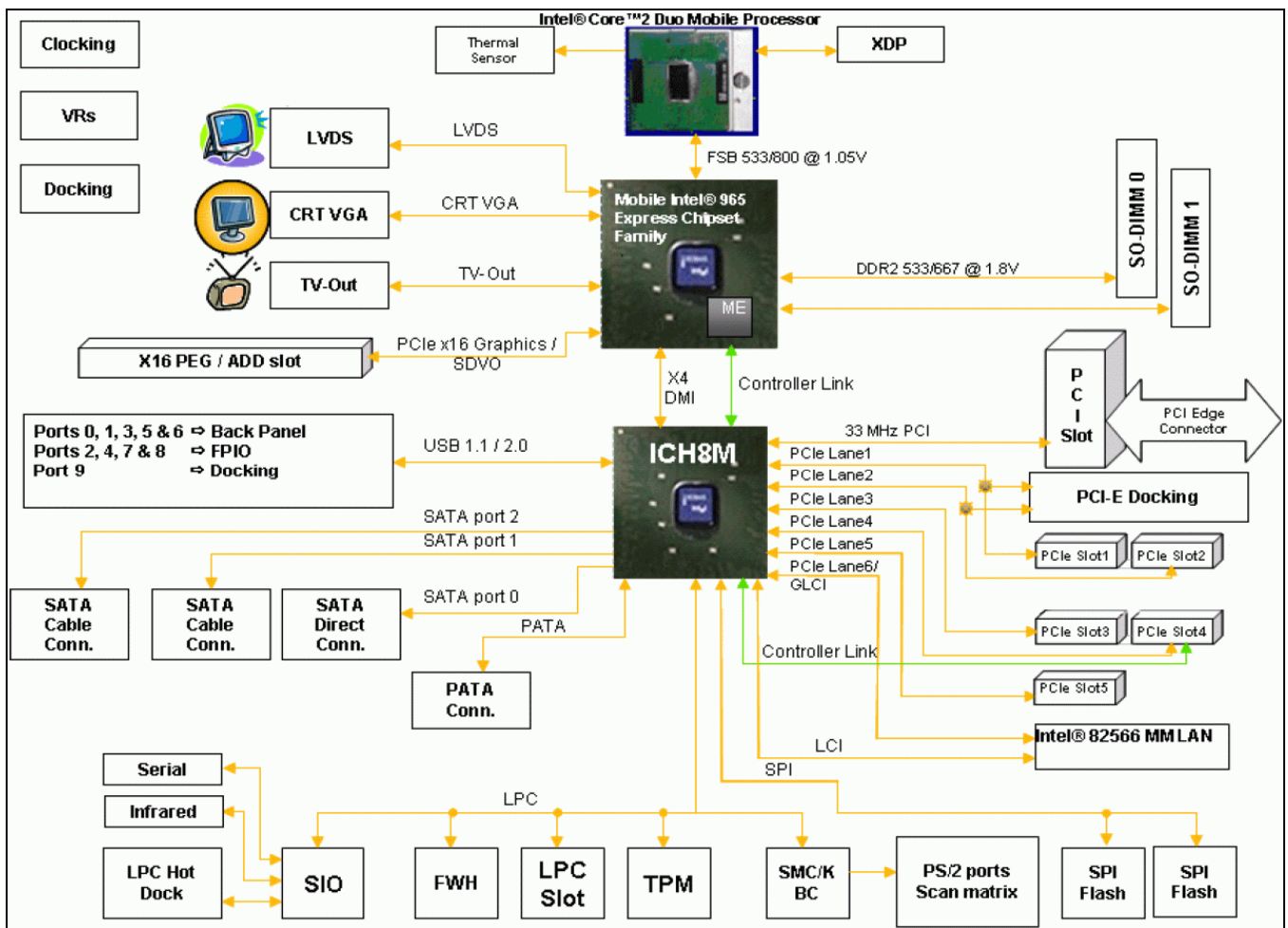

## 3.2 Mechanical Form Factor

The development board conforms to the ATX form factor. For extra protection in a development environment, you may want to install the development board in an ATX



chassis. Internal and rear panel system I/O connectors are described in [Section 3.4](#). An overview of connector and slot locations is provided in [Chapter 4](#).

### 3.3 Thermal Management

The objective of thermal management is to ensure that the temperature of each component is maintained within specified functional limits. The functional temperature limit is the range within which the electrical circuits can be expected to meet their specified performance requirements. Operation outside the functional limit can degrade system performance and cause reliability problems.

The development kit is shipped with a heatsink thermal solution for installation on the processor. This thermal solution has been tested in an open-air environment at room temperature and is sufficient for development purposes. The designer must ensure that adequate thermal management is provided for if the system is used in other environments or enclosures.

### 3.4 System Features and Operation

The following section provide a detailed view of the system features and operation of the development board.

#### 3.4.1 Mobile Intel® GME965 GMCH

The Mobile Intel® GME965 Express Chipset GMCH provides the processor interface optimized for Intel® Core™ 2 Duo processors, system memory interface, DMI and internal graphics. It provides flexibility and scalability in graphics and memory subsystem performance. The following list describes the development board's implementation of the Mobile Intel® GME965 Express Chipset GMCH features.

A list of features follows:

- 1299-ball Micro-FCBGA package
- 533/667/800 MHz Front Side Bus
- 36-bit host bus addressing
- System memory controller (DDR2 implemented)
  - Supports Dual Channel and Single Channel operation
  - Two 200-pin SODIMM slots
  - DDR2 533/667
- Direct Media Interface (DMI)
- Integrated graphics based on the Intel Graphics Media Accelerator X3100
  - Directly supports on-board VGA, TV D-Connector and LVDS interfaces.



- SDVO interface via PCI Express\* x16 connector provides maximum display flexibility
  - Can drive up to two display outputs

### 3.4.1.1 System Memory

The development board supports DDR2 533/667 main memory. Two 200-pin SODIMM connectors (one per channel) on the development board support unbuffered, non-ECC, single and double-sided DDR2 533/667 MHz SODIMMs. These SODIMMs provide the ability to use up to 1 Gbit technology for a maximum of 4 GBytes system memory.

**Note:** Memory that utilizes 128 MBit technology is not supported on the Mobile Intel® GME965 Express Chipset.

**Note:** The SODIMM connectors are on the back side of the development board.

**Caution:** Standby voltage may be applied to the SODIMM sockets when the system is in the S3, S4 and S5 states. Therefore, do not insert or remove SODIMMs unless the system is unplugged.

### 3.4.1.2 DMI

The Mobile Intel® GME965 Express Chipset GMCH's Direct Media Interface (DMI) provides high-speed bi-directional chip-to-chip interconnect for communication with the ICH8-M.

### 3.4.1.3 Advanced Graphics and Display Interfaces

The development board has five options for displaying video: VGA, LVDS, TV-Out, SDVO, or PCI Express\* Graphics. SDVO and PCI Express\* Graphics are multiplexed on the same pins within the Mobile Intel® GME965 Express Chipset. The development board contains one SDVO/PCI Express\* Graphics Slot (J6B2) for a PCI Express\* compatible graphics card or an SDVO compatible graphics card, one LVDS connector (J6F1), one TV-Out connector (J2A1), and one 15-pin VGA connector (J2A2).

#### 3.4.1.3.1 VGA Connector

A standard 15 pin D-Sub connector on the rear panel provides access to the analog output of the Mobile Intel® GME965 Express Chipset. This can be connected to any capable analog CRT or flat panel display with compatible input.

When used in conjunction with the other display options, the displays can operate in Dual Independent mode. This allows unique content to appear on each display at unique refresh rates and timings.

#### 3.4.1.3.2 LVDS Flat Panel Interface

The development board provides one 50-pin LVDS video interface connector. The interface is compliant with the SPWG 3.5 (for 18-bpp panels) and proposed SPWG 4.0 (for 24-bpp panels) standards.





#### 3.4.1.4 PCI Express x16 Slot

The development board provides access to one x16 PCI Express\* connector. Any industry standard x1 or x16 PCI Express\* video adapter may be used with this interface. Additionally, any industry standard non-graphics x1, x4 or x8 adapter may also be used. x2 adapters are not part of the PCI Express\* specification but x2 non-graphics devices are also supported.

**Note:** The AMI BIOS that is included with the development board is configured to allow x2, x4 and x8 non-graphics support through the x16 PCI Express\* connector. If the user wishes to use another BIOS on the development board then the BIOS may need to be modified to support this feature.

### 3.4.2 ICH8-M

The ICH8-M is a highly integrated multifunctional I/O controller hub that provides the interface to the system peripherals and integrates many of the functions needed in today's PC platforms. The following sections describe the development board implementation of the ICH8-M features, which are listed below:

- Three PCI Express\* (x1) connectors
- One PCI connectors
- LPC interface
- System Bus Management
- ACPI\* 3.0 compliant
- Real Time Clock
- 676-ball mBGA package
- Three SATA drive connectors
- One IDE connector
- Ten Universal Serial Bus (USB) 2.0 ports (five ports provided on rear-panel, four provided via headers (J6H3, J6H4) and one on the docking connector.

#### 3.4.2.1 PCI Express\* Slots

The development board has three x1 PCI Express\* slots for add-in cards. The PCI Express\* interface is compliant to the PCI Express\* Rev. 1.1 Specification.

**Note:** There are actually Five x1 PCI Express\* slots but slots 2 and 4 are not intended for use with PCI Express\* add-in cards. Only slots 1, 3 and 5 are supported.

#### 3.4.2.2 PCI Slots

The development board has one 5V PCI slot for add-in cards. The PCI bus is compliant to the PCI Rev. 2.3 Specification at 32-bit/33 MHz



### 3.4.2.3 On-Board LAN

The development board has one RJ-45 interface – at connector J5A1 - through which 10/100/1000 ethernet is available. The ethernet MAC is located in the ICH8-M and the PHY is located externally in the 82566MM LAN Connect Interface (LCI) device. The 82566MM is connected to the ICH8-M via two interfaces: LCI for 10/100 Mbps traffic and GLCI (Gigabit LCI) for 1000Mbps traffic. Intel® Active Management Technology is optionally supported through these components.

Information on Intel® Active Management Technology can be found at:  
<http://www.intel.com/technology/manage/iamt/>

**Note:** Further details on the location of the RJ-45 interface can be found in [Section 4.2](#).

### 3.4.2.4 High Definition Audio

Intel® High Definition Audio is not supported on the development board.

### 3.4.2.5 ATA/ Storage

The development board has one parallel ATA IDE connector and three serial ATA connectors.

The parallel ATA IDE Connector is a standard 40-pin connector at J7J4. This connector supports up to two Ultra ATA/100 hard drives; one master and one slave.

There are three SATA connectors on the development board – one 'Direct Connect' connector and two 'Cable Connect' connectors. The 'Direct Connect' connector, located at J8J1, provides both signaling and power while the 'Cable Connect' connectors, located at J7H1 and J7J3, only provides signals (the user typically uses an ATX power supply for the drive power). A green LED at location CR6J1 indicates activity on the ATA channel.

The development board also supports 'ATA swap' capability for both the parallel IDE channel and the serial ATA channels. A device can be powered down by software and the port can then be disabled, allowing removal and insertion of a new device. The parallel IDE device should be powered from the power connector, J4J2, on the development board to utilize the hot swap feature. This feature requires customer-developed software support.

**Note:** Desktop hard drives must be powered using the external ATX power supply, not the onboard power supply.

The Mobile Intel® GME965 Express Chipset includes Intel® Matrix Storage Technology, providing greater performance and reliability through features such as Native Command Queuing (NCQ) and RAID 0/1. For more information about Intel® Matrix Storage Technology, refer to Intel's website at:

[http://www.intel.com/design/chipsets/matrixstorage\\_sb.htm](http://www.intel.com/design/chipsets/matrixstorage_sb.htm)

### 3.4.2.6 USB Connectors

The ICH8-M provides a total of ten USB 2.0 ports. Three ports are routed to a triple-stack USB connector at J3A1. Two ports are routed to a combination RJ-45/dual USB



connector at J5A1. Four ports are routed to USB front panel headers at J6H3 and J6H4. The last is routed to the PCI-Express\* docking connector at J9C1.

There are Five UHCI Host Controllers and two EHCI Host Controllers. Each UHCI Host Controller includes a root hub with two separate USB ports each, for a total of ten legacy USB ports. The first EHCI Host Controller includes a root hub that supports up to six USB 2.0 ports and the second EHCI Host Controller includes a root hub that supports up to four USB 2.0 ports.

The connection to either the UHCI or EHCI controllers is dynamic and dependant on the particular USB device. As such, all ports support High Speed, Full Speed, and Low Speed (HS/FS/LS).

#### 3.4.2.7 LPC Super I/O (SIO)/LPC Slot

An SMSC SIO1007-JV serves as the SIO on the development board. Shunting the jumper at J7D1 to the 2-3 positions can disable the SIO by holding it in reset. This allows other SIO solutions to be tested in the LPC slot at J8E1. A sideband header is provided at J9G1 for this purpose. This sideband header also has signals for LPC power management. Information on this header is on sheet 44 of the development board schematics.

#### 3.4.2.8 Serial, IrDA

The SMSC SIO incorporates a serial port, and IrDA (Infrared), as well as general purpose IOs (GPIO). The Serial Port connector is provided at J2A2, and the IrDA transceiver is located at U4A1. The IrDA transceiver on the development board supports SIR (slow IR), FIR (Fast IR) and CIR (Consumer IR). The option to select between these is supported through software.

#### 3.4.2.9 BIOS Firmware Hub (FWH)

An 8-Mbit Flash device used on the development board to store system and video. The reference designator location of the FWH device is U8G1. The BIOS can be upgraded using an MS-DOS\* based utility called FWHFlash and is addressable on the LPC bus off of the ICH8-M. FWHFlash is available on request from your Intel representative.

#### 3.4.2.10 SPI

The Serial Peripheral Interface on ICH8-M is used to support two compatible flash devices at locations U7E1 and U6D2. By default, the SPI flash is used to store configuration data for the LAN controller. Optionally it may be used for BIOS and AMT firmware storage.

It is necessary to set certain strapping options to enable either a FWH-based or SPI-based BIOS. Optionally, it is also possible to direct BIOS access to the PCI interface. [Table 7](#) describes these strapping options.



Table 7. BIOS Location Strapping Options

ICH8-M Signal		
GNT#0	SPI_CS1#	BIOS Location
0	1	SPI
1	0	PCI
1	1	LPC (Default)

**Note:** GNT#0 is configurable via jumper J8E2. Further details on its location can be found in [Section 4.3](#). SPI\_CS1# is configurable via stuffing option R7U12. By default R7U12 is not stuffed resulting in a SPI\_CS1# strapping value of 1.

#### 3.4.2.11 System Management Controller (SMC)/Keyboard Controller

The Hitachi\* H8S/2104RV serves as both SMC and KBC for the development board. The SMC/KBC controller supports two PS/2 ports, battery monitoring and charging, EMA support, wake/runtime SCI events, and power sequencing control. The two PS/2 ports on the development board are for legacy keyboard and mouse. The keyboard plugs into the bottom jack and the mouse plugs into the top jack at J1A1. Scan matrix keyboards can be supported via an optional connector at J9E1.

#### 3.4.2.12 Clocks

The development board uses a CK-505 clock synthesizer and DB800 clock buffer compatible solution. The FSB frequency is determined from decoding the processor BSEL[2:0] pin settings. This pin settings may be strapped using the jumpers at J1G2, J1G5 and J1G8. Refer to [Figure 7](#) and [Table 15](#) for further information on these jumpers.

#### 3.4.2.13 Real Time Clock

An on-board battery at BT5H1 maintains power to the real time clock (RTC) when in a mechanical off state. A CR2032 battery is installed on the development board.

**Warning:** Risk of explosion if the lithium battery is replaced by an incorrect type. Dispose of used batteries according to the vendor's instructions.

#### 3.4.2.14 Thermal Monitoring

The processor has a thermal diode for temperature monitoring. The SMC throttles the processor if it becomes hot. If the temperature of the processor rises too high, the SMC alternately blinks the CAPS lock and NUM lock LEDs on the development board, and the development board shuts down.

A 3-pin fan header J3C1 is provided to support Tachometer output measurement for GMCH. The development board supports PWM based speed control. As part of the thermal measurement, the speed of the fan is varied based on the temperature measurement.



### 3.4.3 POST Code Debugger

A Port 80-83 Add-in card can be plugged into to the development board at the TPM header (J9A1). This card decodes the LPC bus BIOS POST codes and displays them on four 7-segment LED displays.

For AMI\* BIOS POST codes, please visit: <http://www.ami.com>

## 3.5 Clock Generation

The development board uses a CK-505 and DB800 compatible solution. The FSB frequency is determined from decoding the processor BSEL[2:0] pin settings.

The clock generator provides Processor, GMCH, ICH8-M, PCI, PCI Express\*, SATA, and USB reference clocks. Clocking for DDR2 is provided by the GMCH.

**Table 8. Primary System Clocks**

Clock Name	Speed
CPU	133 MHz @ 533 FSB Speed 166 MHz @ 667 FSB Speed 200 MHz @ 800 FSB Speed
DDR2	133 MHz @ 533 Memory Speed 166 MHz @ 667 Memory Speed
PCI Express* and DMI	100 MHz
SATA	100MHz
PCI	33MHz
USB	48MHz
Super I/O	14MHz

## 3.6 Power Management States

[Table 9](#) and [Table 10](#) lists the power management states that have been defined for the baseboard.

The Manageability Engine (ME) operates at various power levels, called M-states. M0 is the highest power state, followed by M1 and M-off. The Manageability Engine provides some of the functionality required to implement Intel® Active Management Technology (iAMT) on the development board. Further information on iAMT can be found here: <http://www.intel.com/technology/manage/iamt/>

**Table 9. Power Management States**

State	Description
G0/S0/C0	Full on
G0/S0/C2	STPCLK# signal active



State	Description
G0/S0/C3	Deep Sleep: DPSP# signal active
G0/S0/C4	Deeper Sleep: DPRSP# signal active
G1/S3	Suspend To RAM (all switched rails are turned off)
G1/S4	Suspend To Disk
G2/S5	Soft Off
G3	Mechanical Off

**Table 10. Power Management M-States**

M-State	Description	Main System	Memory Subsystem <sup>1</sup>	Manageability Subsystem <sup>2</sup>	Clocks
M0	Full on. All manageability functions supported	Powered	Powered and active	Powered	Powered
M1	Manageability functions that only require memory are supported	Off	Powered - Self refresh.	Powered	Only BCLK pair to MCH is active <sup>3</sup>
M-off	Manageability is disabled	Off	Off	Off	Off

**NOTES:**

1. Memory subsystem is the memory and memory-related power supplies to the MCH.
2. Manageability Subsystem includes manageability functions in the chipset, SPI flash, and LAN devices.
3. In M1 the clock is powered, however only the BCLK pair to the MCH is active. Everything besides the PLL in the clock chip is disabled and powered down.

**Note:** While in an M-state other than M-off, the traditional hardware definition of the S-State as defined by the SLP signals is overridden by the ICH8M. This allows devices controlled by SLP\_S3# and SLP\_S4#, such as system memory, to be available to the Manageability system as needed. Even though the SLP signals may be driven differently in M-States, the S-State information is retained in the ICH8M for transition to M-off. S4\_STATE# is the new signal to indicate S4 transition.

[Table 11](#) provides a truth table of the SLP signals in various system states and M-States. The ICH8M provides all of the SLP signals shown in the table below.



Table 11. Sleep Signals and M-State Definition

		Signal				
		SLP_S3#	SLP_S4#	SLP_S5#	S4_STATE#	SLP_M#
State	S0/M0	High	High	High	High	High
	S3/M1	Low	High	High	High	High
	S4/M1	Low	High	High	Low	High
	S5/M1	Low	High	Low	Low	High
	S3/M-off	Low	High	High	High	Low
	S4/M-off	Low	Low	High	Low	Low
	S5/M-off	Low	Low	Low	Low	Low
	S0 (Non-AMT)	High	High	High	High	High
	S3 (Non-AMT)	Low	High	High	High	Low
	S4 (Non-AMT)	Low	Low	High	Low	Low
	S5 (Non-AMT)	Low	Low	Low	Low	Low

### 3.7 Power Measurement Support

Power measurement resistors are provided on the development board to measure the power of most subsystems. All power measurement resistors have a tolerance of 1%. The value of these power measurement resistors are 0.002Ω by default. Power on a particular subsystem is calculated using the following formula:

$$P = \frac{V^2}{R}$$

R = value of the sense resistor (typically 0.002Ω)

V = the voltage difference measured across the sense resistor

Use of an oscilloscope or high precision digital multi-meter tool such as the Agilent\* 34401A digital multi-meter is recommended. Meters such as this have 6½ digits of accuracy and can provide a much greater accuracy in power measurement than a common 3½ digit multi-meter.

[Table 12](#) summarizes all the power measurement resistors located on the development board. All resistors are 0.002 Ω unless otherwise noted. Reference designators marked with an asterisk are “not stuffed” on the development board.



Table 12. Development Board Voltage Rails

Component / Interface	Voltage Plane	Supply	Rail	Reference Designator
CPU VR	5V	+V5S	+V5S_IMVP6	R1B1
CPU VR	Battery	+VBAT	+VDC_PHASE	R2P12
CPU VR	Variable	6208_1_PHASE_LOUT	+VCC_CORE	R3D1
CPU VR	Variable	6208_2_PHASE_LOUT	+VCC_CORE	R2D1
CPU VR	Variable	6208_3_PHASE_LOUT	+VCC_CORE	R2D2
CPU	1.05V	+V1.05S	+V1.05S_CPU	R3T2* and R3R7*
CPU	1.5V	+V1.5S	+VCCA_PROC	R3U1 (0.01Ω)
GMCH VR	Battery	+VBATA	1.5S_VIN	R5V3
GMCH VR	Battery	+VBATA	VGMCH_IN	R5F16
GMCH VR	5 V	+V5S	+V5S_GVR	R3F12
GMCH VR	Battery	+VBAT	GVR_VBAT	R3V2
GMCH VR	3.3V	V3.3S_TVDAC_R2	+V3.3S_TVDAC	R3E2 (0.01Ω)
GMCH VR	Battery	+VBATA	V1.25M_VIN	R4V4
GMCH VR	1.05 V	+V1.05OUT	+V1.05M	R4F13 (0.01Ω)
GMCH	1.05V	+V1.05S	+VCC_GMCH	R6E1
GMCH	VCCP (1.05V)	+V1.05S	+VCCP_GMCH	R5U26
GMCH	1.05V	+V1.05S	+VCC_PEG	R6T14
GMCH	1.25S	+V1.25S	+VCC_PEG	R6T13*
GMCH	1.05V	+V1.05S	+VCC_DMI	R6T11
GMCH	1.25S	+V1.25S	+VCC_DMI	R6E2*
GMCH	1.05V	+V1.05M	+VCC_AXM	R6R1
GMCH	V_GFX (1.05S)	+VCC_GFXCORE	+VCC_GFX	R3F8
GMCH	1.25V	+V1.25S	+V1.25S_PEGPLL	R5E3
GMCH	1.25V	+V1.25M	+V1.25M_A_SM_CK	R5P5
GMCH	1.25V	+V1.25S	+V1.25S_DMI	R6D5
GMCH	1.25V	+V1.25S	+V1.25S_MCH_PLL	R5U24
GMCH	1.25V	+V1.25M	V1.25M_MCH_PLL2	R4D6
GMCH	1.25V	+V1.25M	+V1.25M_A_SM	R4R2
GMCH	1.25V	+V1.25M	+V1.25M_AXD	R4C27
GMCH	1.25V	+V1.25S	+V1.25S_AXF	R4F9
GMCH	1.5V	+V1.5S	TVDAC_FB	R5U8





Component / Interface	Voltage Plane	Supply	Rail	Reference Designator
GMCH	1.8V	+V1.8	+V1.8_GMCH	R5D1
GMCH	1.8V	+V1.8_GMCH	+V1.8_SM_CK	R5D2
GMCH	1.8V	+V1.8	+V1.8_TXLVDS	R5U25
GMCH	1.8V	+V1.8	+V1.8_DLVDSD	R5E5
GMCH	3.3V	+V3.3S	+V3.3S_HV	R5U2
GMCH	3.3V	+V3.3S	+V3.3S_SYNC	R5F9
GMCH	3.3V	+VCCA_TVDDAC	+V3.3S_DAC_BG	R5U19 (0.03Ω)
GMCH	3.3V	+V3.3S	+V3.3S_PEG_BG	R6E3
PCI-E Gfx	3.3V	+V3.3S	+V3.3S_PEG	R6C1
PCI-E Gfx	3.3V	+V3.3	+V3.3S_PEG	R6P2*
PCI-E Gfx	Battery	+VBATS	+V12S_PEG	R6N9
PCI-E Gfx	Battery	+VBAT_S4	+V12S_PEG	R6N5*
ICH	1.05V	+V1.05S	+V1.05S_ICH	R7F12
ICH	1.05V	+V1.05S	+V1.05S_ICH_IO	R6V11
ICH	1.25V	+V1.25S	+V1.25S_DMI_ICH	R6G3
ICH	1.5V	+V1.5S	+V1.5S_PCIE_ICH	R6F13
ICH	1.5V	+V1.5S	+V1.5S_SATA_ICH	R8G2
ICH	1.5V	+V1.5S	+V1.5S_USB_ICH	R8F7
ICH	1.5V	+V1.5S	+V1.5S_APLL_ICH	R8G2
ICH	3.3V	+V3.3S	+V3.3S_DMI_ICH	R6G4
ICH	3.3V	+V3.3S	+V3.3S_GLAN_ICH	R6F2
ICH	3.3V	+V3.3M	+V3.3M_ICH	R7U3
ICH	3.3V	+V3.3A	+V3.3A_ICH	R6V12
ICH	3.3V	+V3.3A	+V3.3A_USB_ICH	R8F4
ICH	3.3V	+V3.3S	+V3.3S_IDE_ICH	R8G1
ICH	3.3V	+V3.3S	+V3.3S_VCCPCORE_ICH	R8V14
ICH	3.3V	+V3.3M	+V3.3M_VCCPAUX	R7F1
ICH	3.3V	+V3.3S	+V3.3S_PCI_ICH	R8F5
ICH	3.3V	+V3.3S	+V3.3S_SATA_ICH	R8G7
ICH	3.3V	+V3.3S_1.5S_HDA_IO	+V3.3S_1.5S_HDA_IO_ICH	R7V4 (0.022Ω)
Memory	Battery	+VBATA	1.8_VIN	R5N13
Memory	0.9 V	+V0.9	+V0.9_R	R4B13
Memory	1.8V	+V1.8	+V1.8_DIMM0	R5C2



Component / Interface	Voltage Plane	Supply	Rail	Reference Designator
Memory	1.8V	+V1.8	+V1.8_DIMM1	R5B10
Memory	3.3V	+V3.3M	+V3.3M_DIMM0	R4C1 (0.022Ω)
Memory	3.3V	+V3.3M	+V3.3M_DIMM1	R4B26 (0.022Ω)
LAN	3.3V	+V3.3M_LAN_SW	+V3.3M_LAN	R6A23
LAN	1.8V	+V1.8_LAN	+V1.8_LAN_M	R6M1
LAN	1V	+V1.0_LAN_M	+V1.0_LAN_M_IN	R6M3
PCI	3.3V	+V3.3S	+V3.3S_PCI	R9D2
PCI	3.3V	+V3.3	+V3.3_PCISLT3	R8C5*
PCI	3.3V	+V3.3S_PCI	+V3.3_PCISLT3	R9D3
PCI	5V	+V5S	+V5S_PCI	R9B1
PCI	5V	+V5	+V5_PCISLT3	R8B3*
PCI	5V	+V5S_PCI	+V5_PCISLT3	R9B2
PCI	5V	+V5	+V5_PCI	R9A11*
PCI	12V	+V12S	+V12S_PCI	R8B1
PCI-E	12V	+V12S	+V12S_PCIESLOT1	R7N11
PCI-E	12V	+V12S	+V12S_PCIESLOT2	R7C20
PCI-E	12V	+V12S	+V12S_PCIESLOT3	R8B2
PCI-E	12V	+V12S	+V12S_PCIESLOT4	R8C7
PCI-E	12V	+V12S	+V12S_PCIESLOT5	R7N9
PCI-E	3.3V	+V3.3S	+V3.3S_PCIESLOT1	R7N10
PCI-E	3.3V	+V3.3S	+V3.3S_PCIESLOT2	R7R1
PCI-E	3.3V	+V3.3S	+V3.3S_PCIESLOT3	R7N5
PCI-E	3.3V	+V3.3S	+V3.3S_PCIESLOT4	R8D2
PCI-E	3.3V	+V3.3S	+V3.3S_PCIESLOT5	R7N8
Audio	3.3 V	+V3.3S	+V3.3S_1.5S_HDA_IO	R7W5
Audio	1.5 V	+V1.5S	+V3.3S_1.5S_HDA_IO	R7H6*
Audio	1.5 V	+V1.5A_HDA_IO	+V3.3A_1.5A_HDA_IO	R8E8*
Audio	3.3 V	+V3.3A	+V3.3A_1.5A_HDA_IO	R8E7
Panel Bklt	5V	+V5S	+V5S_LVDS_BKLT	R6U8
Panel Bklt	Battery	+VBAT	+VCC_LVDS_BKLT	R6F1
Panel LVDS	3.3V	+V3.3S	+V3.3S_L	R6U13
Panel LVDS	5V	+V5S	+V3.3S_L	R6U16*
Panel LVDS	3.3V	+V3.3S	+V3.3S_LVDS_DDC	R6F9



Component / Interface	Voltage Plane	Supply	Rail	Reference Designator
Panel LVDS	5V	+V5S	+V3.3S_LVDS_DDC	R6U9*
CK505	3.3V	+V3.3M_CK505	VDD_CK505	R5G11
CK505	3.3V	+V3.3S	+V3.3S_DB800	R7C10
CK505	0.9V	IO_VOUT_D	+VDDIO_CLK	R5V11
LPC	3.3V	+V3.3	+V3.3_LPCSLOT	R8F2
LPC	5V	+V5	+V5_LPCSLOT	R8E2
TPM	5V	+V5	V5_R1_TPM	R9M7
TPM	3.3V	+V3.3S	V3.3S_R1_TPM	R9M8
TPM	3.3V	+V3.3A	V3.3A_R1_TPM	R9A8
SMC	3.3V	+V3.3A	+V3.3A_KBC	R8H1
PS2	5V	+V5	+V5_PS2	R1A1
SIO	3.3V	+V3.3S	+V3.3S_SIO	R7E1
IR	3.3V	+V3.3S	+V3.3S_IR	R4M3
FWH	3.3V	+V3.3S	+V3.3S_FWH	R8V17
USB	5V	+V5A	+V5A_USBPWR_IN1	R5W9
USB	5V	+V5A	+V5A_USBPWR_IN2	R7H7
USB	5V	+V5A	+V5A_USBPWR_IN3	R3B5
IDE	5V	+V5S	+V5S_PATA	R5Y6
IDE	12V	+V12S	+V12S_PATA	R3Y2
SPI	3.3V	+V3.3M	+V3.3M_SPI	R6D8
SATA	3.3V	+V3.3S	+V3.3S_SATA_P0	R8Y2
SATA	5V	+V5S	+V5S_SATA_P0	R8H6
SATA	12V	+V12S	+V12S_SATA_P0	R8W11
SATA	3.3V	+V3.3S	+V3.3S_SATA_P1	R7H9
SATA	5V	+V5S	+V5S_SATA_P1	R8H7
SATA	12V	+V12S	+V12S_SATA_P1	R8H2
System	Battery	+VCHGR_OUT	+VBS	R1W15 (0.02Ω)
System	Battery	+V_BC_OUT	+VBS	R2H5 (0.005Ω)
System	Battery	+VBATA	51120DRVH1_+VBATA	R3H20
System	Battery	+VBATA	51120DRVH2_+VBATA_Q	R3H5
System	3.3V	51120VBST2_LR	+V3.3A_MBL	R3G3
System	5V	'51120_+V5A_MBL_QL	+V5A_MBL	R3J1
System	1.25V	+V1.25M_OUT	+V1.25M	R4V2
System	1.5V	+V1.5S	+V1.5S_SW	R5G23



Component / Interface	Voltage Plane	Supply	Rail	Reference Designator
System	ATX	+V5A	+V5_ATX	R4J1*
System	ATX	+V3.3A	+V3.3_ATX	R4W23*
System	ATX	+V12_ATX	+VBATA	R4Y1
System	ATX	-V12_ATX	-V12A	R4Y2
System	ATX	+V5SB_ATX	+V5SB_ATXA	R5H17
System	+VAC_B RCK	+VAC_BRCK_IN	NEG_SENSE	R1G8

§



## 4 Hardware Reference

This section provides reference information on the hardware, including locations of development board components, connector pinout information and jumper settings.

### 4.1 Primary Features

[Figure 2](#) shows the major components of the development board and [Table 13](#) gives a brief description of each component.

**Figure 2. Development Board Component Locations**

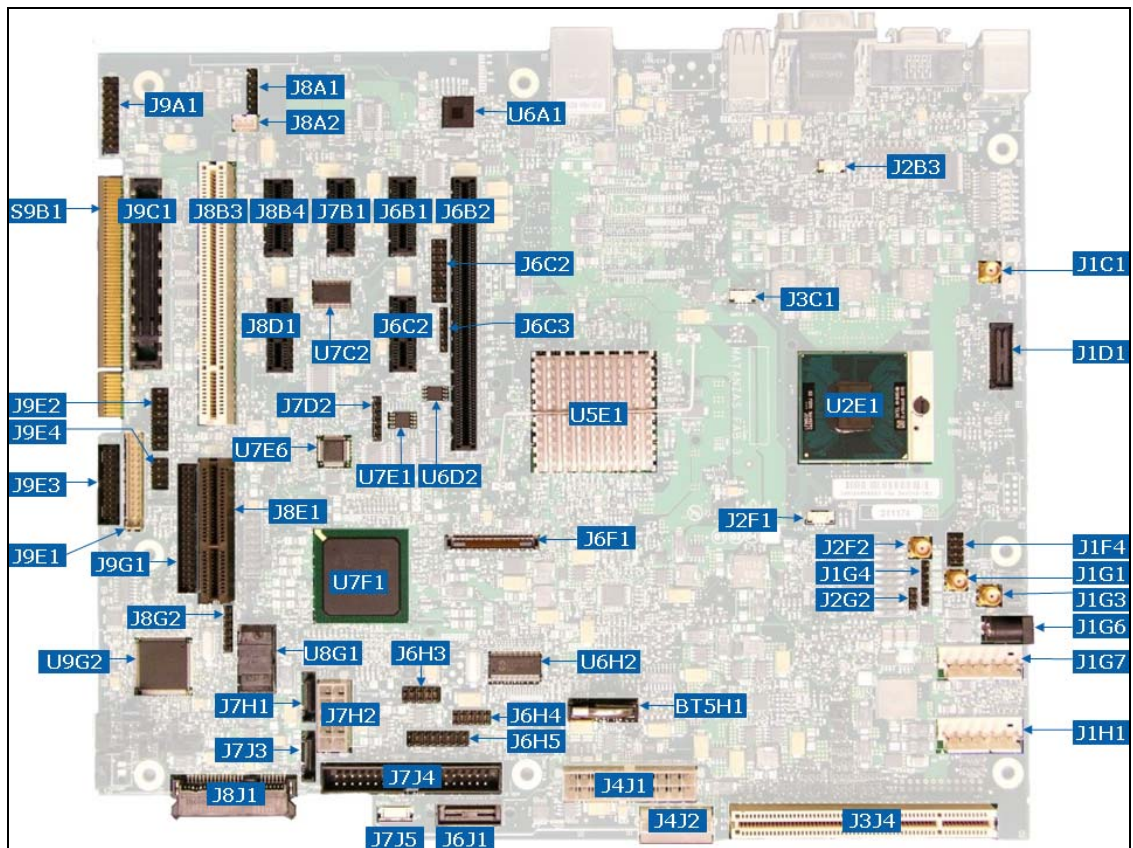



**Table 13. Development Board Component Location Legend**

Reference Designator	Function
BT5H1	CMOS Battery
J1C1	Reserved
J1D1	XDP Connector
J1F4	CPU FSB Sideband Signals
J1G1	Reserved
J1G3	Reserved
J1G4	Reserved
J1G6	AC Brick Connector
J1G7	Battery Connector B
J1H1	Battery Connector A
J2B3	CPU Fan Connector
J2F1	Reserved
J2F2	Reserved
J2G2	Reserved
J3C1	GMCH Fan Connector
J3J4	Reserved
J4J1	ATX Power Connector
J4J2	PATA Power Connector
J6B1	PCI Express Slot 1
J6B2	PCI Express x16 Graphics Port
J6C2	HDA Header for External HDMI Support
J6C3	Reserved
J6F1	LVDS Connector
J6H3	USB Ports 7 and 8
J6H4	USB Ports 2 and 4
J6H5	Front Panel Header
J6J1	Reserved
J7B1	PCI Express Slot 5
J7D2	Reserved
J7H1	SATA Port 2, Cable Connect
J7H2	SATA Power Connector
J7J3	SATA Port 1, Cable Connect



Reference Designator	Function
J7J4	PATA Connector
J8A1	Reserved
J8A2	Reserved
J8B3	PCI Slot 3
J8B4	PCI Express Slot 3
J8D1	PCI Express Slot 4
J8E1	LPC Slot
J8G2	Extended Mobile Access Header
J8J1	SATA Port 0, Direct Connect
J9A1	Trusted Platform Module Header
J9C1	PCI Express Docking Interface
J9E1	Scan Matrix Key Board Connector
J9E2	HDA Header for MDC Interposer
J9E3	LPC Hot Docking Connector
J9E4	HDA Header for MDC Interposer
J9G1	LPC Side Band Header
S9B1	PCI-Edge Connector
U2E1	Intel® Core™ 2 Duo processor
U5E1	Mobile Intel® GME965 Express Graphics Memory Controller Hub
U6A1	82566MM Gigabit Ethernet Phy
U6D2	16Mb SPI Flash
U6H2	CK505 Clock Synthesizer
U7C2	DB800 Clock Buffer
U7E1	16Mb SPI Flash
U7E6	Super I/O
U7F1	Intel® I/O Controller Hub 8-M (ICH8-M)
U8G1	Firmware Hub
U9G2	H8S/2104 KSC

## 4.2 Back Panel Connectors

This section describes the panel connectors on the development board. [Figure 3](#) shows these connectors.

Figure 3. Back Panel Connector Locations

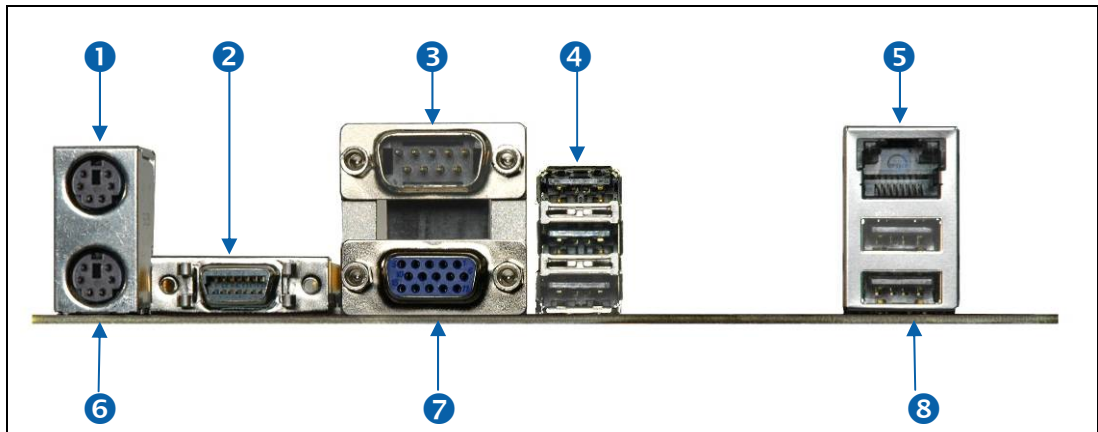

Table 14. Back Panel Connector Definitions

Item	Description	Ref Des	Item	Description	Ref Des
1	PS/2 Mouse	J1A1	5	RJ-45 LAN	J5A1
2	TV-Out D-Connector	J2A1	6	PS/2 Keyboard	J1A1
3	Serial Port	J2A2	7	VGA	J2A2
4	3 USB Ports	J3A1	8	2 USB Ports	J5A1

### 4.2.1 TV-Out D-Connector

The TV-Out D-connector supplies the necessary signals to support the Composite, S-Video, and Component TV standards. Component video ([Figure 4](#)) and Composite video ([Figure 5](#)) is connected to the development board using D-connector to Component Video cable (with three RCA receptacles at one end and D-mating connector on other end). S-video ([Figure 6](#)) is connected to development board using D-connector to S-Video cable (with 4-pin DIN connector one end and D-mating connector on other end).





Figure 4. D-Connector to Component Video Cable

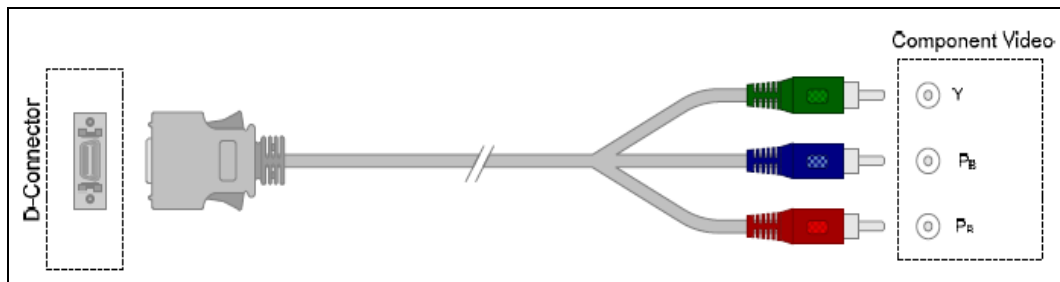

Figure 5. D-Connector to Composite Video Cable

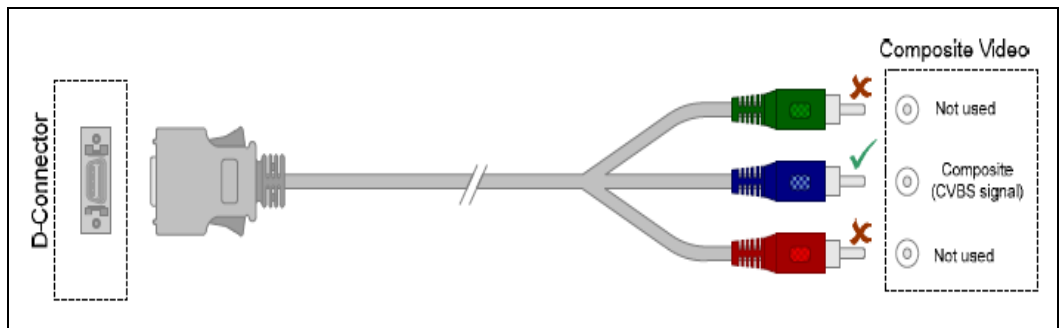
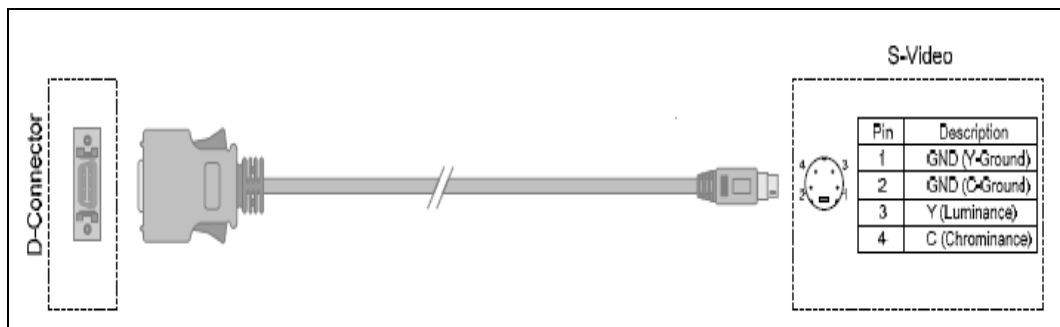

Figure 6. D-Connector to S-Video Cable



### 4.3 Configuration Settings

**Note:** Do not move jumpers with the power on. Always turn off the power and unplug the power cord from the computer before changing jumper settings. Failure to do so may cause damage to the development board.

[Figure 7](#) shows the location of the configuration jumpers and switches.

[Table 15](#) summarizes the jumpers and switches and gives their default and optional settings.

The unsupported jumpers must remain in their default position or the operation of the development board is unpredictable. The development board is shipped with the jumpers and switches shunted in the default locations.

Figure 7. Configuration Jumper and Switch Locations

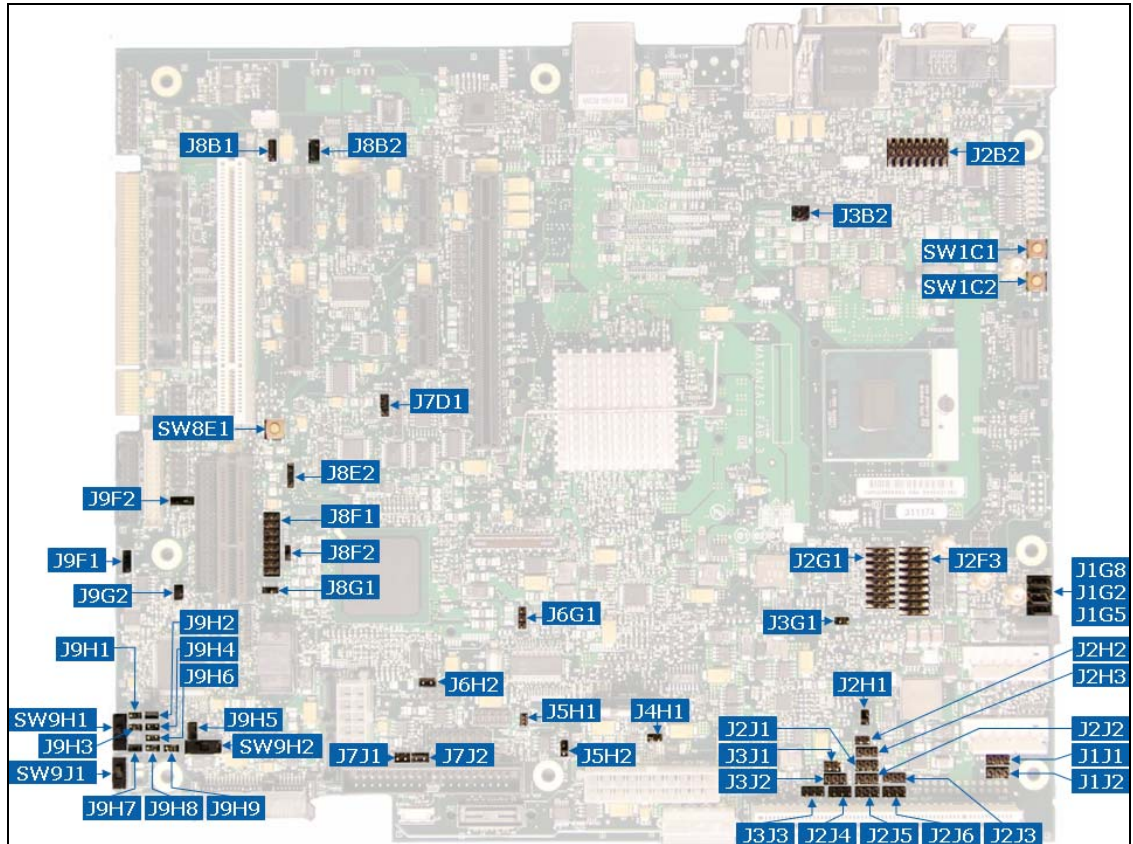

Table 15. Supported Configuration Jumper/Switch Settings

Reference Designator	Function	Default Setting	Optional Setting
J1G2	BSEL0	1-2: Processor BSEL Select	2-3: Tied to logic high Empty: Tied to logic low
J1G5	BSEL1	1-2: Processor BSEL Select	2-3: Tied to logic low Empty: Tied to logic high
J1G8	BSEL2	1-2: Processor BSEL Select	2-3: Tied to logic low Empty: Tied to logic high
J1J1	Reserved	OUT Do not alter jumper setting	
J1J2	Reserved	OUT Do not alter jumper setting	
J2B2	CPU VID Code	OUT	15-16: Activate Override



Reference Designator	Function	Default Setting	Optional Setting
	Override		For each VID signal IN: Tied to logic low OUT: Tied to logic high  13 and 14 = VID0 11 and 12 = VID1 9 and 10 = VID2 7 and 8 = VID3 5 and 6 = VID4 3 and 4 = VID5 1 and 2 = VID6
J2F3	Reserved	OUT Do not alter jumper setting	
J2G1	GFX VID Code Override	OUT	1-2: Activate Override For each VID signal IN: Tied to logic low OUT: Tied to logic high  3 and 4 = VID0 5 and 6 = VID1 7 and 8 = VID2 9 and 10 = VID3 11 and 12 = VID4 13 and 14 = VR_ENABLE 15 and 16 = No Function
J2H1	Force Shutdown	OUT: Normal Operation	IN: Force the board to shutdown
J2H2	Reserved	OUT Do not alter jumper setting	
J2H3	Reserved	OUT Do not alter jumper setting	
J2J1	Reserved	OUT Do not alter jumper setting	
J2J2	Reserved	OUT Do not alter jumper setting	
J2J3	Reserved	OUT Do not alter jumper setting	
J2J4	Reserved	OUT Do not alter jumper setting	
J2J5	Reserved	OUT Do not alter jumper setting	
J2J6	Reserved	OUT Do not alter jumper setting	
J3B2	Thermal Diode Connection	1-2 and 3-4: Normal operation	OUT: Disconnect CPU thermal diode from thermal sensor
J3G1	Power On Latch	OUT: Normal operation	IN: Latch the power on



Reference Designator	Function	Default Setting	Optional Setting
J3J1	Reserved	OUT Do not alter jumper setting	
J3J2	Reserved	OUT Do not alter jumper setting	
J3J3	Reserved	OUT Do not alter jumper setting	
J4H1	ME G3 to M1	OUT: Normal operation	IN: Jump power state from G3 to M1
J5H1	Reserved	OUT Do not alter jumper setting	
J5H2	Clear CMOS	OUT: Normal operation	IN: Clear CMOS
J6G1	Reserved	OUT Do not alter jumper setting	
J6H2	Reserved	IN Do not alter jumper setting	
J7D1	Super IO Reset	1-2: Normal operation	2-3: Hold Super IO in reset
J7J1	Reserved	OUT Do not alter jumper setting	
J7J2	SATA Power Enable	IN: (SATA Port-1) Hot Plug/Removal Supported (SATA Port -2) Device not connected through cable	OUT: (SATA Port-1) Hot Plug/Removal not Supported (SATA Port -2) Device connected through cable
J8B1	Remote H8 Programming	1-2: Normal operation	2-3: Program H8
J8B2	Remote H8 Programming	1-2: Normal operation	2-3: Program H8
J8E2	Boot BIOS Location	OUT: Normal operation. Boot through LPC (If R7U12 is NO STUFF)	IN: PCI or SPI (Depends on R7U12 stuffing)
J8F1	Reserved	OUT Do not alter jumper setting	
J8F2	BIOS Recovery	OUT: Normal operation	IN: BIOS recovery
J8G1	Reserved	OUT Do not alter jumper setting	
J9F1	H8 Reset	1-2: Normal operation	2-3: Hold H8 in reset
J9F2	LAN Enable	1-2: LAN Enable	2-3: LAN Disable
J9G2	Boot Block Programming	IN: Normal operation	OUT: Program H8
J9H1	Virtual Docking	OUT: Normal operation	IN: Virtual docking enabled
J9H2	1Hz clock and	OUT: Normal operation, clock	IN: Clock disabled, enable H8



Reference Designator	Function	Default Setting	Optional Setting
	H8 Programming NMI	enabled	programming
J9H3	KBC Disable	OUT: Normal operation, Keyboard Controller enabled	IN: Keyboard Controller disabled
J9H4	SMC MD0	IN: Normal operation. External programming allowed	OUT: No external programming
J9H5	SATA Device Detect	IN: SATA device present	OUT: SATA device not present
J9H6	SMC MD2	OUT: Normal operation	IN: Advanced single chip mode
J9H7	SMC MD1	IN: Normal operation. External programming allowed	OUT: No external programming
J9H8	Lid Position	OUT: Lid Open	IN: Lid Closed
J9H9	Virtual Battery	OUT: Normal operation	IN: Virtual battery mode
SW1C1	Power Button	N/A	N/A
SW1C2	Reset Button	N/A	N/A
SW8E1	Net Detect	N/A	N/A
SW9H1	Virtual Docking	1-2: Normal operation	2-3: Virtual docking enabled
SW9H2	Virtual Battery	1-2: Normal operation	2-3: Virtual battery mode
SW9J1	Lid Position	OUT: Lid Open	IN: Lid Closed

**Note:** A jumper consists of two or more pins mounted on the motherboard. When a jumper cap is placed over two pins, it is designated as IN. When there are more than two pins on the jumper, the pins to be shorted are indicated as 1-2 (to short pin 1 to pin 2), or 2-3 (to short pin 2 to pin 3). When no jumper cap is to be placed on the jumper, it is designated as OUT. When a switch is designated as 1-2 the switch slide is positioned such that pins 1 and 2 are shorted together.

## 4.4 Power On and Reset Buttons

The development board has two push buttons that implement POWER and RESET functionality. The POWER button releases power to the entire development board, causing the board to boot. The RESET button will force all systems to warm reset. The two buttons are located near the CPU close to the edge of the development board. The POWER button is located at SW1C1 and the RESET button is located at SW1C2.

**Note:** If the development board is powered from an external ATX power supply (not a power brick), the Power button may need to be pressed twice to turn on the system.

## 4.5 LEDs

The development board has a number of LEDs. These LEDs provide status for various functions on the development board. [Figure 8](#) indicates the location of the LEDs and [Table 16](#) describes their function.

Figure 8. LED Locations

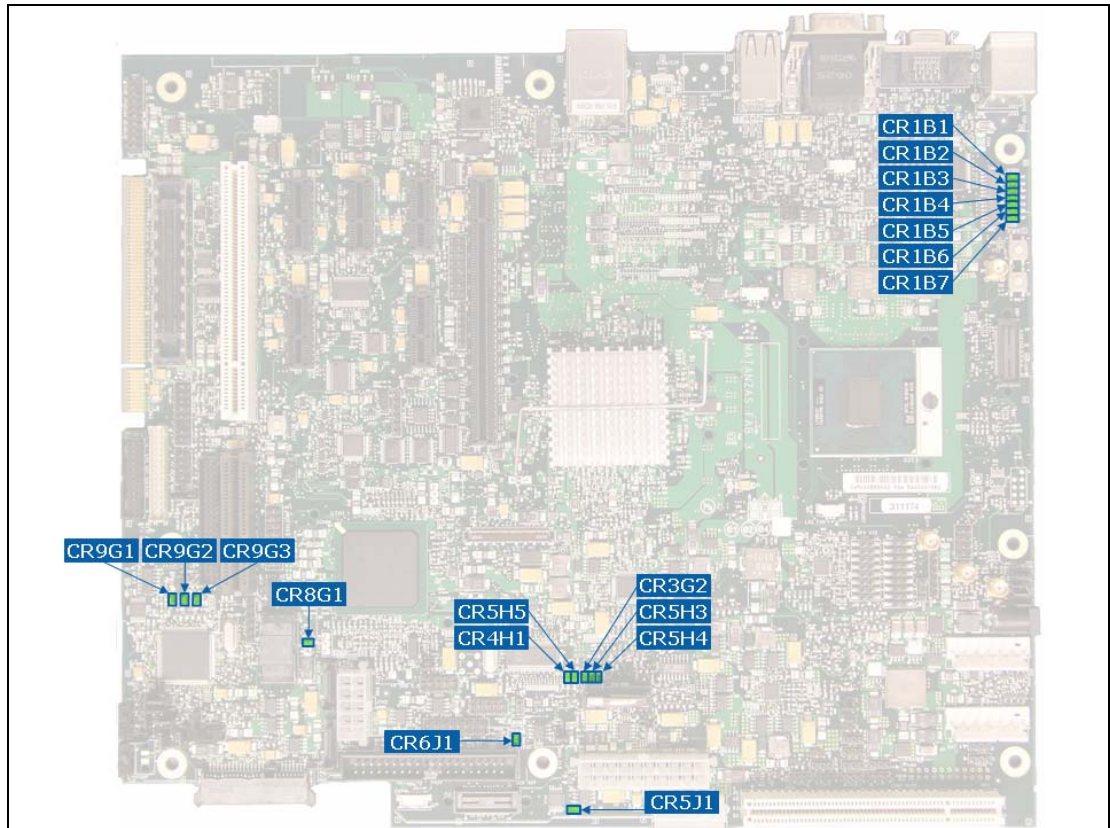

Table 16. LED Functions

Function	Reference Designator
Keyboard Number Lock	CR9G1
Keyboard Scroll Lock	CR9G2
Keyboard Caps Lock	CR9G3
System State S0	CR5H5
System State S3	CR3G2
System State S4	CR5H3
System State S5	CR5H4
ATA Activity	CR6J1



Function	Reference Designator
VID 0	CR1B1
VID 1	CR1B2
VID 2	CR1B3
VID 3	CR1B4
VID 4	CR1B5
VID 5	CR1B6
VID 6	CR1B7
M0/M1	CR4H1
System Power Good	CR5J1
Reserved	CR8G1

## 4.6 Other Headers, Slots and Sockets

### 4.6.1 H8 Programming Headers

The microcontroller firmware for system management/keyboard/mouse control can be upgraded in two ways. The user can either use a special DOS\* utility known as KSCFlash (in-circuit) or use an external computer connected (remote) to the system via the serial port on the development board. KSCFlash is available on request from your Intel representative.

If the user chooses to use an external computer connected to the system via the serial port, there are four jumpers that must be set correctly first. Please refer to [Table 15](#) for a summary of these jumpers and refer to [Figure 7](#) for the location of each jumper.

Required Hardware: one Null Modem Cable and a Host Unit with a serial COM port (System used to flash the development board)

Here is the sequence of events necessary to program the H8 via the serial port.

1. Extract all files (keep them in the same folder) to a single directory of your choice on the host machine or on a floppy disk.
2. Connect a NULL modem cable to the serial ports of each platform (host and unit to be flashed).
3. With the development board powered off, move the following jumpers to the programming stuffing option.
  - a. J9G2 (remove) (default: 1-2), Sets SMC\_INIT\_CLK high.
  - b. J8B1 (2-3) (default: 1-2), link the Host Unit to on-board H8.
  - c. J8B2 (2-3) (default: 1-2), link the Host Unit to on-board H8.



- d. J9H2 (1-2) (default: 1-X), disable 1 Hz Clock.
4. Attach an ATX power supply or AC to DC adapter to the system and power up the development board.
5. From the directory where you extracted the files, run the "kscflash ksc.bin / remote" command to program the H8 via the serial port.
6. Follow the instructions the flash utility provides.
7. With the development board powered off, return the jumpers to their default setting.

**Note:** Make sure the development board is not powered on, and the power supply is disconnected before moving any of the jumpers.

## 4.6.2 Expansion Slots and Sockets

Following is a list of the slots and sockets available for attaching additional devices. Refer to [Figure 2](#) for locations.

**Table 17. Expansion Slots and Sockets**

Reference Designator	Slot/Socket Description	Detail
U2E1	478 Pin Grid Array (Micro-FCPGA) Processor Socket	
J5P1	DDR2 - Channel 0 - SODIMM slot	
J5N1	DDR2 - Channel 1 - SODIMM slot	
J8F1	LVDS Graphics Interface	
J6B2	PCI Express* (x16)	<a href="#">Table 18</a>
J6B2	ADD2 Slot	<a href="#">Table 19</a>
J6B2	Media Expansion Card Slot	<a href="#">Table 20</a>
J8B4	PCI Express* (x1) Slot 3	<a href="#">Table 21</a>
J7B1	PCI Express* (x1) Slot 5	<a href="#">Table 21</a>
J6B1	PCI Express* (x1) Slot 1	<a href="#">Table 21</a>
J8B3	PCI 2.3 Slot 3	
J7J4	IDE Interface Connector	<a href="#">Table 22</a>
J8J1	SATA 'Direct Connect' Connector	<a href="#">Table 23</a>
J7J3, J7H1	SATA 'Cable Connect' Connector	<a href="#">Table 24</a>
J6H3	SATA Desk Top Power Connector	<a href="#">Table 25</a>
U8G1	Intel Firmware Hub Socket	
BT5H1	Battery	
J2B3, J2C1	Fan Connectors	<a href="#">Table 26</a>
J2F1	Fan Connector	<a href="#">Table 27</a>





Reference Designator	Slot/Socket Description	Detail
J6H5	Front Panel Header	<a href="#">Table 28</a>
J6H3, J6H4	USB Header	<a href="#">Table 29</a>

#### 4.6.2.1 478 Pin Grid Array (Micro-FCPGA) Socket

The pin locking mechanism on the CPU socket is released by rotating the screw on the socket 180 degrees counter-clockwise. CPU pins are keyed so as to only allow insertion in one orientation. DO NOT FORCE CPU into socket. Once the CPU is properly seated into the socket, turn the screw 180 degrees clock-wise to secure the CPU in the socket. Note that the slot on the screw aligns with the lock and unlock legend on the case of the CPU socket.

**Caution:** Please refer to the heatsink installation instructions in Appendix A prior to inserting the heatsink as the CPU and socket can be easily damaged.

**Caution:** Only insert Intel® Core™ 2 Duo Mobile processors that are intended for operation with the Mobile Intel® 965 Express Chipset Family into the development board. These processors have a pinout known as Socket-P. Earlier Intel® Core™ 2 Duo Mobile processors that have a pinout known as Socket-M are mechanically compatible with the processor socket but not electrically compatible. Insertion of these processors will cause damage to the processor and the development board.

#### 4.6.2.2 PCI Express\* (x16)

The development board has one x16 lane PCI Express\* Graphics slot and supports either x1, x2, x4, x8 or x16 modes. The slot is wired "lane reversed" which connects the Mobile Intel® GME965 Express Chipset lanes 0 through 15 to lanes 15 through 0 on the slot. The Mobile Intel® GME965 Express Chipset will internally un-reverse this wiring since its CFG9 power-on strap is tied low.

**Table 18. PCI Express\* (x16) Pinout (J6B2)**

Pin	Description	Pin	Description
A1	PRSNT1#	B1	+12V
A2	+12V	B2	+12V
A3	+12V	B3	+12V
A4	GND	B4	GND
A5	JTAG2 (TCK)	B5	SMCLK
A6	JTAG3 (TDI)	B6	SMDAT
A7	JTAG4 (TDO)	B7	GND
A8	JTAG5 (TMS)	B8	+3.3V
A9	+3.3V	B9	JTAG1 (TRST#)
A10	+3.3V	B10	+3.3VAUX



Pin	Description	Pin	Description
A11	PERST#	B11	WAKE#
Key			
A12	GND	B12	RSVD
A13	REFCLK+	B13	GND
A14	REFCLK-	B14	LANE 0 (T+)
A15	GND	B15	LANE 0 (T-)
A16	LANE 0 (R+)	B16	GND
A17	LANE 0 (R-)	B17	PRSNT2*
A18	GND	B18	GND
End of x1 Connector			
A19	RSVD	B19	LANE 1 (T+)
A20	GND	B20	LANE 1 (T-)
A21	LANE 1 (R+)	B21	GND
A22	LANE 1 (R-)	B22	GND
A23	GND	B23	LANE 2 (T+)
A24	GND	B24	LANE 2 (T-)
A25	LANE 2 (R+)	B25	GND
A26	LANE 2 (R-)	B26	GND
A27	GND	B27	LANE 3 (T+)
A28	GND	B28	LANE 3 (T-)
A29	LANE 3 (R+)	B29	GND
A30	LANE 3 (R-)	B30	RSVD
A31	GND	B31	PRSNT2#
A32	RSVD	B32	GND
End of x4 Connector			
A33	RSVD	B33	LANE 4 (T+)
A34	GND	B34	LANE 4 (T-)
A35	LANE 4 (R+)	B35	GND
A36	LANE 4 (R-)	B36	GND
A37	GND	B37	LANE 5 (T+)
A38	GND	B38	LANE 5 (T-)
A39	LANE 5 (R+)	B39	GND
A40	LANE 5 (R-)	B40	GND
A41	GND	B41	LANE 6 (T+)
A42	GND	B42	LANE 6 (T-)



Pin	Description	Pin	Description
A43	LANE 6 (R+)	B43	GND
A44	LANE 6 (R-)	B44	GND
A45	GND	B45	LANE 7 (T+)
A46	GND	B46	LANE 7 (T-)
A47	LANE 7 (R+)	B47	GND
A48	LANE 7 (R-)	B48	PRSNT#2
A49	GND	B49	GND
End of x8 Connector			
A50	RSVD	B50	LANE 8 (T+)
A51	GND	B51	LANE 8 (T-)
A52	LANE 8 (R+)	B52	GND
A53	LANE 8 (R-)	B53	GND
A54	GND	B54	LANE 9 (T+)
A55	GND	B55	LANE 9 (T-)
A56	LANE 9 (R+)	B56	GND
A57	LANE 9 (R-)	B57	GND
A58	GND	B58	LANE 10 (T+)
A59	GND	B59	LANE 10 (T-)
A60	LANE 10 (R+)	B60	GND
A61	LANE 10 (R-)	B61	GND
A62	GND	B62	LANE 11 (T+)
A63	GND	B63	LANE 11 (T-)
A64	LANE 11 (R+)	B64	GND
A65	LANE 11 (R-)	B65	GND
A66	GND	B66	LANE 12 (T+)
A67	GND	B67	LANE 12 (T-)
A68	LANE 12 (R+)	B68	GND
A69	LANE 12 (R-)	B69	GND
A70	GND	B70	LANE 13 (T+)
A71	GND	B71	LANE 13 (T-)
A72	LANE 13 (R+)	B72	GND
A73	LANE 13 (R-)	B73	GND
A74	GND	B74	LANE 14 (T+)
A75	GND	B75	LANE 14 (T-)
A76	LANE 14 (R+)	B76	GND



Pin	Description	Pin	Description
A77	LANE 14 (R-)	B77	GND
A78	GND	B78	LANE 15 (T+)
A79	GND	B79	LANE 15 (T-)
A80	LANE 15 (R+)	B80	GND
A81	LANE 15 (R-)	B81	PRST2#
A82	GND	B82	RSVD

### 4.6.2.3 ADD2/Media Expansion Card (MEC) Slot

When not being used for PCI Express\*, the x16 slot can be used for Serial Digital Video Out (SDVO). An ADD2N card can be inserted into the SDVO slot to enable the use of third party vendor transmitters to output video formats such as DVI, TV, LVDS and HDMI. [Table 19](#) describes the ADD2N interface pin-out.

The SDVO interface will also support a Media Expansion Card (MEC), which provide TV Capture over the PCI Express\* x1 port in addition to the standard ADD2 card video out capabilities. [Table 20](#) describes the MEC interface pin-out.

**Table 19. ADD2 Slot (J6B2)**

Pin	Description	Pin	Description
A1	N/C	B1	12 V
A2	12 V	B2	12 V
A3	12 V	B3	Reserved
A4	GND	B4	GND
A5	N/C	B5	N/C
A6	TDI	B6	N/C
A7	TDO	B7	GND
A8	N/C	B8	3.3 V
A9	3.3 V	B9	N/C
A10	3.3 V	B10	N/C
A11	RESET	B11	N/C
Key			
A12	GND	B12	Reserved
A13	N/C	B13	GND
A14	N/C	B14	SDVOB_Red+
A15	GND	B15	SDVOB_Red-
A16	SDVO_TVClkIn+	B16	GND
A17	SDVO_TVClkIn-	B17	SDVO_CtrClk



Pin	Description	Pin	Description
A18	GND	B18	GND
End of x1 Connector			
A19	Reserved	B19	SDVO_Green+
A20	GND	B20	SDVO_Green-
A21	SDVOB_Int+	B21	GND
A22	SDVOB_Int-	B22	GND
A23	GND	B23	SDVOB_Blue+
A24	GND	B24	SDVOB_Blue-
A25	SDVO_Stall+	B25	GND
A26	SDVO_Stall-	B26	GND
A27	GND	B27	SDVOB_Clk+
A28	GND	B28	SDVOB_Clk-
A29	N/C	B29	GND
A30	N/C	B30	Reserved
A31	GND	B31	SDVO_CtrlData
A32	Reserved	B32	GND
End of x4 Connector			
A33	Reserved	B33	SDVOC_Red+
A34	GND	B34	SDVOC_Red-
A35	N/C	B35	GND
A36	N/C	B36	GND
A37	GND	B37	SDVOC_Green+
A38	GND	B38	SDVOC_Green-
A39	SDVOC_Int+	B39	GND
A40	SDVOC_Int-	B40	GND
A41	GND	B41	SDVOC_Blue+
A42	GND	B42	SDVOC_Blue-
A43	N/C	B43	GND
A44	N/C	B44	GND
A45	GND	B45	SDVOC_Clk+
A46	GND	B46	SDVOC_Clk-
A47	N/C	B47	GND
A48	N/C	B48	N/C
A49	GND	B49	GND
End of x8 Connector			



Pin	Description	Pin	Description
A50	Reserved	B50	N/C
A51	GND	B51	N/C
A52	N/C	B52	GND
A53	N/C	B53	GND
A54	GND	B54	N/C
A55	GND	B55	N/C
A56	N/C	B56	GND
A57	N/C	B57	GND
A58	GND	B58	N/C
A59	GND	B59	N/C
A60	N/C	B60	GND
A61	N/C	B61	GND
A62	GND	B62	N/C
A63	GND	B63	N/C
A64	N/C	B64	GND
A65	N/C	B65	GND
A66	GND	B66	N/C
A67	GND	B67	N/C
A68	N/C	B68	GND
A69	N/C	B69	GND
A70	GND	B70	N/C
A71	GND	B71	N/C
A72	N/C	B72	GND
A73	N/C	B73	GND
A74	GND	B74	N/C
A75	GND	B75	N/C
A76	N/C	B76	GND
A77	N/C	B77	GND
A78	GND	B78	N/C
A79	GND	B79	N/C
A80	N/C	B80	GND
A81	N/C	B81	N/C
A82	GND	B82	Reserved



Table 20. MEC Slot (J6B2)

Pin	Description	Pin	Description
A1	N/C	B1	12 V
A2	12 V	B2	12 V
A3	12 V	B3	Reserved
A4	GND	B4	GND
A5	N/C	B5	N/C
A6	N/C	B6	N/C
A7	N/C	B7	GND
A8	N/C	B8	3.3 V
A9	3.3 V	B9	N/C
A10	3.3 V	B10	+3.3VA
A11	RESET	B11	WAKE#
Key			
A12	GND	B12	Reserved
A13	REFCLK+	B13	GND
A14	REFCLK-	B14	Lane 0 (T+)
A15	GND	B15	Lane 0 (T-)
A16	Lane 0 (R+)	B16	GND
A17	Lane 0 (R-)	B17	SDVO_CtrlClk
A18	GND	B18	GND
End of x1 Connector			
A19	Reserved	B19	N/C
A20	GND	B20	N/C
A21	N/C	B21	GND
A22	N/C	B22	GND
A23	GND	B23	N/C
A24	GND	B24	N/C
A25	N/C	B25	GND
A26	N/C	B26	GND
A27	GND	B27	N/C
A28	GND	B28	N/C
A29	N/C	B29	GND
A30	N/C	B30	Reserved
A31	GND	B31	SDVOB_CtrlData
A32	Reserved	B32	GND



Pin	Description	Pin	Description
End of x4 Connector			
A33	Reserved	B33	N/C
A34	GND	B34	N/C
A35	N/C	B35	GND
A36	N/C	B36	GND
A37	GND	B37	N/C
A38	GND	B38	N/C
A39	N/C	B39	GND
A40	N/C	B40	GND
A41	GND	B41	N/C
A42	GND	B42	N/C
A43	N/C	B43	GND
A44	N/C	B44	GND
A45	GND	B45	N/C
A46	GND	B46	N/C
A47	N/C	B47	GND
A48	N/C	B48	MEC_Enable
A49	GND	B49	GND
End of x8 Connector			
A50	Reserved	B50	SDVOC_CLK+
A51	GND	B51	SDVOC_CLK-
A52	N/C	B52	GND
A53	N/C	B53	GND
A54	GND	B54	SDVOC_Blue+
A55	GND	B55	SDVOC_Blue-
A56	N/C	B56	GND
A57	N/C	B57	GND
A58	GND	B58	SDVOC_Green+
A59	GND	B59	SDVOC_Green-
A60	SDVOC_Int+	B60	GND
A61	SDVOC_Int-	B61	GND
A62	GND	B62	SDVOC_Red+
A63	GND	B63	SDVOC_Red-
A64	N/C	B64	GND
A65	N/C	B65	GND





Pin	Description	Pin	Description
A66	GND	B66	SDVOB_Clk+
A67	GND	B67	SDVOB_Clk-
A68	N/C	B68	GND
A69	N/C	B69	GND
A70	GND	B70	SDVOB_Blue+
A71	GND	B71	SDVOB_Blue-
A72	SDVO_Stall+	B72	GND
A73	SDVO_Stall-	B73	GND
A74	GND	B74	SDVOB_Green+
A75	GND	B75	SDVOB_Green-
A76	SDVOB_Int+	B76	GND
A77	SDVOB_Int-	B77	GND
A78	GND	B78	SDVOB_Red+
A79	GND	B79	SDVOB_Red-
A80	SDVO_TVClkIn+	B80	GND
A81	SDVO_TVClkIn-	B81	N/C
A82	GND	B82	Reserved

#### 4.6.2.4 PCI Express\* (x1)

The three PCI Express\* x1 connectors allow the use of any industry standard PCI Express\* device. The pin configuration of the connectors is given below.

**Table 21. PCI Express\* (x1) Pinout (J6B1, J7B1, J8B4)**

Pin	Description	Pin	Description
A1	PRSNT1#	B1	+12V
A2	+12V	B2	+12V
A3	+12V	B3	+12V
A4	GND	B4	GND
A5	JTAG2 (TCK)	B5	SMCLK
A6	JTAG3 (TDI)	B6	SMDAT
A7	JTAG4 (TDO)	B7	GND
A8	JTAG5 (TMS)	B8	+3.3V
A9	+3.3V	B9	JTAG1 (TRST#)
A10	+3.3V	B10	+3.3VAUX
A11	PERST#	B11	WAKE#



Pin	Description	Pin	Description
Key			
A12	GND	B12	RSVD
A13	REFCLK+	B13	GND
A14	REFCLK-	B14	LANE 0 (T+)
A15	GND	B15	LANE 0 (T-)
A16	LANE 0 (R+)	B16	GND
A17	LANE 0 (R-)	B17	PRSNT2*
A18	GND	B18	GND

#### 4.6.2.5 IDE Connector

The IDE interface can support up to two devices, a master and a slave. Ensure that the jumpers on the devices are properly selected for the given configuration. Mobile devices with an IDE interface will require an adapter to connect to this port.

Table 22. IDE Connector

Pin	Signal	Pin	Signal
1	Reset	2	Ground
3	Data 7	4	Data 8
5	Data 6	6	Data 9
7	Data 5	8	Data 10
9	Data 4	10	Data 11
11	Data 3	12	Data 12
13	Data 2	14	Data 13
15	Data 1	16	Data 14
17	Data 0	18	Data 15
19	Ground	20	Key
21	DDRQ	22	Ground
23	I/O Write	24	Ground
25	I/O Read	26	Ground
27	I/O HRDY	28	Cable Select
29	DDACK	30	Ground
31	IRQ	32	No Connect
33	Address 1	34	DMA66_Detect
35	Address 0	36	Address 2
37	Chip Select 1	38	Chip Select 3
39	Activity	40	Ground



#### 4.6.2.6 SATA Pinout

Up to three SATA devices may be supported by the SATA connectors on the development board. [Table 23](#) describes the SATA 'Direct Connect' connector and [Table 24](#) describes the SATA 'Cable Connect' connectors.

**Table 23. SATA Port 0 'Direct Connect' Connector Pinout (J8J1)**

Pin	Signal
2	TX
3	TX#
5	RX#
6	RX
8, 9, 10	+3.3V
14, 15, 16	+5V
20, 21, 22	+12V
1, 4, 7, 11	GND
12, 13, 17, 19	GND

**Table 24. SATA Ports 1 and 2 'Cable Connect' Connector Pinout (J7J3, J7H1)**

Pin	Signal
2	TX
3	TX#
5	RX#
6	RX
1, 4, 7	GND

**Table 25. SATA Power Connection (J7H2)**

Pin	Signal
1, 3	+3.3V
3, 4	+5V
5	+12V
6, 7, 8, 9, 10	GND

#### 4.6.2.7 Fan Connectors

The development board implements three fan connectors. The connectors at J2B3 and J2C1 have a speed controlled power supply. The connector at J2F1 has a fixed power supply.



Connector J2B3 is used to power the CPU fan. Connectors J2C1 and J2F1 are not used in the default operation of the development board.

**Table 26. Fan Connectors (J2B3, J2C1)**

Pin	Signal
1	+V
2	TACH
3	GND

**Table 27. Fan Connector (J2F1)**

Pin	Signal
1	+5V
2	NC
3	GND

#### 4.6.2.8 Front Panel Header (J6H5)

The front panel header allows connection of the LEDs and switches typically found in an ATX chassis to the development board.

**Table 28. Front Panel Connector**

Pin	Signal	Definition
1	FRONT1	5 volt front panel LED supply
2	FRONT2	5 volt front panel LED supply
3	ATA_LED#	Indicates PATA or SATA activity – Active Low
4	GND	Ground
5	GND	Ground
6	PWR_CONN_D	System Power – Active Low
7	RST_PUSH#_D	System Reset – Active Low
8	GND	Ground
9	+V5	5 volt supply
10	N/C	No Connect
11	N/C	No Connect
12	GND	Ground
13	GND	Ground
14	N/C	No Connect
15	Reserved	



16	+V5	5 volt supply
----	-----	---------------

#### 4.6.2.9 USB Headers (J6H3, J6H4)

The USB headers implement 4 additional USB ports on the development board. Connector J6H3 implements ports 7 and 8 and connector J6H4 implements ports 2 and 4.

**Table 29. USB Headers**

Pin	Signal	Definition
1	+V5A_L_USBPWR	5 volt – Always On
2	+V5A_L_USBPWR	5 volt – Always On
3	USB_PNx	Data- (USB Port x)
4	USB_PNy	Data- (USB Port y)
5	USB_PPx	Data+ (USB Port x)
6	USB_PPy	Data+ (USB Port y)
7	GND	Ground
8	GND	Ground
9	N/C	No Connect
10	N/C	No Connect

## Appendix A. Heatsink Installation Instructions

---

It is necessary for the Intel® Core™ 2 Duo processor to have a thermal solution attached to it in order to keep it within its operating temperature.

**Caution:** An ESD wrist strap must be used when handling the board and installing the heatsink/fan assembly.

A heatsink is included in the kit. To install the heatsink:

1. Remove the heatsink from its package and separate the fan heatsink portion from the heatsink backplate.

Figure 9. Heatsink and Backplate

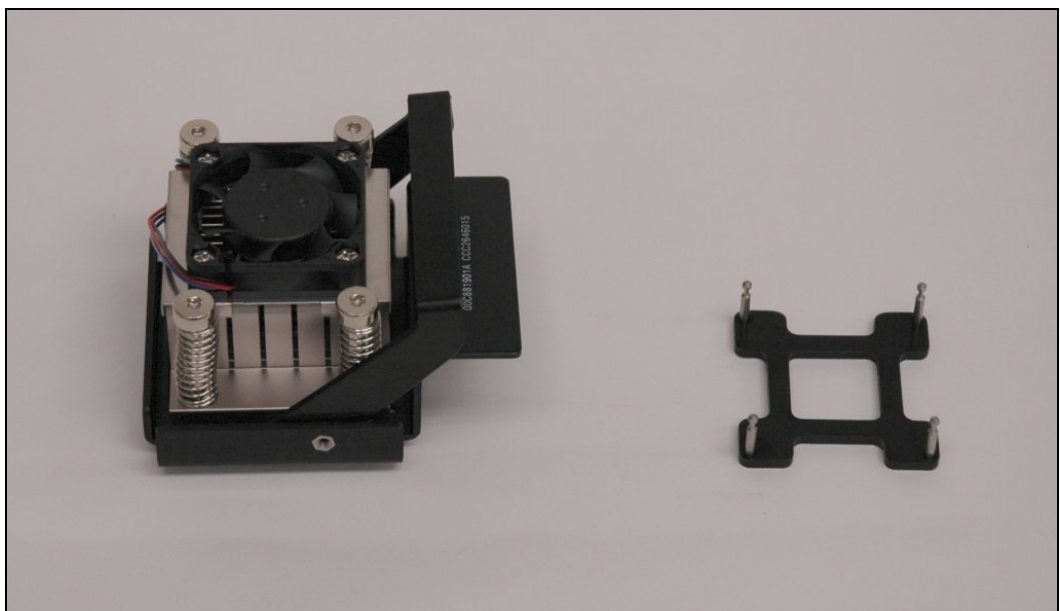

2. Examine the base of the heatsink, where contact with the processor die is made. This surface should be clean of all materials and greases. Wipe the bottom surface clean with isopropyl alcohol.
3. Place the backplate on the underside of the development board so that the pins protrude through the holes in the development board around the processor.

Figure 10. Backplate Pins

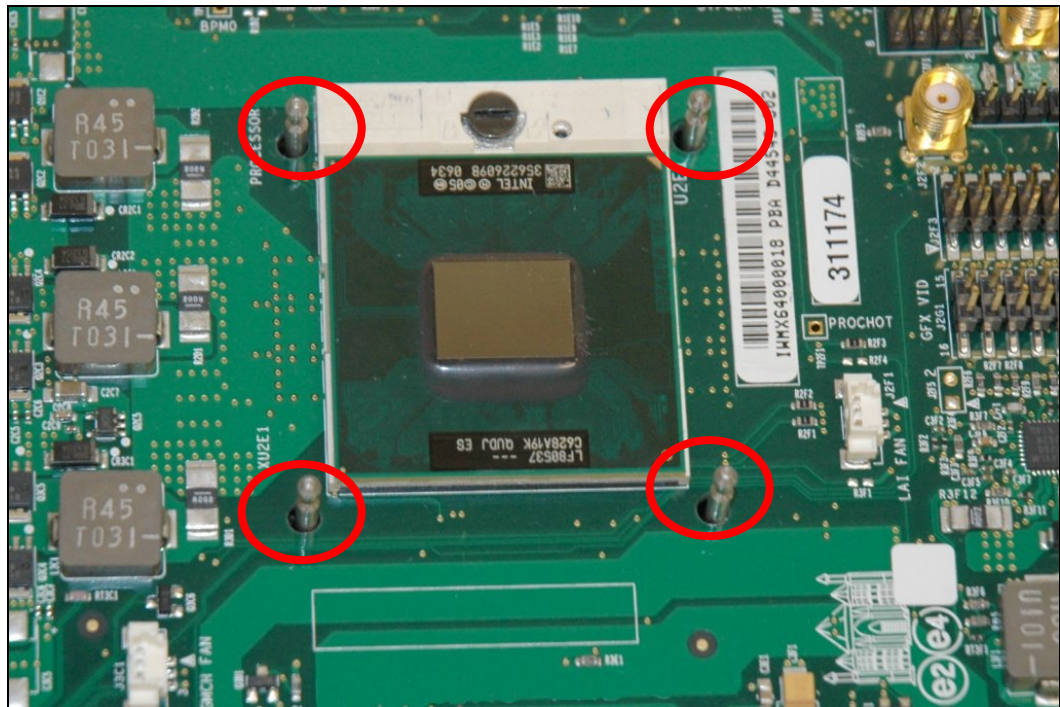

4. Clean the die of the processor with isopropyl alcohol before the heatsink is attached to the processor. This ensures that the surface of the die is clean.
5. Remove the tube of thermal grease from the package and use it to coat the exposed die of the CPU with the thermal grease.

Figure 11. Applying the Thermal Grease

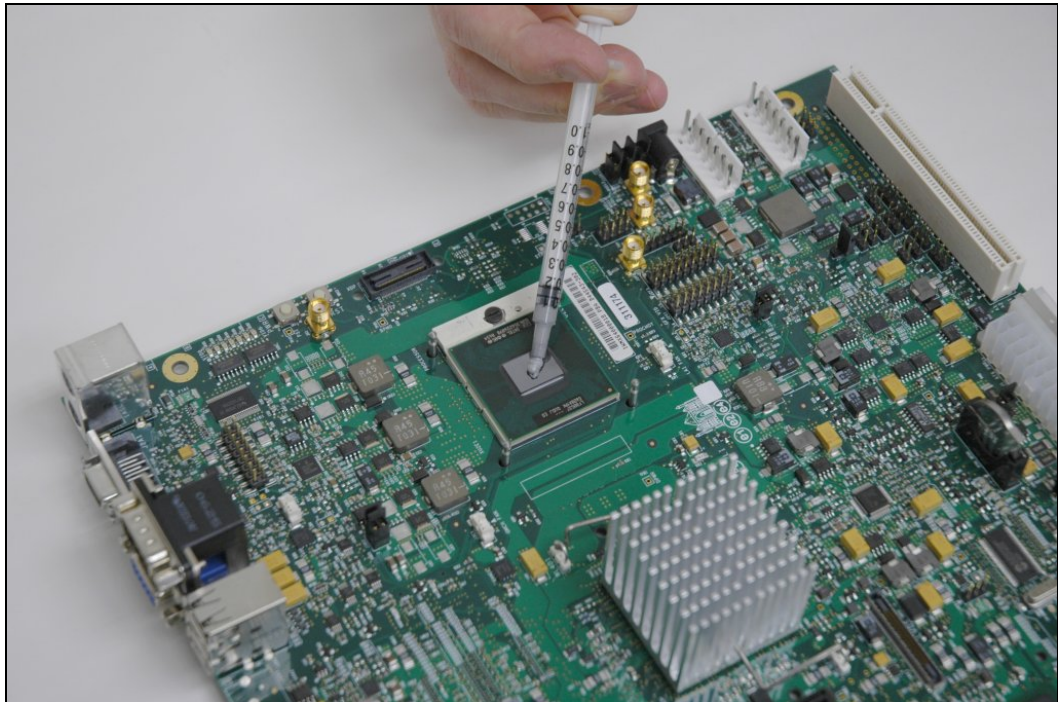

6. Pick up the heatsink and squeeze the activation arm until it comes in contact with the base plate that is attached to the heatsink base. This will cause the springs on the heatsink attachment mechanism to compress.

Figure 12. Squeezing Activation Arm

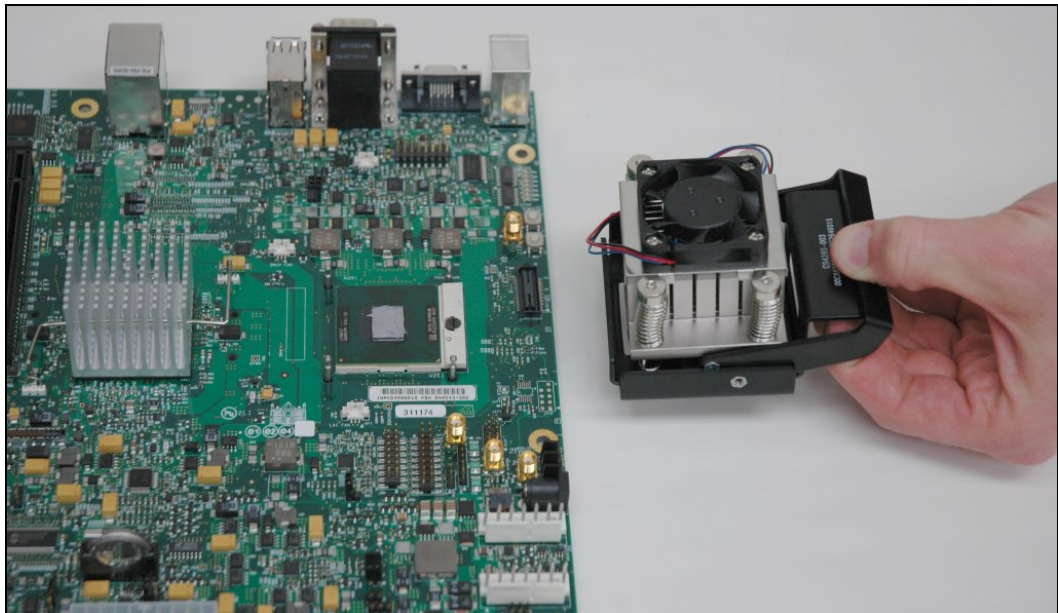





7. While keeping the activation arm compressed, place the heatsink over the pins of the heatsink backplate. Lower the heatsink until the lugs have inserted into the base of the heatsink. Slide the heatsink over the lugs on the backplate pins so that the base is directly over the processor die and the pins on the backplate have travelled the entire length of the channel in the heatsink base. Slowly let go of the activation arm until the base of the heatsink makes contact with the processor die. The heatsink base should be flat on top of the processor die.

**Figure 13. Installing the Heatsink**

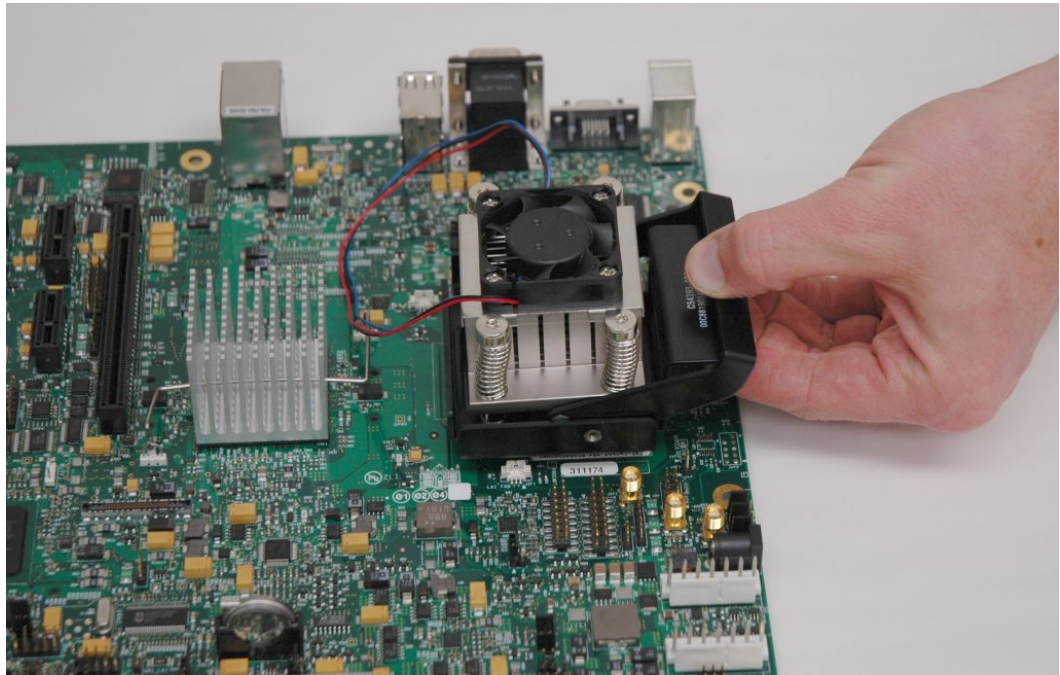

8. Plug the fan connector for the heatsink onto the CPU fan header (J2B3) on the motherboard.

**Note:** The CPU fan header (J2B3) is a 3-pin connector. This is a change from the Mobile Intel® 945GM Express Chipset Development Kit which has a 2-pin CPU fan header. As a result, it is not possible to use the heatsink from the Intel® 945GM Express Chipset Development Kit even though the heatsink and backplate are mechanically compatible.

Figure 14. Plugging in the Fan

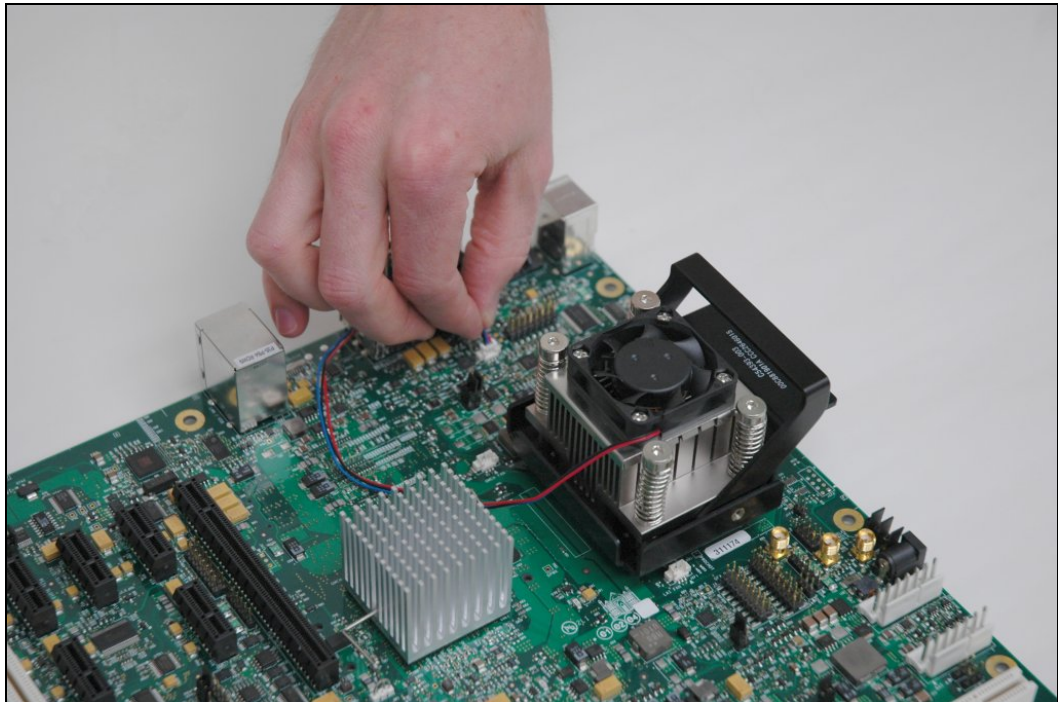

Figure 15. Completed Assembly

