

Research on Flexible radios

Dr. Krishnamurthy Soumyanath

Intel Fellow

Director, Communications Circuits Lab

Tomorrow's needs

← *Today* ————— *2008-10* ————— *2010+* →



"Discrete" Radios

One/multi standard
Bulky, costly
Inflexible

Integrated Radios

Full RF/BB/MAC Integration
Multi-standard
WiFi, WiMAX, BT, GPA and
MDTV..?

Cognitive Radios

Reconfigurable CMOS Radios
Multiple antenna systems
Spectrum Reuse

Single chip, multi standard, cognitive transceivers

What is the RF design and platform environment ?

- Analog and RF scale poorly (Max 10-15% per generation)
- Multi-standard RF requirements complicate scaling issue
- Shrinking platform dimensions predicate single chip solutions to meet form factor considerations

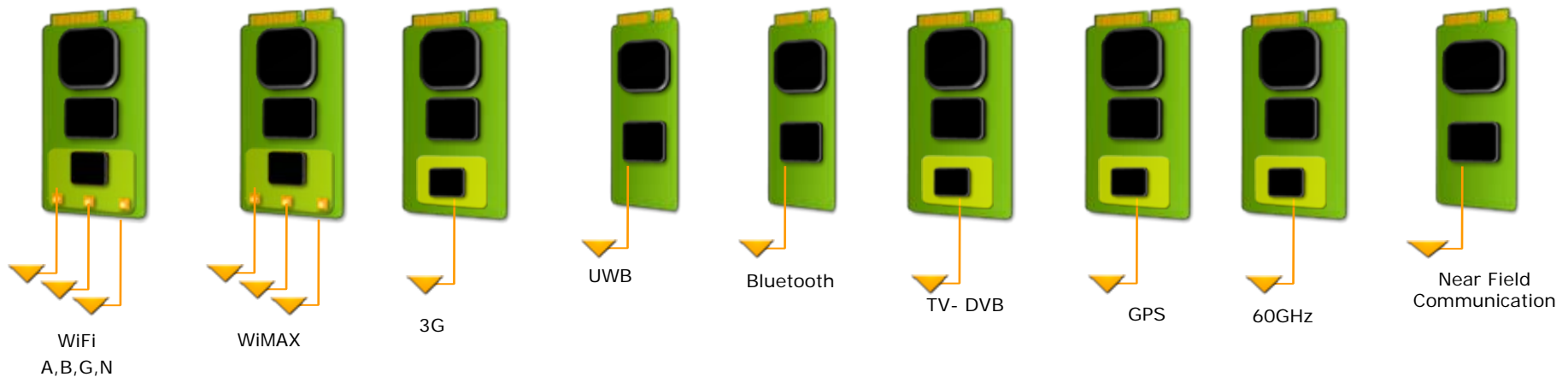

Poor analog and RF scaling do not prevent single chip integration but make it economically non viable. Digital cannot "wait" for analog die size reduction

What are the requirements for digital Baseband/MAC ?

- Scale as fast as technology will allow. Process cost is not a show stopper
- Multi-standard die size needs to be small to make business sense
- Driven by the requirements of large BB/Macs for 3G/LTE and WiMAX
- Digital could use 45nm technology today

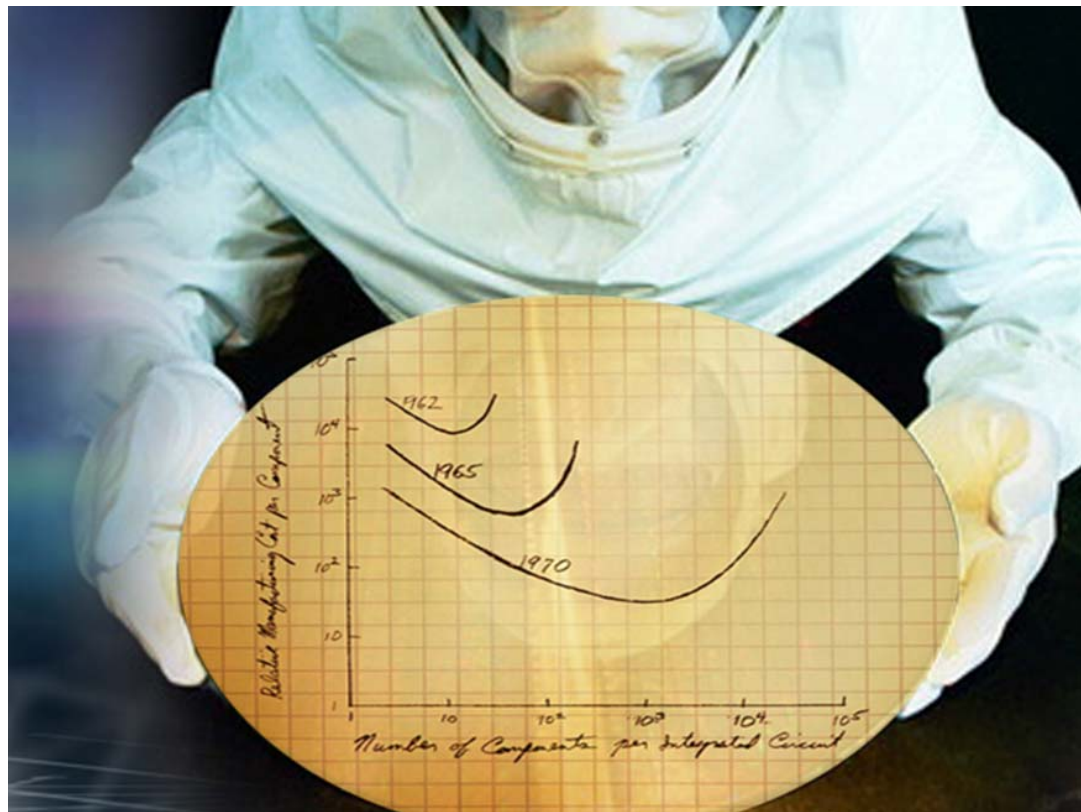

Current RF/analog trend is in profound conflict with market needs

Digitally Enhanced Radio (DER)

Goals:

Replace analog processing with digital signal processing

Digital calibration & compensation to correct for analog impairments

Reduce die size and power

Benefits:

Improve scalability & time to market

Reduce design cycles and design reuse

Single-chip integration

Increase flexibility for multi-protocol radios

Design digital process for ease of integration

22 inductors per radio

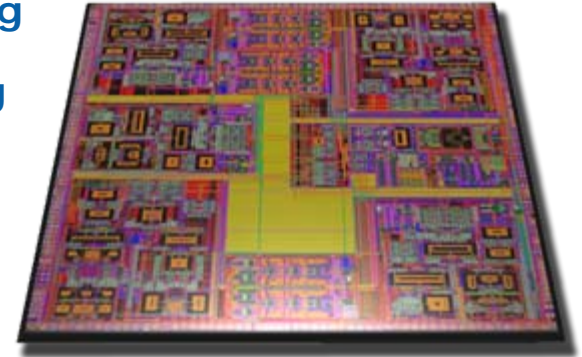

<3
inductors
per radio

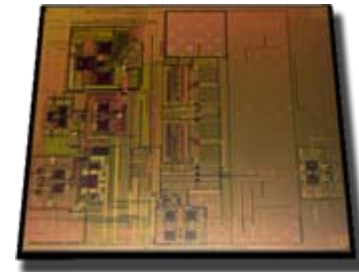

The future: System on a Chip

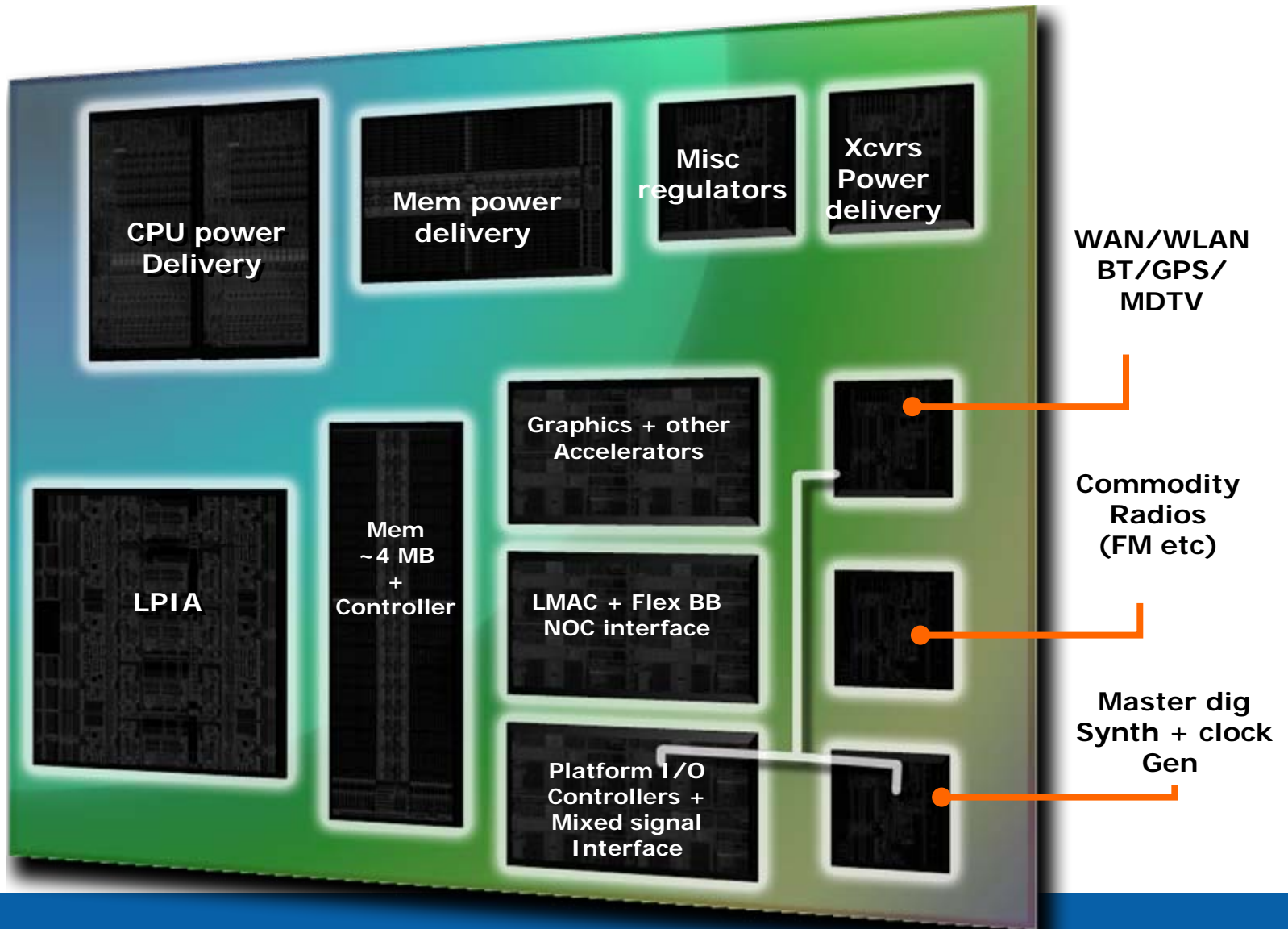

Conclusion

- Intel is enabling the multi radio platform of the future with research on end to end flexibility: from antenna to bits.
- Digitally enhanced radio (DER) enables:
 - Next generation of cognitive radios
 - Increased flexibility for multi radio platforms
 - Cost reduction with leading edge CMOS process (45 nm and beyond)
- Flexible FEM research complements DER and enables cost reduction
- Flexible antenna research reduces form factor and provides more options for placement

Back up

Digital RF to the rescue(?)

- **What is it?**

- Replace analog processing with digital signal processing wherever possible
- Use digital calibration techniques to correct for analog impairments where replacement is not possible

- **Examples**

- Replace pipelined converter with high DR sigma delta → reduced analog filtering
- Use digital calibration to correct for RF front end impairments → lowered linearity requirements → reduced inductor count
- Use high speed modulators to replace analog filtering and mixing in Tx chain → reduced inductor count
- Use sigma delta techniques to remove need for analog loop filter in synthesizer → reduced capacitor area

- **What it is not**

- Sampling analog signals on capacitors and doing analog switched cap processing

Reduce die size, improve scalability and increase flexibility

Traditional Analog Rx

Traditional approach relies heavily on analog blocks

- Sensitive to analog imprecision
- Large footprint
- External elements

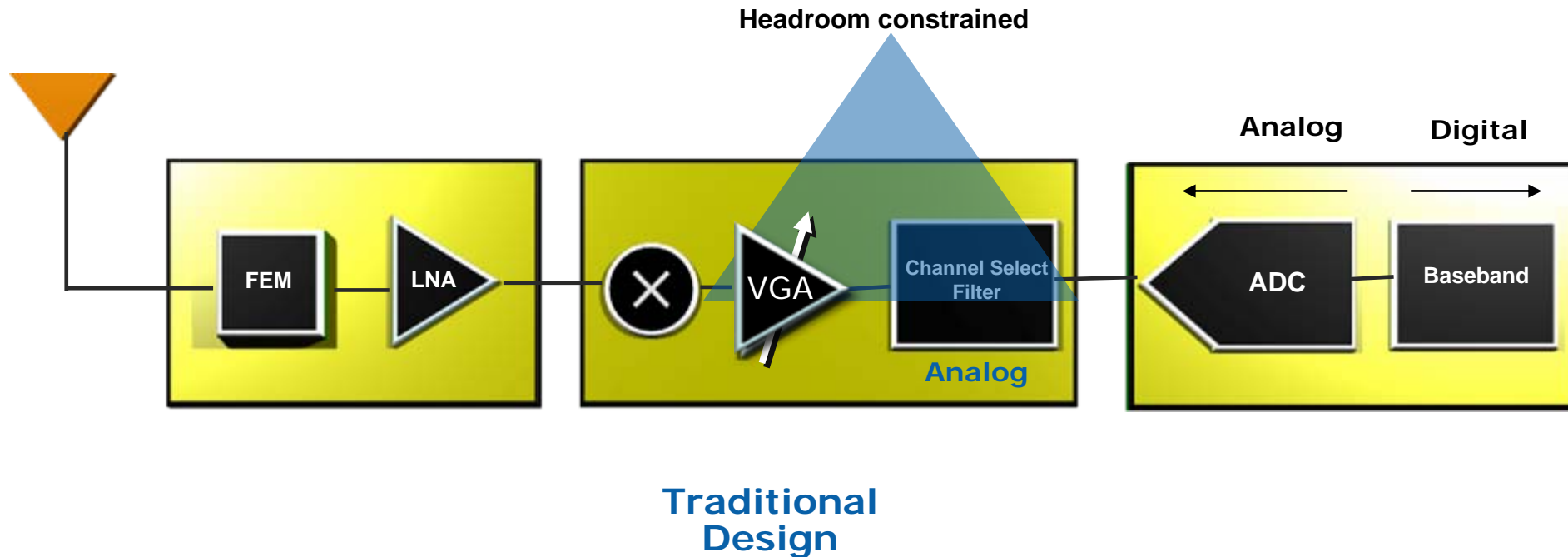

Digitally Enhanced Rx

Blur the line between digital and analog

- High speed Sigma Delta ADC operating at low supply voltage with channel selection done in digital baseband (11 bits vs. 9 bits conventional) without power penalty
- Natural evolution to a flexible radio
- Removes baseband analog signal processing

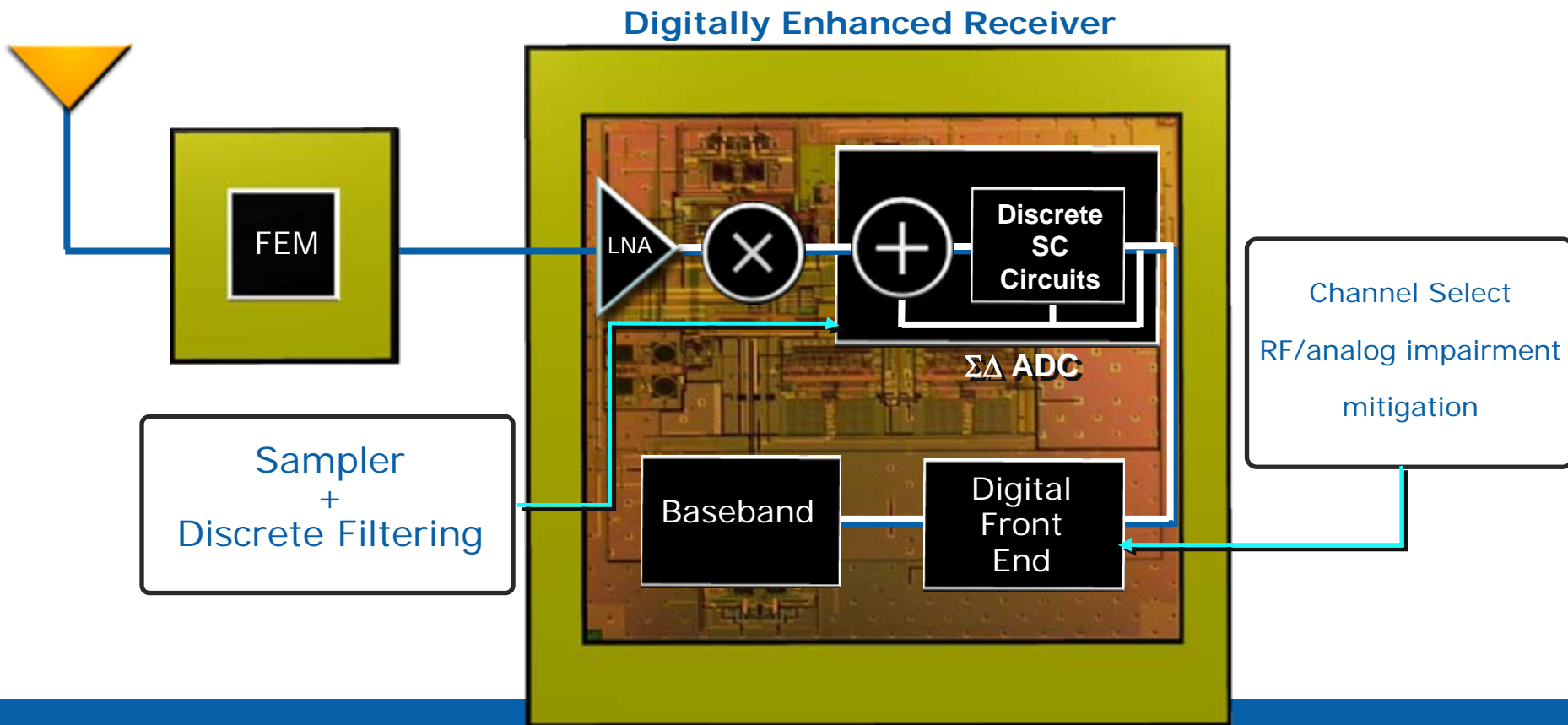

Traditional Analog Tx

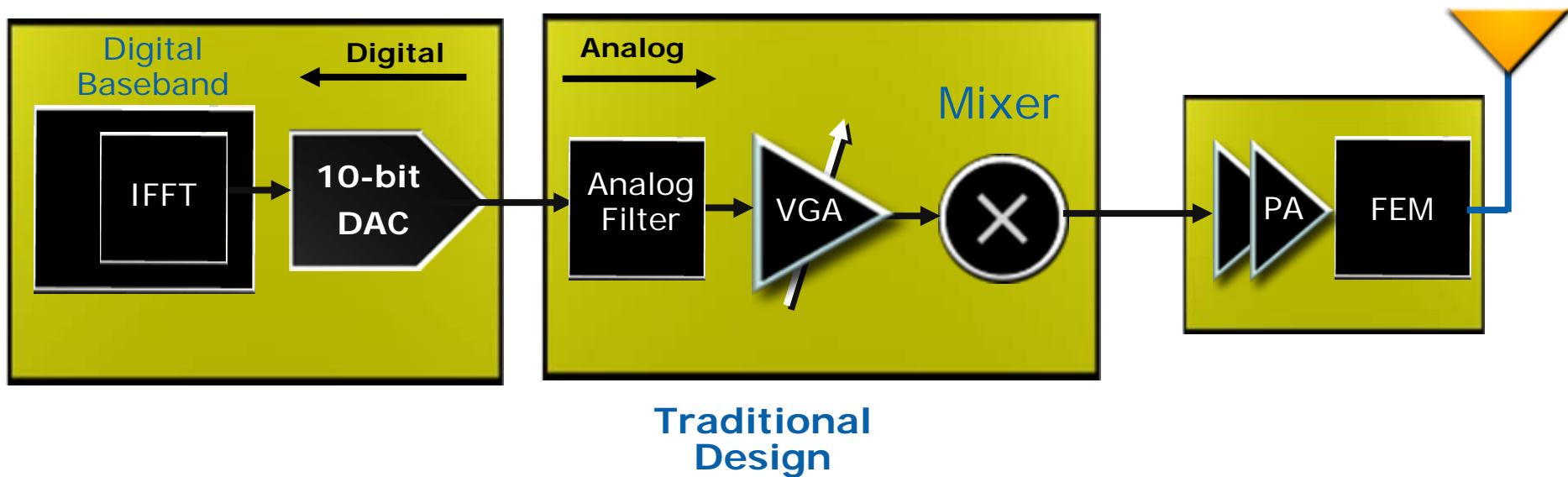

Digitally Enhanced Tx

RF synthesis approach and switching mode PA increases power efficiency

All digital chain up to final PA for flexibility, size and performance

Digital power control for WiMAX

Eliminates most inductors.

Digitally Enhanced Tx

