

Intel[®] Server Board S3000AH User's Guide

**A Guide for Technically Qualified Assemblers of Intel[®] Identified Subassemblies/
Products**

Intel Order Number D56209-003

Disclaimer

Information in this document is provided in connection with Intel® products. No license, express or implied, by estoppel or otherwise, to any intellectual property rights is granted by this document. Except as provided in Intel's Terms and Conditions of Sale for such products, Intel assumes no liability whatsoever, and Intel disclaims any express or implied warranty, relating to sale and/or use of Intel products including liability or warranties relating to fitness for a particular purpose, merchantability, or infringement of any patent, copyright or other intellectual property right. Intel products are not designed, intended or authorized for use in any medical, life saving, or life sustaining applications or for any other application in which the failure of the Intel product could create a situation where personal injury or death may occur. Intel may make changes to specifications and product descriptions at any time, without notice.

Intel server boards contain a number of high-density VLSI and power delivery components that need adequate airflow for cooling. Intel's own chassis are designed and tested to meet the intended thermal requirements of these components when the fully integrated system is used together. It is the responsibility of the system integrator that chooses not to use Intel developed server building blocks to consult vendor datasheets and operating parameters to determine the amount of airflow required for their specific application and environmental conditions. Intel Corporation can not be held responsible if components fail or the server board does not operate correctly when used outside any of their published operating or non-operating limits.

Intel, Intel Pentium, and Intel Xeon are trademarks or registered trademarks of Intel Corporation or its subsidiaries in the United States and other countries.

* Other names and brands may be claimed as the property of others.

Copyright © 2006, Intel Corporation. All Rights Reserved

Safety Information

Important Safety Instructions

Read all caution and safety statements in this document before performing any of the instructions. See also Intel Server Boards and Server Chassis Safety Information on the *Intel® Server Deployment Toolkit 2.0 CD* and/or at <http://support.intel.com/support/motherboards/server/sb/cs-010770.htm>.

Wichtige Sicherheitshinweise

Lesen Sie zunächst sämtliche Warnung und Sicherheitshinweise in diesem Dokument, bevor Sie eine der Anweisungen ausführen. Beachten Sie hierzu auch die Sicherheitshinweise zu Intel-Serverplatinen und Servergehäusen auf der *Intel® Server Deployment Toolkit 2.0 CD* oder unter <http://support.intel.com/support/motherboards/server/sb/cs-010770.htm>.

Consignes de sécurité

Lisez attention toutes les consignes de sécurité et les mises en garde indiquées dans ce document avant de suivre toute instruction. Consultez Intel Server Boards and Server Chassis Safety Information sur le *Intel® Server Deployment Toolkit 2.0 CD* ou bien rendez-vous sur le site <http://support.intel.com/support/motherboards/server/sb/cs-010770.htm>.

Instrucciones de seguridad importantes

Lea todas las declaraciones de seguridad y precaución de este documento antes de realizar cualquiera de las instrucciones. Vea Intel Server Boards and Server Chassis Safety Information en el *Intel® Server Deployment Toolkit 2.0 CD* y/o en <http://support.intel.com/support/motherboards/server/sb/cs-010770.htm>.

重要安全指导

在执行任何指令之前，请阅读本文档中的所有注意事项及安全声明。和/或 <http://support.intel.com/support/motherboards/server/sb/CS-010770.htm> 上的 *Intel Server Boards and Server Chassis Safety Information* (《Intel 服务器主板与服务器机箱安全信息》)。

Warnings

Heed safety instructions: Before working with your server product, whether you are using this guide or any other resource as a reference, pay close attention to the safety instructions. You must adhere to the assembly instructions in this guide to ensure and maintain compliance with existing product certifications and approvals. Use only the described, regulated components specified in this guide. Use of other products / components will void the UL listing and other regulatory approvals of the product and will most likely result in noncompliance with product regulations in the region(s) in which the product is sold.

System power on/off: The power button DOES NOT turn off the system AC power. To remove power from system, you must unplug the AC power cord from the wall outlet. Make sure the AC power cord is unplugged before you open the chassis, add, or remove any components.

Hazardous conditions, devices and cables: Hazardous electrical conditions may be present on power, telephone, and communication cables. Turn off the server and disconnect the power cord, telecommunications systems, networks, and modems attached to the server before opening it. Otherwise, personal injury or equipment damage can result.

Electrostatic discharge (ESD) and ESD protection: ESD can damage disk drives, boards, and other parts. We recommend that you perform all procedures in this chapter only at an ESD workstation. If one is not available, provide some ESD protection by wearing an antistatic wrist strap attached to chassis ground any unpainted metal surface on your server when handling parts.

ESD and handling boards: Always handle boards carefully. They can be extremely sensitive to ESD. Hold boards only by their edges. After removing a board from its protective wrapper or from the server, place the board component side up on a grounded, static free surface. Use a conductive foam pad if available but not the board wrapper. Do not slide board over any surface.

Installing or removing jumpers: A jumper is a small plastic encased conductor that slips over two jumper pins. Some jumpers have a small tab on top that you can grip with your fingertips or with a pair of fine needle nosed pliers. If your jumpers do not have such a tab, take care when using needle nosed pliers to remove or install a jumper; grip the narrow sides of the jumper with the pliers, never the wide sides. Gripping the wide sides can damage the contacts inside the jumper, causing intermittent problems with the function controlled by that jumper. Take care to grip with, but not squeeze, the pliers or other tool you use to remove a jumper, or you may bend or break the pins on the board.

Preface

About this Manual

Thank you for purchasing and using the Intel® Server Board S3000AH.

This manual is written for system technicians who are responsible for troubleshooting, upgrading, and repairing this server board. This document provides a brief overview of the features of the board/chassis, a list of accessories or other components you may need, troubleshooting information, and instructions on how to add and replace components on the Title of document. For the latest version of this manual, see <http://support.intel.com/support/motherboards/server/S3000AH/>.

Manual Organization

Chapter 1 provides a brief overview of the Intel® Server Board S3000AH. In this chapter, you will find a list of the server board features, photos of the product, and product diagrams to help you identify components and their locations.

Chapter 2 provides instructions on using the utilities that are shipped with the board or that may be required to update the system. This includes how to navigate through the BIOS Setup screens, how to perform a BIOS update, and how to reset the password or CMOS. Information about the specific BIOS settings and screens is available in the Intel® 3000 Series Chipsets Server Board Family Datasheet. See "[Additional Information and Software](#)" for a link to the Intel® 3000 Series Chipsets Server Board Family Datasheet.

Chapter 3 provides instructions on adding and replacing components. Use this chapter for step-by-step instructions and diagrams for installing or replacing components such as the memory, processor, control panel board, and the battery, among other components.

Chapter 4 provides troubleshooting information. In this chapter, you will find BIOS error messages and POST code messages. You will also find suggestions for performing troubleshooting activities to identify the source of a problem.

Product Accessories

This server board is compatible with the following Intel® Server Chassis:

- Intel® Entry Server Chassis SC5295UP

You may need or want to purchase one or more of the following accessory items for your server:

Processor, memory DIMMs, hard drive, CD-ROM or DVD-ROM drive, RAID controller, operating system.

For information about which accessories, memory, processors, and third-party hardware have been tested and can be used with your board, and for ordering information for Intel products, see <http://support.intel.com/support/motherboards/server/S3000AH/compat.htm>.

Additional Information and Software

If you need more information about this product or information about the accessories that can be used with this server board, use the following resources. These files are available at <http://support.intel.com/support/motherboards/server/S3000AH/>

Unless otherwise indicated in the table below, once on this Web page, type the document or software name in the search field at the left side of the screen and select the option to search "This Product."

Table 1. Additional Information and Software

For this information or software	Use this Document or Software
For in-depth technical information about this product	<i>Intel® Server Board S3000AH Technical Product Specification</i>
For BIOS settings and chipset information	<i>Intel® Server Board S3000AH Technical Product Specification</i>
If you just received this product and need to install it	Intel® Server Board S3000AH <i>Quick Start User's Guide</i> in the product box
For virtual system tours and interactive repair information	A link to the SMaRT Tool is available under "Other Resources" at the right side of the screen at http://support.intel.com/support/motherboards/server/S3000AH
Accessories or other Intel server products	Spares and Configuration Guide

Table 1. Additional Information and Software

For this information or software	Use this Document or Software
Hardware (peripheral boards, adapter cards) and operating systems that have been tested with this product	Tested Hardware Operating Systems List
Chassis that have been tested with this product	Reference Chassis List
Processors that have been tested with this product	Supported Processors
DIMMs that have been tested with this product	Tested Memory List
To make sure your system falls within the allowed power budget	Power Budget Tool
For software to manage your Intel® server	Intel® System Management Software
For drivers	Driver (for an extensive list of available drivers) Operating System Driver (for operating system drivers)
For firmware and BIOS updates, or for BIOS recovery	Firmware Updates
For diagnostics test software	Diagnostics

See also the *Intel® Server Deployment Toolkit 2.0 CD* that came with your server board.

Contents

Safety Information	iii
Important Safety Instructions	iii
Wichtige Sicherheitshinweise	iii
Consignes de sécurité	iii
Instrucciones de seguridad importantes	iii
Warnings	v
Preface	vii
About this Manual	vii
Manual Organization	vii
Product Accessories	viii
Additional Information and Software	viii
Chapter 1: Server Board Features	1
RAID Support	4
SATA Server Board	4
Intel® Embedded Server RAID Technology	5
Intel® Matrix Storage Manager	5
Connector and Component Locations	6
Configuration Jumpers	12
Back Panel Connectors	13
Hardware Requirements	14
Processor	14
Memory	14
Power Supply	14
Optional Hardware	15
Hard Disk Drives	15
Chapter 2: Server Utilities	17
Using the BIOS Setup Utility	17
Starting Setup	17
If You Cannot Access Setup	17
Setup Menus	17
Upgrading the BIOS	19
Preparing for the Upgrade	19
Upgrading the BIOS	20
Chapter 3: Hardware Installations and Upgrades	23
Before You Begin	23
Tools and Supplies Needed	23
Installing and Removing Memory	23

Installing DIMMs	23
Removing DIMMs	25
Installing the Processor	26
Installing the Heat Sink(s)	28
Removing a Processor	29
Replacing the Backup Battery	30
Appendix A: Getting Help	33
World Wide Web	33
Telephone	33
Appendix B: Regulatory and Compliance Information	37
Product Regulatory Compliance	37
Product Safety Compliance	37
Certifications / Registrations / Declarations	38
Product Regulatory Compliance Markings	38
Electromagnetic Compatibility Notices	39
FCC (USA)	39
Industry Canada (ICES-003)	40
Europe (CE Declaration of Conformity)	40
Taiwan Declaration of Conformity (BSMI)	40
Korean Compliance (RRL)	41
CNCA (CCC-China)	41
Restriction of Hazardous Substances (RoHS) Compliance	42
End-of-Life / Product Recycling	42
Appendix C: Troubleshooting	43
Resetting the System	43
Problems following Initial System Installation	43
First Steps Checklist	44
Hardware Diagnostic Testing	44
Verifying Proper Operation of Key System Lights	45
Confirming Loading of the Operating System	45
Specific Problems and Corrective Actions	45
Power Light Does Not Light	46
No Characters Appear on Screen	46
Characters Are Distorted or Incorrect	47
System Cooling Fans Do Not Rotate Properly	47
CD-ROM Drive or DVD-ROM Drive Activity Light Does Not Light	48
Cannot Connect to a Server	48
Problems with Network	48
System Boots when Installing PCI Card	49
Problems with Newly Installed Application Software	49
Problems with Application Software that Ran Correctly Earlier	50
Devices are not Recognized under Device Manager (Windows* Operating System)	50

Hard Drive(s) are not Recognized	50
Bootable CD-ROM Disk Is Not Detected	51
LED Information	51
BIOS POST Beep Codes	52
Appendix D: Intel® Server Issue Report Form	53

List of Tables

Table 1. Additional Information and Software	viii
Table 2. Server Board Features	2
Table 3. NIC LED Descriptions	13
Table 4. Setup Menu Key Use	18
Table 5. Product Certification Markings	38
Table 6. Resetting the System	43
Table 7. LED Information	51
Table 8. POST Error Beep Codes	52

List of Figures

Figure 1. Intel® Server Board S3000AH (S3000AHLX shown)	1
Figure 2. Configuring SATA as RAID in BIOS Setup	4
Figure 3. S3000AHLX Connector and Component Locations.....	7
Figure 4. S3000AH Connector and Component Locations	9
Figure 5. S3000AHV Connector and Component Locations.....	11
Figure 6. Configuration Jumper Descriptions	12
Figure 7. Back Panel Connectors.....	13
Figure 8. CMOS Clear Jumper.....	21
Figure 9. Installing Memory	24
Figure 10. Lifting the Socket Handle	26
Figure 11. Open the Load Plate	26
Figure 12. Removing the Shipping Cover	27
Figure 13. Installing the Processor.....	27
Figure 14. Removing the Protective Socket Cover	27
Figure 15. Installing the Heat Sink	28
Figure 16. Replacing the Backup Battery.....	31

1 Server Board Features

This chapter briefly describes the main features of the Intel® Server Board S3000AH. This chapter provides a photograph of the product, a list of the server board features, and diagrams showing the location of important components and connections on the server board.

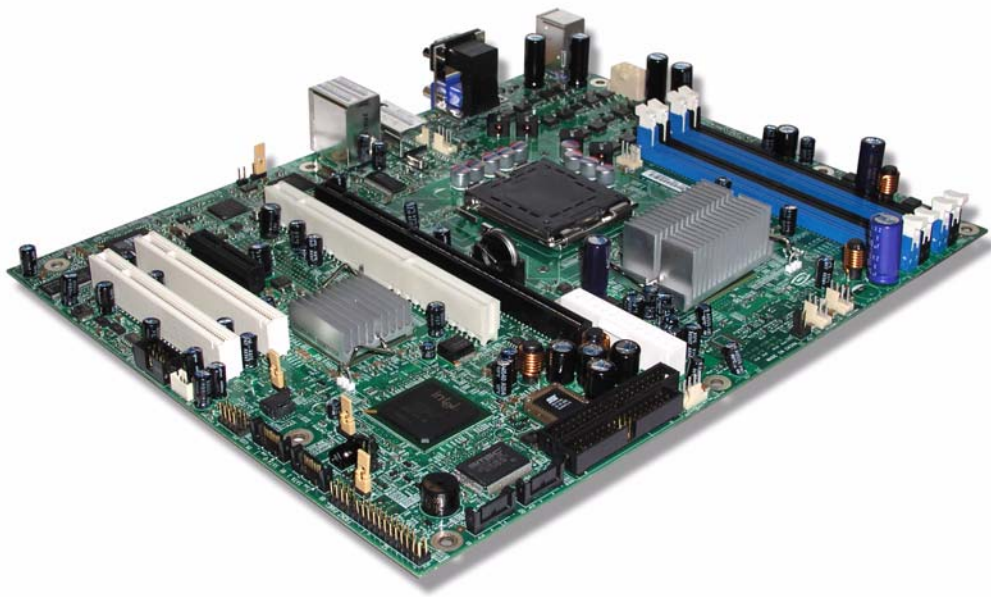

Figure 1. Intel® Server Board S3000AH (S3000AHLX shown)

Table 2 summarizes the features of the server board.

Table 2. Server Board Features

Feature	Description
Processor	Processor and Front Side Bus (FSB) support <ul style="list-style-type: none"> • Supports Dual-Core Intel® Xeon® processor 3000 series, Quad-Core Intel® Xeon® processor 3200 series, Intel® Pentium® processor Extreme Edition (S3000AHLX and S3000AH only), Intel® Pentium® D processors, Intel® Pentium® 4 processors, and Intel® Celeron® D processors in the Intel® LGA775 package • Supports Intel® dual-core technology • Supports Hyper-Threading Technology • Supports Intel® Extended Memory System 64 Technology (Intel® EM64T)
Memory	Four DIMM sockets supporting stacked DDR2 533/667 MHz ECC or non-ECC unbuffered memory (up to 8 GB of total system memory)
Chipset	Intel® 3000 chipset, consisting of: <ul style="list-style-type: none"> • Intel® 3000 Memory Controller Hub (MCH) • Intel® I/O Controller Hub (ICH7R) • Intel® 6702 PXH-V PCI-X* Hub (S3000AHLX SKU only)
Peripheral Interfaces	External connections: <ul style="list-style-type: none"> • Stacked PS/2* ports for keyboard and mouse • DB9 Serial A port • Two RJ45 NIC connectors for 10/100/1000 Mb connections • Two USB 2.0 ports Internal connections: <ul style="list-style-type: none"> • One USB port header, which supports two USB 2.0 ports • One DH10 Serial B header • Four Serial ATA connectors with embedded RAID 0/1/10 support for Intel® Embedded Server RAID Technology and RAID 0/1/5/10 for Intel® Matrix Storage Technology • One ATA-100 connector • ATX-compliant 24-pin control panel header
I/O Controll	SMSC* SCH5027 controller
Video	On-board ATI* ES1000 video controller with 16MB external video memory
Hard drive	<ul style="list-style-type: none"> • ATA-100 support: one IDE channel capable of supporting up to two drives • SATA (3.0 Gb/s) support
LAN	<ul style="list-style-type: none"> • Intel® 10/100/1000 82573E Gigabit Ethernet Controller • Intel® 10/100/1000 82541PI Gigabit Ethernet Controller (S3000AHLX/S3000AH only)

Table 2. Server Board Features

Feature	Description
Expansion Capabilities	<p>S3000AHLX SKU:</p> <ul style="list-style-type: none"> • Two full length 32-bit/33MHz, 3.3V Universal PCI connectors • One physical x4 PCI Express* connector (operating at x1 lane speed) • One full length PCI-X* connector (64-bit/133MHz) • One Intel® Adaptive Slot connector (supports one PCIe* x8 or one PCI-X* 64-bit/133MHz add-in card) <p>S3000AH SKU:</p> <ul style="list-style-type: none"> • Two full length 32-bit/33MHz, 3.3V Universal PCI connectors • One x8 PCI Express* connector • One physical x4 PCI Express* connector (operating at x1 lane speed) • One physical x8 PCI Express* connector (operating at x4 lane speed) <p>S3000AHV SKU:</p> <ul style="list-style-type: none"> • Two full length 32-bit/33MHz, 3.3V Universal PCI connectors • One x8 PCI Express* connector • One physical x8 PCI Express* connector (operating at x4 lane speed)
Fans	Support for up to four system fans and one processor fan
System Management	Intel® System Management Software

RAID Support

The Intel® Server Board S3000AH provides SATA (3.0 Gb/s) support.

For information on configuring RAID, see the RAID Software Guide that is included on the *Intel® Server Deployment Toolkit 2.0 CD*.

SATA Server Board

The Intel® Server Board S3000AH provides an embedded SATA controller that supports both 1.5 and 3.0 Gbps data transfer rates.

The BIOS Setup utility provides multiple drive configuration options on the Advanced | ATA Controller setup page, some of which affect the ability to configure RAID. The “Onboard SATA Controller” option is enabled by default. When this option is enabled, the “SATA Mode” option can be set to either Legacy or Enhanced. The Legacy and Enhanced modes affect the RAID configuration as follows:

- In Legacy mode, the BIOS can enumerate only four drives and does not provide RAID support.
- In Enhanced mode, the BIOS is not limited to legacy PATA four drive limitations and can enumerate the two PATA drives and four SATA drives (totalling six drives). This mode is required for RAID configurations.

When the enhanced mode is selected, you can choose to “Configure SATA as RAID”. Under SATA RAID OPROM: choosing the LSI* option (Intel® Embedded Server RAID Technology) will enable RAID 0, 1, and 10 while choosing Intel® Matrix Storage Technology will enable RAID 0, 1, 5, and 10.

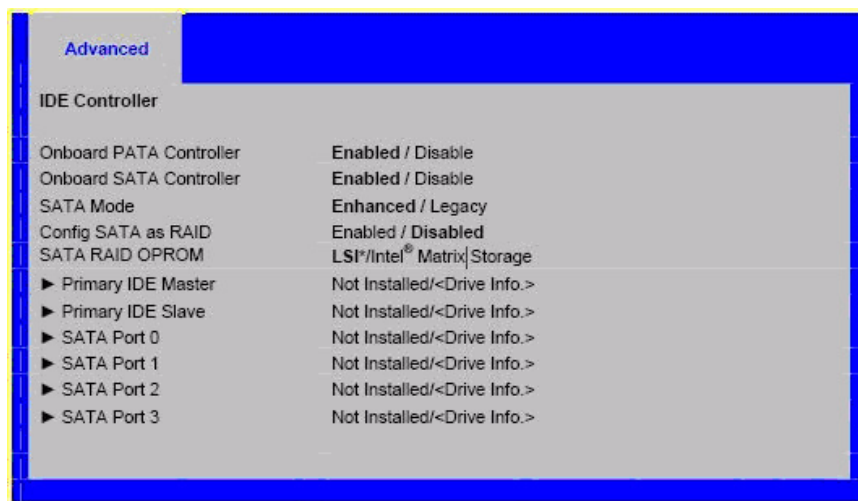

Figure 2. Configuring SATA as RAID in BIOS Setup

Notes: For assistance in navigating through the F2 BIOS Setup utility, see the Intel® Server Board S3000AH Technical Product Specification.

For information on setting up RAID, see the RAID Software Guide that is included on the Intel® Server Deployment Toolkit 2.0 CD.

Intel® Matrix Storage Technology supports software SATA RAID 0, 1, 10, and 5.

- Microsoft Windows* driver support only.

Intel® Embedded Server RAID Technology and the LSI* Logic SATA controller support software SATA RAID 0, 1, and 10.

- Driver support available for all supported operating systems.

Intel® Embedded Server RAID Technology

Intel® Embedded Server RAID Technology supports four Serial ATA ports, providing a cost-effective way to achieve higher transfer rates and reliability. Intel® Embedded Server RAID Technology supports

- RAID level 0 data striping for improved performance
- RAID level 1 data mirroring for improved data reliability
- RAID level 10 data striping and mirroring for high data transfer rates and data redundancy

Intel® Matrix Storage Manager

Intel® Matrix Storage Manager provides software support for high-performance Serial ATA RAID 0 arrays, fault-tolerant Serial ATA RAID 1 arrays, high capacity and fault-tolerant Serial ATA RAID 5 arrays, and high performance and fault-tolerant Serial ATA RAID 10 arrays on supported chipsets using select operating systems. Intel® Matrix Storage Manager is the software that enables Intel® Matrix Storage Technology.

For detailed information and supported OSes, please refer to the following website:

<http://support.intel.com/support/chipsets/imsm/>

Connector and Component Locations

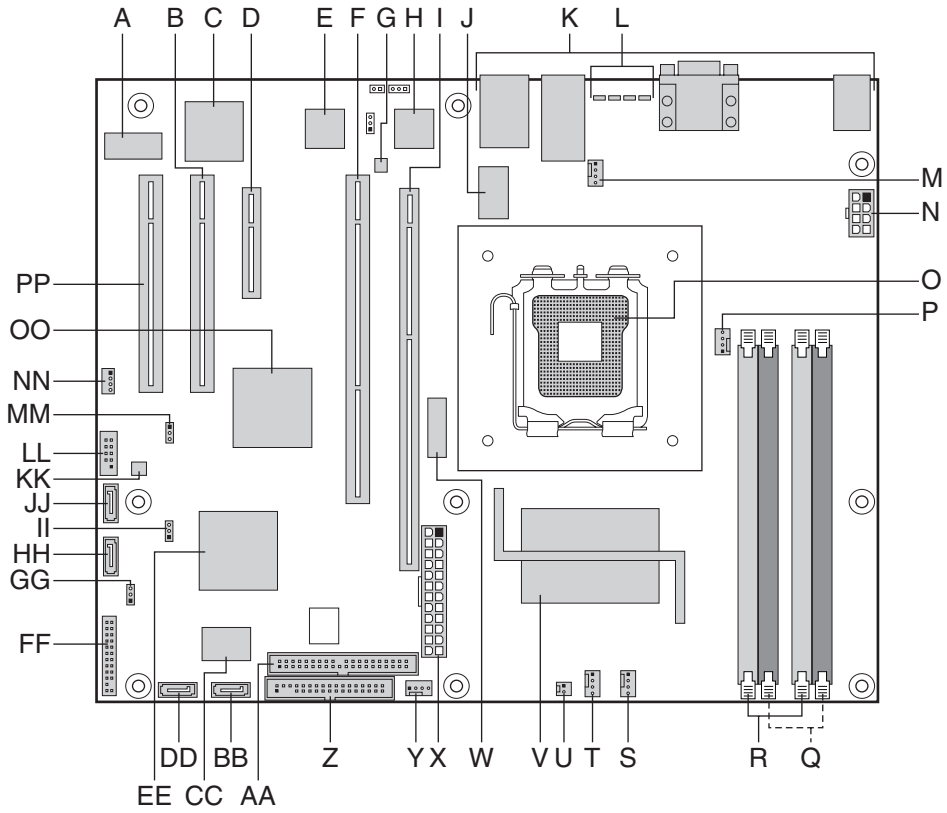

AF000537

A. Video Memory	B. PCI 32/33 Slot 2	C. ATI* ES1000 Video Controller
D. PCIe* x4 (x1 Lane) Slot 3	E. Intel® 82541PI Lan Controller	F. PCI-X* 64/133 Slot 5
G. LAN SPI Flash	H. Intel® 82573E LAN Controller	I. Intel® Adaptive Slot, Slot 6
J. Clock Generator	K. Back Panel Connectors	L. Diagnostic POST LEDs
M. Rear System Fan	N. 2x4 Power Connector	O. Processor Socket
P. Processor Fan	Q. DIMM Sockets (2B and 2A)	R. DIMM Sockets (1B and 1A)
S. System Front DIMM Blower Header	T. System Front Processor Blower Header	U. Chassis Intrusion Header
V. Intel® S3000 MCH	W. Battery	X. 2x12 Main Power Connector
Y. Front System Fan	Z. Floppy Connector	AA. PATA IDE Connector
BB. SATA Port 3	CC. SMSC* SCH5027 Super I/O	DD. SATA Port 2
EE. Intel® 82801 ICH7R	FF. Front Panel Connector	GG. System Maintenance Mode Jumper
HH. SATA Port 1	II. Clear CMOS Jumper	JJ. SATA Port 0
KK. BIOS SPI Flash	LL. External USB Connector	MM. SPI/FWH Select Header
NN. SMBus Connector	OO. Intel® 6702 PXH-V Controller	PP. PCI 32/33 Slot 1

Figure 3. S3000AHLX Connector and Component Locations

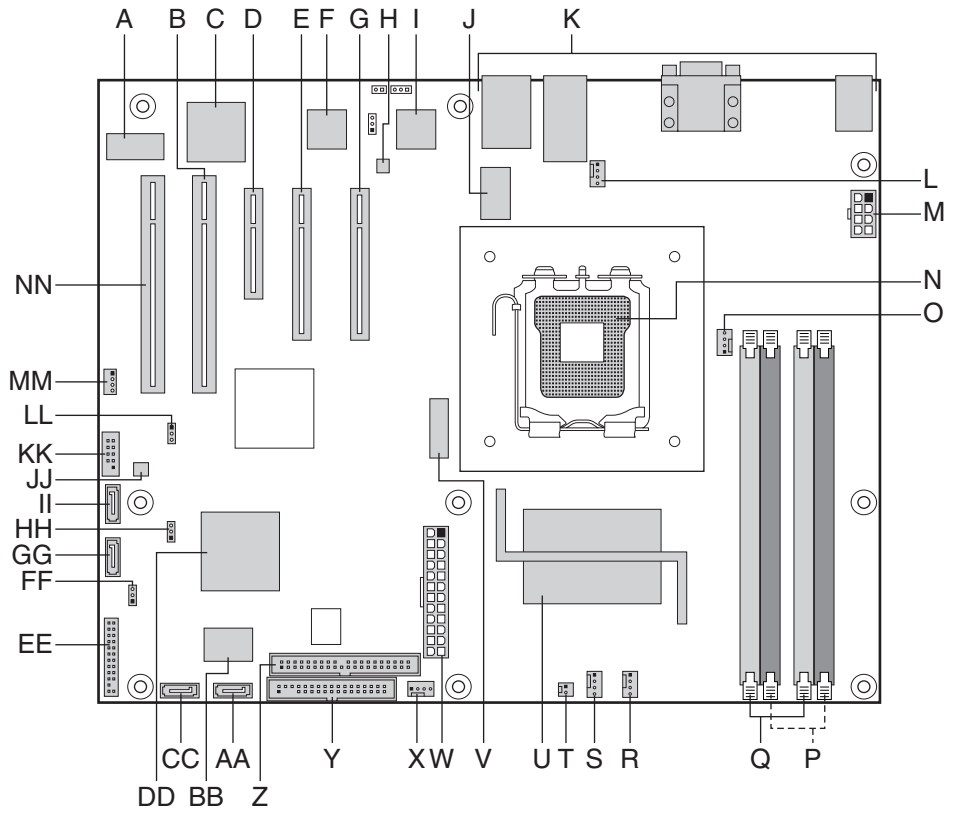

AF000538

A. Video Memory	B. PCI 32/33 Slot 2	C. ATI* ES1000 Video Controller
D. PCIe* x4 (x1 Lane) Slot 3	E. PCIe* x8 (x4 Lane) Slot 5	F. Intel® 82541PI Lan Controller
G. PCIe* x8 (x8 Lane) Slot 6	H. LAN SPI Flash	I. Intel® 82573E LAN Controller
J. Clock Generator	K. Back Panel Connectors	L. Rear System Fan
M. 2x4 Power Connector	N. Processor Socket	O. Processor Fan
P. DIMM Sockets (2B and 2A)	Q. DIMM Sockets (1B and 1A)	R. System Front DIMM Blower Header
S. System Front Processor Blower Header	T. Chassis Intrusion Header	U. Intel® S3000 MCH
V. Battery	W. 2x12 Main Power Connector	X. Front System Fan
Y. Floppy Connector	Z. PATA IDE Connector	AA. SATA Port 3
BB. SMSC* SCH5027 Super I/O	CC. SATA Port 2	DD. Intel® 82801 ICH7R
EE. Front Panel Connector	FF. System Maintenance Mode Jumper	GG. SATA Port 1
HH. Clear CMOS Jumper	II. SATA Port 0	JJ. BIOS SPI Flash
KK. External USB Connector	LL. SPI/FWH Select Header	MM. SMBus Connector
NN. PCI 32/33 Slot 1		

Figure 4. S3000AH Connector and Component Locations

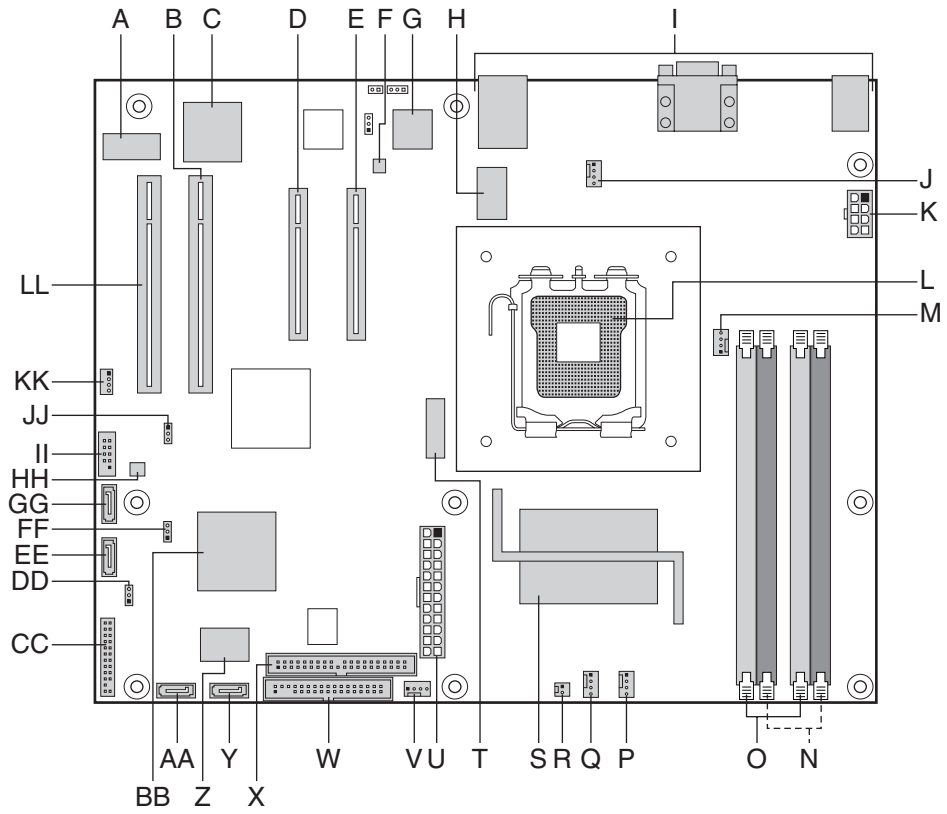

AF000539

A. Video Memory	B. PCI 32/33 Slot 2	C. ATI* ES1000 Video Controller
D. PCIe* x8 (x4 Lane) Slot 5	E. PCIe* x8 (x8 Lane) Slot 6	F. LAN SPI Flash
G. Intel® 82573E LAN Controller	H. Clock Generator	I. Back Panel Connectors
J. Rear System Fan	K. 2x4 Power Connector	L. Processor Socket
M. Processor Fan	N. DIMM Sockets (2B and 2A)	O. DIMM Sockets (1B and 1A)
P. System Front DIMM Blower Header	Q. System Front Processor Blower Header	R. Chassis Intrusion Header
S. Intel® S3000 MCH	T. Battery	U. 2x12 Main Power Connector
V. Front System Fan	W. Floppy Connector	X. PATA IDE Connector
Y. SATA Port 3	Z. SMSC* SCH5027 Super I/O	AA. SATA Port 2
BB. Intel® 82801 ICH7R	CC. Front Panel Connector	DD. System Maintenance Mode Jumper
EE. SATA Port 1	FF. Clear CMOS Jumper	GG. SATA Port 0
HH. BIOS SPI Flash	II. External USB Connector	JJ. SPI/FWH Select Header
KK. SMBus Connector	LL. PCI 32/33 Slot 1	

Figure 5. S3000AHV Connector and Component Locations

Configuration Jumpers

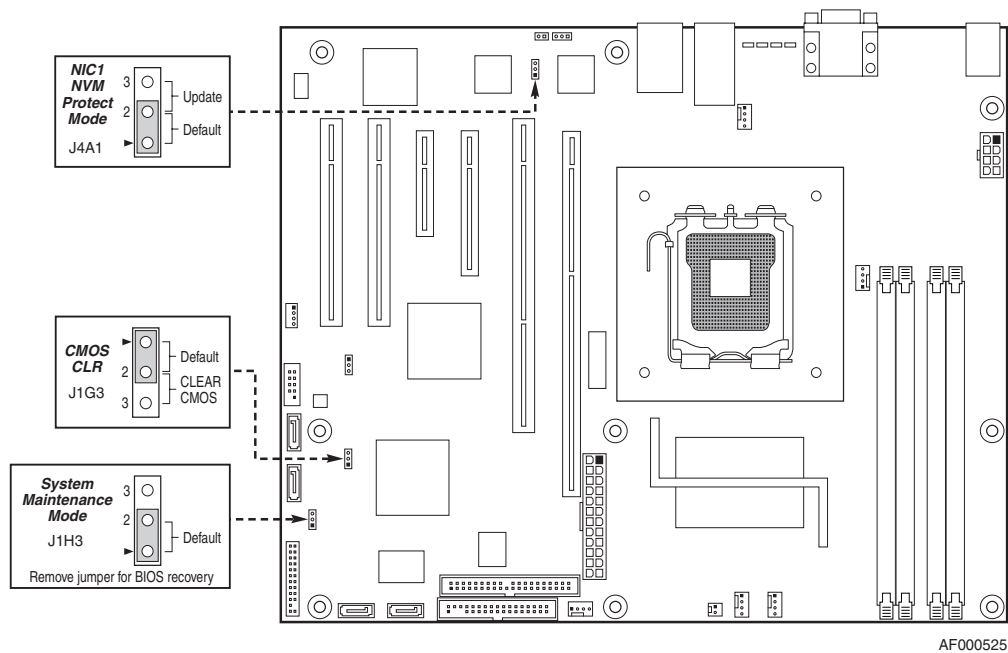

AF000525

Jumper Name	Jumper Purpose
NIC1 NVM Protect Mode	<p>Jumper in default position (pins 1-2) protects the Intel® 82573E/V firmware from being programmed.</p> <p>Jumper in update mode (pins 2-3) allows the Intel® 82573E/V firmware to be programmed.</p>
CMOS Clear	<p>Jumper in normal position (pins 1-2) allows the system to successfully POST and boot to the OS environment. BIOS settings are kept intact.</p> <p>Jumper in clear position (pins 2-3) initiates a clearing of NVRAM following POST. A system message confirms the CMOS clear operation was successful. This setting enforces default BIOS settings, which can be changed by entering setup via F2, then exiting setup via F10 and saving changes.</p>
System Maintenance Mode	<p>Jumper in normal position (pins 1-2) allows normal system operation with correct BIOS settings. System will POST normally.</p> <p>Jumper in maintenance mode (pins 2-3) allows Intel® AMT setting/password reset.</p> <p>Jumper removed is used to recover from a corrupted BIOS. Bootable media with a valid BIOS ROM required.</p>

Figure 6. Configuration Jumper Descriptions

Back Panel Connectors

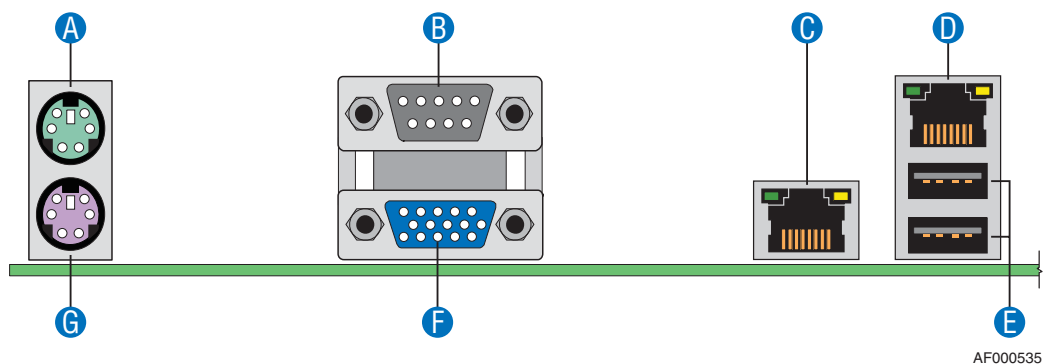

AF000535

A. Mouse	B. Serial Port A
C. NIC 1 (10/100/1000 Mb) S3000AH/S3000AHLX SKUs only	D. NIC 2 (10/100/1000 Mb)
E. USB 0-1	F. Video
G. Keyboard	

Figure 7. Back Panel Connectors

The NIC LEDs at the right and left of each NIC provide the following information.

Table 3. NIC LED Descriptions

LED	LED State	Description
Left	Off	No network connection
	Solid Green	Network connection in place
	Blinking Green	Transmit/receive activity
Right	N/A	10 Mbps connection (if left LED is on or blinking)
	Solid Green	100 Mbps connection
	Solid Yellow	1000 Mbps connection

Hardware Requirements

To avoid integration difficulties and possible board damage, your system must meet the requirements outlined below. For a list of qualified components, see the links under ["Additional Information and Software."](#)

Processor

Supports Dual-Core Intel® Xeon® processor 3000 series, Quad-Core Intel® Xeon® processor 3200 series, Intel® Pentium® processor Extreme Edition (S3000AHLX and S3000AH only), Intel® Pentium® D processors, Intel® Pentium® 4 processors, and Intel® Celeron® D processors in the Intel® LGA775 package. For a complete list of supported processors, see the links under ["Additional Information and Software."](#)

Memory

The Intel® Server Board S3000AH provides four DIMM sockets across two banks. Bank 1 consists of DIMM sockets 1A and 1B. Bank 2 consists of DIMM sockets 2A and 2B. Minimum memory operation is a single 256MB DIMM in socket 1A. This will provide single-channel interleave. For dual-channel interleave, two identical DIMMs are required in sockets 1A and 1B.

To operate in dual-channel dynamic paging mode, the following conditions must be met:

- Populate two identical DIMMs in sockets DIMM1A and DIMM 1B.
- Populate four identical DIMMs in each socket location.

Note: *The use of three DIMMs is not supported. Use DIMMs that are the same type and speed. Use of identical DIMMs is preferred.*

DIMMs must meet the following requirements:

- Use only DIMMs with DDR2 DRAM technology.
- Use only DDR2-533 and DDR2-667 stacked DIMM modules.

In determining your memory requirements, the need for memory sparing or memory mirroring must be considered. For a complete list of supported memory DIMMs, see the links under ["Additional Information and Software."](#)

Power Supply

A minimum of 350 Watts is required. Your supply must provide a minimum of 2A of 5V standby current or the board will not boot.

Optional Hardware

Hard Disk Drives

The Intel® Server Board S3000AH provides four SATA ports and one IDE connection. The four SATA ports are near the front left side of the server board. The IDE connection supports one or two ATA-100 devices. IDE devices can be connected to the standard IDE connector located near the SATA ports.

See the documentation included with your server chassis for additional drive information and drive installation instructions.

2 Server Utilities

Using the BIOS Setup Utility

This section describes the BIOS Setup Utility options, which is used to change server configuration defaults. You can run BIOS Setup with or without an operating system being present. See [“Additional Information and Software”](#) for a link to the Intel® S3000 Server Board Family Datasheet where you will find details about specific BIOS setup screens.

Starting Setup

You can enter and start BIOS Setup under several conditions:

- When you turn on the server, after POST completes the memory test.
- When you have moved the CMOS jumper on the server board to the "Clear CMOS" position (enabled).

In the two conditions listed above, during the Power On Self Test (POST), you will see this prompt:

```
Press <F2> to enter SETUP
```

In a third condition, when CMOS/NVRAM has been corrupted, you will see other prompts but not the <F2> prompt:

```
Warning: CMOS checksum invalid  
Warning: CMOS time and date not set
```

In this condition, the BIOS will load default values for CMOS and attempt to boot.

If You Cannot Access Setup

If you are not able to access BIOS Setup, you might need to clear the CMOS memory. For instructions on clearing the CMOS, see ["Clearing the CMOS"](#).

Setup Menus

Each BIOS Setup menu page contains a number of features. Except for those features that are provided only to display automatically configured information, each feature is associated with a value field that contains user-selectable parameters. These parameters can be changed if the user has adequate security rights. If a value cannot be changed for any reason, the feature's value field is inaccessible.

“Setup Menu Key Use” describes the keyboard commands you can use in the BIOS Setup menus.

Table 4. Setup Menu Key Use

Key to Press	Description
<F1>	Pressing <F1> on any menu invokes the general help window.
Left and right arrows	The left and right arrow keys are used to move between the major menu pages. The keys have no affect if a submenu or pick list is displayed.
Up arrow	Select Item up - The up arrow is used to select the previous value in a menu item's option list, or a value field pick list. Pressing the <Enter> key activates the selected item.
Down arrow	Select Item down - The down arrow is used to select the next value in a menu item's option list, or a value field pick list. Pressing the <Enter> key activates the selected item.
<F5> or <->	Change Value - The minus key or the <F5> function key is used to change the value of the current item to the previous value. This key scrolls through the values in the associated pick list without displaying the full list.
<F6> or <+>	Change Value - The plus key or the <F6> function key is used to change the value of the current menu item to the next value. This key scrolls through the values in the associated pick list without displaying the full list. On 106-key Japanese keyboards, the plus key has a different scan code than the plus key on the other keyboard, but it has the same effect.
<Enter>	Execute Command - The <Enter> key is used to activate submenus when the selected feature is a submenu, or to display a pick list if a selected feature has a value field, or to select a sub-field for multi-valued features like time and date. If a pick list is displayed, the <Enter> key will undo the pick list, and allow another selection in the parent menu.
<Esc>	Exit - The <Esc> key provides a mechanism for backing out of any field. This key will undo the pressing of the <Enter> key. When the <Esc> key is pressed while editing any field or selecting features of a menu, the parent menu is re-entered. When the <Esc> key is pressed in any submenu, the parent menu is re-entered. When the <Esc> key is pressed in any major menu, the exit confirmation window is displayed and the user is asked whether changes can be discarded.
<F9>	Setup Defaults - Pressing <F9> causes the following to appear: <pre style="margin-left: 40px;"> Setup Confirmation Load default configuration now? [Yes] [No] </pre> If "Yes" is selected and the <Enter> key is pressed, all Setup fields are set to their default values. If "No" is selected and the <Enter> key is pressed, or if the <Esc> key is pressed, the user is returned to where they were before <F9> was pressed without affecting any existing field values.

Table 4. Setup Menu Key Use

Key to Press	Description
<F10>	<p>Save and Exit - Pressing <F10> causes the following message to appear:</p> <pre> Setup Confirmation Save Configuration changes and exit now? [Yes] [No]</pre> <p>If "Yes" is selected and the <Enter> key is pressed, all changes are saved and Setup is exited. If "No" is selected and the <Enter> key is pressed, or the <Esc> key is pressed, the user is returned to where they were before <F10> was pressed without affecting any existing values.</p>

Upgrading the BIOS

The upgrade utility allows you to upgrade the BIOS in flash memory. The code and data in the upgrade file include the following:

- On-board system BIOS, including the recovery code, BIOS Setup Utility, and strings.
- On-board video BIOS, and other option ROMs for devices embedded on the server board.
- OEM binary area
- Microcode
- A way to change the BIOS language

Preparing for the Upgrade

The steps below explain how to prepare to upgrade the BIOS, including how to record the current BIOS settings and how to obtain the upgrade utility.

Note: *In the unlikely event that a BIOS error occurs during the BIOS update process, a recovery process may need to be followed to return the system to service. See “[Additional Information and Software](#)” for a link to necessary software and instructions.*

Recording the Current BIOS Settings

1. Boot the computer and press <F2> when you see the message:
Press <F2> Key if you want to run SETUP
2. Write down the current settings in the BIOS Setup program.

Note: *Do not skip step 2. You will need these settings to configure your computer at the end of the procedure.*

Obtaining the Upgrade

Download the BIOS image file to a temporary folder on your hard drive or a USB flash device. See [“Additional Information and Software”](#) for a link to the update software.

Note: *Review the instructions and release notes that are provided in the readme file distributed with the BIOS image file before attempting a BIOS upgrade. The release notes contain critical information regarding jumper settings, specific fixes, or other information to complete the upgrade.*

Upgrading the BIOS

Follow the instructions in the readme file that came with the BIOS upgrade. When the update completes, remove the bootable media from which you performed the upgrade.

Caution: *Do not power down the system during the BIOS update process! The system will reset automatically when the BIOS update process is completed.*

Note: *You may encounter a CMOS Checksum error or other problem after reboot. If this happens, shut down the system and boot it again. CMOS checksum errors require that you enter Setup, check your settings, save your settings, and exit Setup.*

Clearing the CMOS

If you are not able to access the BIOS setup screens, the CMOS Clear jumper will need to be used to reset the configuration RAM.

1. Power down the system and disconnect the AC power.
2. Open the server.
3. Move the jumper from the normal operation position, CMOS Clear by BMC, at pins 1 and 2 to the CMOS Clear Force Erase position, covering pins 2 and 3 as indicated in the following diagram.

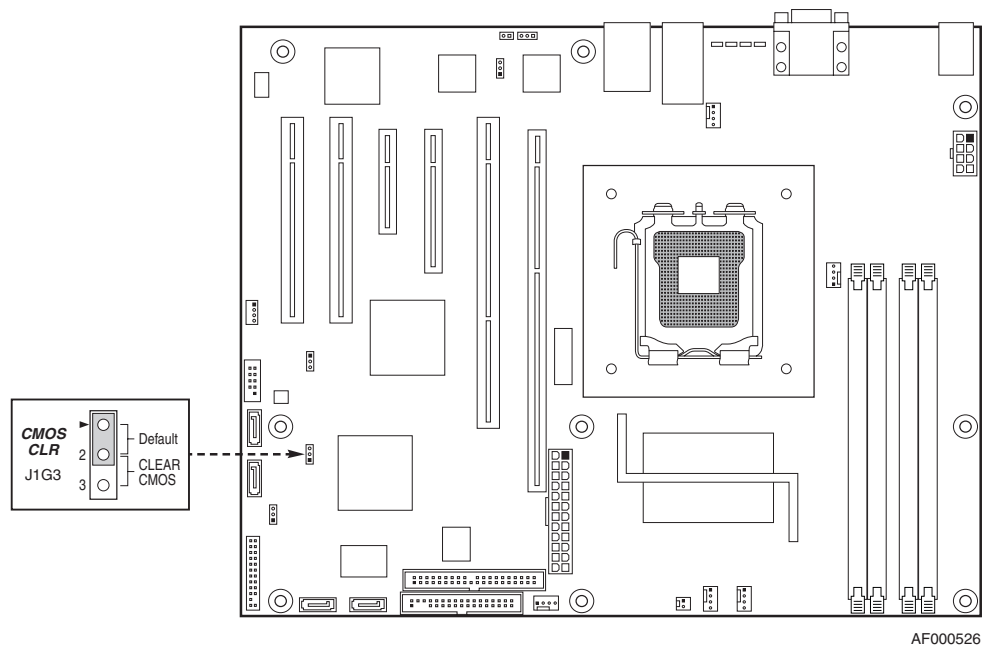

Figure 8. CMOS Clear Jumper

4. Reconnect the AC power, power up the system.
5. When the system begins beeping, power it down and disconnect the AC power.
6. Return the CMOS Clear jumper to the CMOS Clear by BMC location, covering pins 1 and 2.
7. Close the server chassis.
8. Reconnect the AC power and power up the system.

3 Hardware Installations and Upgrades

Before You Begin

Before working with your server product, pay close attention to the “[Safety Information](#)” at the beginning of this manual.

Tools and Supplies Needed

- Phillips* (cross head) screwdriver (#1 bit and #2 bit)
- Needle nosed pliers
- Antistatic wrist strap and conductive foam pad (recommended)

Installing and Removing Memory

The silkscreen on the board for the DIMMs displays DIMM 1A, DIMM 1B, DIMM 2A, and DIMM 2B starting from the center of the board. See "Memory" for a discussion of the memory requirements and options. See “[Additional Information and Software](#)” for a link to the list of tested DIMMs.

Installing DIMMs

To install DIMMs, follow these steps:

1. Observe the safety and ESD precautions in “[Safety Information](#)”.
2. Turn off all peripheral devices connected to the server. Turn off the server.
3. Disconnect the AC power cord from the server.
4. Remove the server's cover. See the documentation that came with your server chassis for instructions on removing the server's cover.
5. Locate the DIMM sockets (see [Figure 9](#)).

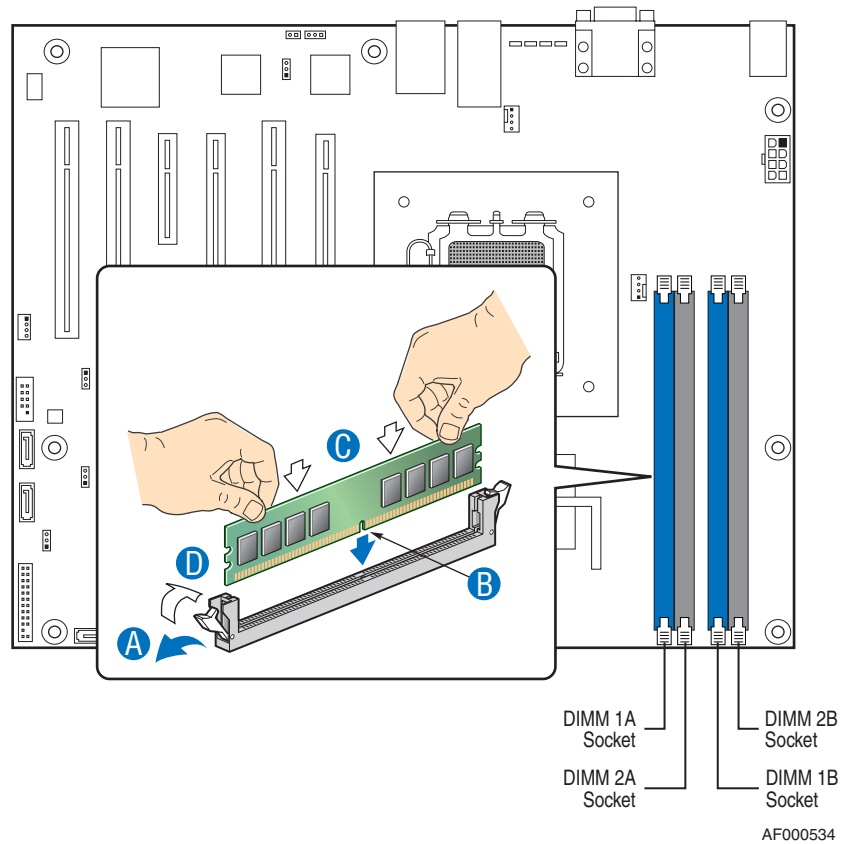

Figure 9. Installing Memory

6. Make sure the clips at either end of the DIMM socket(s) are pushed outward to the open position.
7. Holding the DIMM by the edges, remove it from its anti-static package.
8. Position the DIMM above the socket. Align the notch on the bottom edge of the DIMM with the key in the DIMM socket. The arrow in the inset in Figure 7 is pointing to the key in the socket.
9. Insert the bottom edge of the DIMM into the socket.
10. When the DIMM is inserted, push down on the top edge of the DIMM until the retaining clips snap into place. Make sure the clips are firmly in place.
11. Replace the server's cover and reconnect the AC power cord. See the documentation that came with your server chassis for instructions on installing the server's cover.

Removing DIMMs

To remove a DIMM, follow these steps:

1. Observe the safety and ESD precautions in [“Safety Information”](#).
2. Turn off all peripheral devices connected to the server. Turn off the server.
3. Remove the AC power cord from the server.
4. Remove the server's cover. See the documentation that came with your server chassis for instructions on removing the server's cover.
5. Gently spread the retaining clips at each end of the socket. The DIMM lifts from the socket.
6. Holding the DIMM by the edges, lift it from the socket, and store it in an anti-static package.
7. Reinstall and reconnect any parts you removed or disconnected to reach the DIMM sockets.
8. Replace the server's cover and reconnect the AC power cord. See the documentation that came with your server chassis for instructions on installing the server's cover.

Installing or Replacing the Processor

Caution: *Processor must be appropriate: You may damage the server board if you install a processor that is inappropriate for your server. See [“Additional Information and Software”](#) for a link to the list of compatible processor(s).*

Caution: *ESD and handling processors: Reduce the risk of electrostatic discharge (ESD) damage to the processor by doing the following: (1) Touch the metal chassis before touching the processor or server board. Keep part of your body in contact with the metal chassis to dissipate the static charge while handling the processor. (2) Avoid moving around unnecessarily.*

Installing the Processor

To install a processor, follow these instructions:

1. Observe the safety and ESD precautions in “[Safety Information](#)”.
2. Turn off all peripheral devices connected to the server. Turn off the server.
3. Disconnect the AC power cord from the server.
4. Remove the server's cover. See the documentation that came with your server chassis for instructions on removing the server's cover.
5. Locate the processor socket and raise the socket handle completely (see [Figure 10](#)).

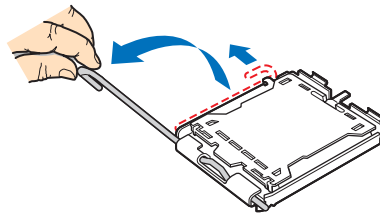

AF000528

Figure 10. Lifting the Socket Handle

6. Push the rear tab with your finger tip to bring the front end of the load plate up slightly. Open the load plate as shown (see [Figure 11](#)).

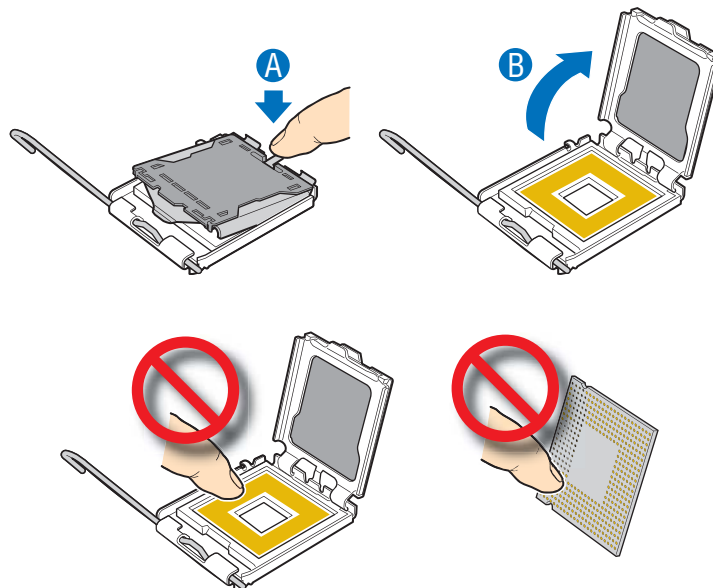

AF000529

Figure 11. Open the Load Plate

Note: Do not touch the socket pins; they are very sensitive and easily damaged.

7. Take the processor out of the box and remove the protective shipping cover (see [Figure 12](#)).



Figure 12. Removing the Shipping Cover

8. Orient the processor with the socket so that the processor cutouts match the socket notches. Install the processor as shown in [Figure 13](#).

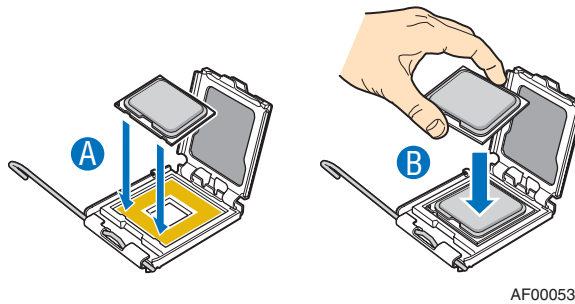

Figure 13. Installing the Processor

Note: Make sure the alignment triangle mark and the alignment triangle cutout align correctly.

9. Remove the protective socket cover (see [Figure 14](#)).

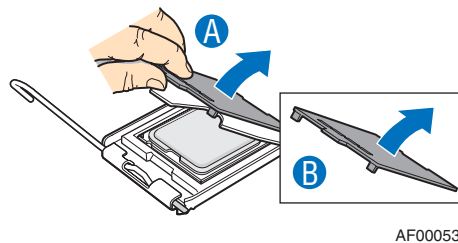

Figure 14. Removing the Protective Socket Cover

10. Lower the CPU load plate and lower the socket lever completely.

Note: Retain the protective socket cover for use when removing a processor that will not be replaced.

Installing the Heat Sink(s)

The heat sink has Thermal Interface Material (TIM) located on the bottom of it. Use caution when you unpack the heat sink so you do not damage the TIM.

1. Set the heat sink over the processor, lining up the four captive screws with the four posts surrounding the processor.
2. Loosely screw in the captive screws on the heat sink corners in a diagonal manner. Do not fully tighten one screw before tightening another.
3. Gradually and equally tighten each captive screw until each is firmly tightened.

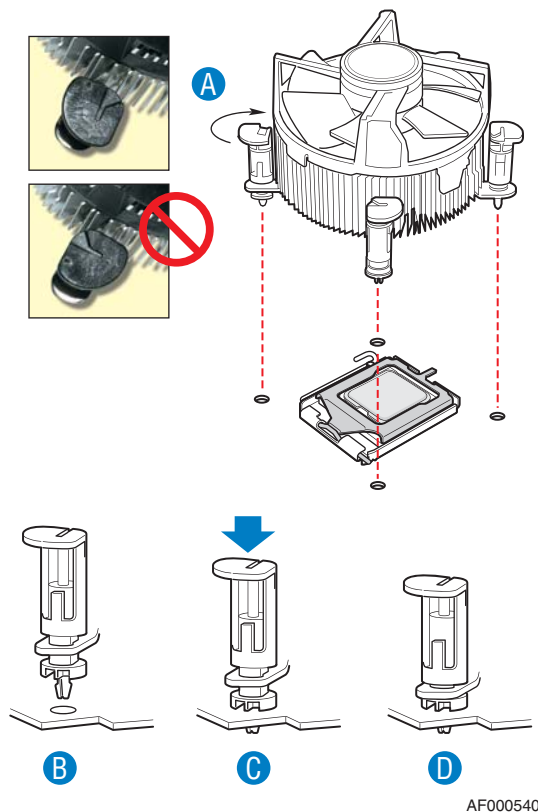

Figure 15. Installing the Heat Sink

4. Reinstall and reconnect any parts you removed or disconnected to reach the processor sockets.
5. Replace the server's cover and reconnect the AC power cord. See the documentation that came with your server chassis for instructions on installing the server's cover.

Removing a Processor

1. Observe the safety and ESD precautions in [“Safety Information”](#).
2. Turn off all peripheral devices connected to the server. Turn off the server.
3. Remove the AC power cord from the server.
4. Remove the server's cover. See the documentation that came with your server chassis for instructions on removing the server's cover.
5. Unplug the processor fan cable from the server board.
6. Loosen the four captive screws on the corners of the heat sink.
7. Twist the heat sink slightly to break the seal between the heat sink and the processor.
8. Lift the heat sink from the processor. If it does not pull up easily, twist the heat sink again. Do not force the heat sink from the processor. Doing so could damage the processor.
9. Lift the processor lever.
10. Raise the CPU load plate.
11. Remove the processor.
12. If installing a replacement processor, see [“Installing the Processor”](#). Otherwise, install the protective socket cover over the empty processor socket and reinstall the chassis cover.

Replacing the Backup Battery

The lithium battery on the server board powers the RTC for up to 10 years in the absence of power. When the battery starts to weaken, it loses voltage, and the server settings stored in CMOS RAM in the RTC (for example, the date and time) may be wrong. Contact your customer service representative or dealer for a list of approved devices.

Warning: *Danger of explosion if battery is incorrectly replaced. Replace only with the same or equivalent type recommended by the equipment manufacturer. Discard used batteries according to manufacturer's instructions.*

Advarsel: Lithiumbatteri - Eksplosionsfare ved fejlagtig håndtering. Udskiftning må kun ske med batteri af samme fabrikat og type. Levér det brugte batteri tilbage til leverandøren.

Advarsel: Lithiumbatteri - Eksplosjonsfare. Ved utskifting benyttes kun batteri som anbefalt av apparatfabrikanten. Brukt batteri returneres apparatleverandøren.

Warning: Explosionsfara vid felaktigt batteribyte. Använd samma batterityp eller en ekvivalent typ som rekommenderas av apparattillverkaren. Kassera använt batteri enligt fabrikantens instruktion.

Varoitus: Paristo voi räjähtää, jos se on virheellisesti asennettu. Vaihda paristo ainoastaan laitevalmistajan suosittelemaan tyyppiin. Hävitä käytetty paristo valmistajan ohjeiden mukaisesti.

1. Observe the safety and ESD precautions in “[Safety Information](#)”.
2. Turn off all peripheral devices connected to the server. Turn off the server.
3. Disconnect the AC power cord from the server.
4. Remove the server's cover and locate the battery. See the documentation that came with your server chassis for instructions on removing the server's cover.
5. Insert the tip of a small flat bladed screwdriver, or an equivalent, under the tab in the plastic retainer. Gently push down on the screwdriver to lift the battery.
6. Remove the battery from its socket.

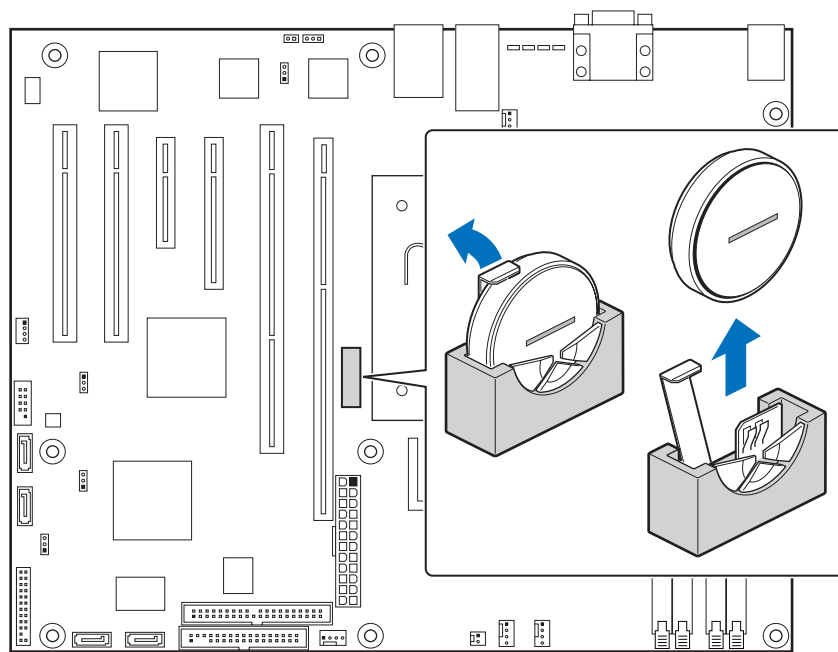

AF000524

Figure 16. Replacing the Backup Battery

7. Dispose of the battery according to local ordinance.
8. Remove the new lithium battery from its package, and, being careful to observe the correct polarity, insert it in the battery socket.
9. Close the chassis.
10. Run Setup to restore the configuration settings to the RTC.

Appendix A: Getting Help

World Wide Web

<http://support.intel.com/support/motherboards/server/S3000AH>.

Telephone

All calls are billed per incident, levied in local currency at the applicable credit card exchange rate plus applicable taxes. (Intel reserves the right to change the pricing for telephone support at any time without notice).

Before calling, fill out an “[Intel® Server Issue Report Form](#)”. A sample form is provided on the following pages. However, for the fastest service, please submit your form via the Internet.

For an updated support contact list, see <http://www.intel.com/support/9089.htm/>

U.S. and Canada

1-800-404-2284

Europe

Belgium 02 714 3182

Denmark ... 38 487077

Finland 9 693 79297

France..... 01 41 918529

Germany ... 069 9509 6099

Holland 020 487 4562

Italy..... 02 696 33276

Norway 23 1620 50

Spain..... 91 377 8166

Sweden..... 08 445 1251

UK..... 870 6072439

In Asia-Pacific Region

Australia.... 1800 649931

Cambodia.. 63 2 636 9797 (via Philippines)

China 800 820 1100 (toll-free)
..... 8 621 33104691 (not toll-free)

Hong Kong 852 2 844 4456

India..... 0006517 2 68303634 (manual toll-free. You need an IDD-equipped telephone)

Indonesia ... 803 65 7249

Korea 822 767 2595

Malaysia 1 800 80 1390

Myanmar... 63 2 636 9796 (via Philippines)

New Zealand 0800 444 365

Pakistan.... 632 63684 15 (IDD via Philippines)

Philippines 1 800 1 651 0117

Singapore .. 65 6213-1311

Taiwan 2 2545-1640

Thailand 1 800 631 0003

Vietnam 632 6368416 (IDD via Philippines)

Japan

Domestic.... 0120 868686

Outside country 81 298 47 0800

Latin America

Argentina .. Contact AT&T USA at 0-800 222 1288. Once connected, dial 800 843 4481

Brazil 001-916 377 0180

Chile

Easter Island. Contact AT&T USA at 800 800 311. Once connected, dial 800 843 4481

Mainland and Juan .. Contact AT&T USA at 800 225 288. Once connected, dial 800 843 4481

Colombia... Contact AT&T USA at 01 800 911 0010. Once connected, dial 800 843 4481

Costa Rica . Contact AT&T USA at 0 800 0 114 114. Once connected, dial 800 843 4481

Ecuador

(Andimate) Contact AT&T USA at 1 999 119. Once connected, dial 800 843 4481

(Pacifictel) Contact AT&T USA at 1 800 225 528. Once connected, dial 800 843 4481

Guatemala. Contact AT&T USA at 99 99 190. Once connected, dial 800 843 4481

Mexico Contact AT&T USA at 001 800 462 628 4240. Once connected, dial 800 843 4481

Miami 1 800 621 8423

Panama..... Contact AT&T USA at 00 800 001 0109. Once connected, dial 800 843 4481

Paraguay ... 001 916 377 0114

Peru 001 916 377 0114

Uruguay..... 001 916 377 0114

Venezuela... Contact AT&T USA at 0 800 2255 288. Once connected, dial 800 843 4481

Appendix B: Regulatory and Compliance Information

Product Regulatory Compliance

Product Safety Compliance

The Intel® Server Board S3000AH complies with the following safety requirements:

- UL60950 - CSA 60950 (USA / Canada)
- EN60950 (Europe)
- IEC60950 (International)
- CB Certificate & Report, IEC60950 (report to include all country national deviations)
- GOST R 50377-92 - Listed on one System License (Russia)
- Belarus License - Listed on System License (Belarus)
- CE - Low Voltage Directive 73/23/EEE (Europe)
- IRAM Certification (Argentina)

Product EMC Compliance - Class A Compliance

Note: *Legally this product is required to comply with Class A emission requirements as it is intended for a commercial type market place. Intel targets 10db margin to Class A Limits.*

The Intel® Server Board S3000AH has been tested and verified to comply with the following electromagnetic compatibility (EMC) regulations when installed a compatible Intel® host system. For information on compatible host system(s) see Intel's Server Builder Web site or contact your local Intel representative.

- FCC /ICES-003 - Emissions (USA/Canada) Verification
- CISPR 22 - Emissions (International)
- EN55022 - Emissions (Europe)
- EN55024 - Immunity (Europe)
- CE - EMC Directive 89/336/EEC (Europe)
- AS/NZS 3548 Emissions (Australia / New Zealand)
- BSMI CNS13438 Emissions (Taiwan)
- GOST R 29216-91 Emissions - Listed on one System License (Russia)

- GOST R 50628-95 Immunity -Listed on one System License (Russia)
- Belarus License - Listed on one System License (Belarus)
- RRL MIC Notice No. 1997-41 (EMC) & 1997-42 (EMI) (Korea)

Certifications / Registrations / Declarations

- UL Certification (US/Canada)
- CE Declaration of Conformity (CENELEC Europe)
- FCC/ICES-003 Class A Attestation (USA/Canada)
- C-Tick Declaration of Conformity (Australia)
- MED Declaration of Conformity (New Zealand)
- BSMI Certification (Taiwan)
- GOST - Listed on one System License (Russia)
- Belarus - Listed on one System License (Belarus)
- RRL Certification (Korea)
- Ecology Declaration (International)

Product Regulatory Compliance Markings

This product is marked with the following Product Certification Markings:

Table 5. Product Certification Markings



Regulatory Compliance	Region	Marking
UL Mark	USA/Canada	
CE Mark	Europe	
FCC Marking (Class A)	USA	This device complies with Part 15 of the FCC Rules. Operation of this device is subject to the following two conditions: (1) This device may not cause harmful interference, and (2) This device must accept any interference received, including interference that may cause undesired operation. Manufactured by Intel Corporation
EMC Marking (Class A)	Canada	CANADA ICES-003 CLASS A CANADA NMB-003 CLASSE A

Table 5. Product Certification Markings

Regulatory Compliance	Region	Marking
BSMI Marking (Class A)	Taiwan	 <div data-bbox="816 506 1268 621" style="border: 1px solid black; padding: 5px;"> <p>警告使用者： 這是甲類的資訊產品，在居住的環境中使用時，可能會造成射頻干擾，在這種情況下，使用者會被要求採取某些適當的對策</p> </div>
RLL MIC Mark	Korea	 <p data-bbox="833 737 950 758">인증번호: CPU</p>

Electromagnetic Compatibility Notices

FCC (USA)

This device complies with Part 15 of the FCC Rules. Operation is subject to the following two conditions: (1) this device may not cause harmful interference, and (2) this device must accept any interference received, including interference that may cause undesired operation.

For questions related to the EMC performance of this product, contact:

Intel Corporation
5200 N.E. Elam Young Parkway
Hillsboro, OR 97124-6497
1-800-628-8686

This equipment has been tested and found to comply with the limits for a Class A digital device, pursuant to Part 15 of the FCC Rules. These limits are designed to provide reasonable protection against harmful interference in a residential installation. This equipment generates, uses, and can radiate radio frequency energy and, if not installed and used in accordance with the instructions, may cause harmful interference to radio communications. However, there is no guarantee that interference will not occur in a particular installation. If this equipment does cause harmful interference to radio or television reception, which can be determined by turning the equipment off and on, the user is encouraged to try to correct the interference by one or more of the following measures:

- Reorient or relocate the receiving antenna.
- Increase the separation between the equipment and the receiver.
- Connect the equipment to an outlet on a circuit other than the one to which the receiver is connected.

- Consult the dealer or an experienced radio/TV technician for help.

Any changes or modifications not expressly approved by the grantee of this device could void the user's authority to operate the equipment. The customer is responsible for ensuring compliance of the modified product.

Only peripherals (computer input/output devices, terminals, printers, etc.) that comply with FCC Class A or B limits may be attached to this computer product. Operation with noncompliant peripherals is likely to result in interference to radio and TV reception.

All cables used to connect to peripherals must be shielded and grounded. Operation with cables, connected to peripherals, that are not shielded and grounded may result in interference to radio and TV reception.

Industry Canada (ICES-003)

Cet appareil numérique respecte les limites bruits radioélectriques applicables aux appareils numériques de Classe A prescrites dans la norme sur le matériel brouilleur: "Appareils Numériques", NMB-003 édictée par le Ministre Canadien des Communications.

This digital apparatus does not exceed the Class A limits for radio noise emissions from digital apparatus set out in the interference-causing equipment standard entitled: "Digital Apparatus," ICES-003 of the Canadian Department of Communications.

Europe (CE Declaration of Conformity)

This product has been tested in accordance too, and complies with the Low Voltage Directive (73/23/EEC) and EMC Directive (89/336/EEC). The product has been marked with the CE Mark to illustrate its compliance.

Taiwan Declaration of Conformity (BSMI)

<p>警告使用者： 這是甲類的資訊產品，在居住的環境中使用時，可能會造成射頻干擾，在這種情況下，使用者會被要求採取某些適當的對策</p>

The BSMI Certification Marking and EMC warning is located on the outside rear area of the product.

Korean Compliance (RRL)



1. 기기의 명칭(모델명) :
2. 인증번호 :
3. 인증받은 자의 상호 :
4. 제조년월일 :
5. 제조자/제조국가 :

English translation of the notice above:

1. Type of Equipment (Model Name): On License and Product
2. Certification No.: On RRL certificate. Obtain certificate from local Intel representative
3. Name of Certification Recipient: Intel Corporation
4. Date of Manufacturer: Refer to date code on product
5. Manufacturer/Nation: Intel Corporation/Refer to country of origin marked on product

CNCA (CCC-China)

The CCC Certification Marking and EMC warning is located on the outside rear area of the product.

声明

此为A级产品，在生活环境中，该产品可能会造成无线电干扰。在这种情况下，可能需要用户对其干扰采取可行的措施。

Restriction of Hazardous Substances (RoHS) Compliance

Intel has a system in place to restrict the use of banned substances in accordance with the European Directive 2002/95/EC. Compliance is based on declaration that materials banned in the RoHS Directive are either (1) below all applicable substance threshold limits or (2) an approved/pending RoHS exemption applies.

Note: RoHS implementing details are not fully defined and may change.

Threshold limits and banned substances are noted below.

- Quantity limit of 0.1% by mass (1000 PPM) for:
 - Lead
 - Mercury
 - Hexavalent Chromium
 - Polybrominated Biphenyls Diphenyl Ethers (PBDE)
- Quantity limit of 0.01% by mass (100 PPM) for:
 - Cadmium

End-of-Life / Product Recycling

Product recycling and end-of-life take-back systems and requirements vary by country. Contact the retailer or distributor of this product for information about product recycling and / or take-back.

Appendix C: Troubleshooting

This chapter helps you identify and solve problems that might occur while you are using the system.

For any issue, first ensure you are using the latest firmware and files. Firmware upgrades include updates for BIOS, the baseboard management controller (BMC), and the hot-swap controller (HSC). See [“Additional Information and Software”](#) for a link to the software updates. In addition to the server firmware and files, also update any drivers used for components you have installed in your system, such as video drivers, network drivers, and SCSI drivers.

Intel provides a package called the "Platform Confidence Test" that may help with your diagnostics. See [“Additional Information and Software”](#) for a link to this software.

If you are unable to resolve your server problems on your own, see [“Getting Help”](#) for assistance.

Resetting the System

Before going through in-depth troubleshooting, attempt first to perform reset your system using one of the methods below.

Table 6. Resetting the System

To do this	Press
Soft boot reset to clear the system memory and reload the operating system	<Ctrl+Alt+Del>
Clear system memory, restart POST, and reload the operating system	Reset button
Cold boot reset. Turn the system power off and then on. This clears system memory, restarts POST, reloads the operating system, and halts power to all peripherals	Power off/on button

Problems following Initial System Installation

Problems that occur at initial system startup are usually caused by an incorrect installation or configuration. Hardware failure is a less frequent cause. If the problem you are experiencing is with a specific software application, see [“Problems with Newly Installed Application Software”](#).

First Steps Checklist

- Is AC power available at the wall outlet?
- Are the power supplies plugged in? Check the AC cable(s) on the back of the chassis and at the AC source.
- Are all cables correctly connected and secured?
- Are the processors fully seated in their sockets on the server board?
- Are all standoffs in the proper location and not touching any components, causing a potential short?
- Are all add-in PCI boards fully seated in their slots on the server board?
- Are all jumper settings on the server board correct?
- Are all jumper and switch settings on add-in boards and peripheral devices correct? To check these settings, refer to the manufacturer's documentation that comes with them. If applicable, ensure that there are no conflicts—for example, two add-in boards sharing the same interrupt.
- Are all peripheral devices installed correctly?
- If the system has a hard disk drive, is it properly formatted or configured?
- Are all device drivers properly installed?
- Are the configuration settings made in Setup correct?
- Is the operating system properly loaded? See the operating system documentation.
- Did you press the system power on/off switch on the front panel to turn the server on (power on light should be lit)?
- Is the system power cord properly connected to the system and plugged into a NEMA 5 15R outlet for 100-120V or a NEMA 6-15R outlet for 200-240V ?
- Are all integrated components from the tested components lists? Check the tested memory, and chassis lists, as well as the supported hardware and operating system list. See [“Additional Information and Software”](#) for links to the tested component lists.

Hardware Diagnostic Testing

This section provides a more detailed approach to identifying a hardware problem and locating its source.

Caution: *Turn off devices before disconnecting cables: Before disconnecting any peripheral cables from the system, turn off the system and any external peripheral devices. Failure to do so can cause permanent damage to the system and/or the peripheral devices.*

1. Turn off the system and all external peripheral devices. Disconnect each device from the system, except for the keyboard and the video monitor.
2. Make sure the system power cord is plugged into a properly grounded AC outlet.

3. Make sure your video display monitor and keyboard are correctly connected to the system. Turn on the video monitor. Set its brightness and contrast controls to at least two thirds of their maximum ranges (see the documentation supplied with your video display monitor).
4. If the operating system normally loads from the hard disk drive, make sure there is no diskette in drive A and no CD-ROM disk in the CD-ROM drive.
5. If the power LED does light, attempt to boot from a CD-ROM disk.
6. Turn on the system. If the power LED does not light, see [“Power Light Does Not Light”](#).

Verifying Proper Operation of Key System Lights

As POST determines the system configuration, it tests for the presence of each mass storage device installed in the system. As each device is checked, its activity light should turn on briefly. Check for the following:

- Does the diskette drive activity light turn on briefly? If not, see [“CD-ROM Drive or DVD-ROM Drive Activity Light Does Not Light”](#).
- If system LEDs are illuminated, see [“Make sure the BIOS is configured to allow the CD-ROM to be the first bootable device.”](#) for a description of the light and steps to take to correct the problem.

Confirming Loading of the Operating System

Once the system boots up, the operating system prompt appears on the screen. The prompt varies according to the operating system. If the operating system prompt does not appear, see [“No Characters Appear on Screen”](#).

Specific Problems and Corrective Actions

This section provides possible solutions for these specific problems:

- Power light does not light.
- No characters appear on screen.
- Characters on the screen appear distorted or incorrect.
- System cooling fans do not rotate.
- Diskette drive activity light does not light.
- Hard disk drive activity light does not light.
- CD-ROM drive activity light does not light.
- There are problems with application software.
- The bootable CD-ROM is not detected.

Try the solutions below in the order given. If you cannot correct the problem, contact your service representative or authorized dealer for help.

Power Light Does Not Light

Check the following:

- Did you press the power-on button?
- Is the system operating normally? If so, the power LED might be defective or the cable from the control panel to the server board might be loose.
- Have you securely plugged the server AC power cord into the power supply?
- Some ATX power supplies have a power switch on the back of the power supply, next to the fan. If your system has one, is it turned on?
- Remove all add-in cards and see if the system boots. If successful, add the cards back in one at a time with a reboot between each addition.
- Make sure the memory DIMMs comply with the system requirements.
- Make sure the memory DIMMs have been populated according to the system requirements.
- Remove the memory DIMMs and re-seat them.
- Make sure the processor(s) comply with the system requirements.
- Make sure the processor(s) have been populated according to the system requirements.
- Remove the processor(s) and re-seat them.
- Make sure the chassis standoffs are installed only below mounting holes. Misplaced standoffs can contact the pins on the bottom of the server board and cause a short.

No Characters Appear on Screen

Check the following:

- Is the keyboard functioning? Test it by turning the "Num Lock" function on and off to make sure the Num Lock light is functioning.
- Is the video monitor plugged in and turned on? If you are using a switch box, is it switched to the correct system?
- Are the brightness and contrast controls on the video monitor properly adjusted?
- Is the video monitor signal cable properly installed?
- Does this video monitor work correctly if plugged into a different system?
- Is the onboard video controller enabled in the BIOS?
- Remove all add-in cards and see if the video returns. If successful, add the cards back in one at a time with a reboot between each addition.
- Make sure the memory DIMMs comply with the system requirements.

- Make sure the memory DIMMs have been populated according to the system requirements.
- Remove the memory DIMMs and re-seat them.
- Make sure the processor(s) comply with the system requirements.
- Make sure the processor(s) have been populated according to the system requirements.
- Remove the processor(s) and re-seat them.

If you are using an add-in video controller board, do the following:

1. Verify that the video works using the onboard video controller.
2. Verify that the video controller board is fully seated in the server board connector.
3. Reboot the system for changes to take effect.
4. If there are still no characters on the screen after you reboot the system and POST emits a beep code, write down the beep code you hear. This information is useful for your service representative.
5. If you do not receive a beep code and characters do not appear, the video display monitor or video controller may have failed. Contact your service representative or authorized dealer for help.

Characters Are Distorted or Incorrect

Check the following:

- Are the brightness and contrast controls properly adjusted on the video monitor? See the manufacturer's documentation.
- Are the video monitor's signal and power cables properly installed?
- Does this video monitor work correctly if plugged into a different system?

System Cooling Fans Do Not Rotate Properly

If the system cooling fans are not operating properly, it is an indication of possible system component failure.

Check the following:

- Is the power-on light lit? If not, see [“Power Light Does Not Light”](#).
- If your system has LED lights for the fans, is one or more of these LEDs lit?
- Are any other control panel LEDs lit?
- Have any of the fan motors stopped? Use the server management subsystem to check the fan status.
- Have your fans speeded up in response to an overheating situation?
- Have your fans speeded up in response to a fan that has failed?

- Are the fan power connectors properly connected to the server board?
- Is the cable from the control panel board connected to the both the control panel board and to the server board?
- Are the power supply cables properly connected to the server board?
- Are there any shorted wires caused by pinched-cables or have power connector plugs been forced into power connector sockets the wrong way?

CD-ROM Drive or DVD-ROM Drive Activity Light Does Not Light

Check the following:

- Are the CD-ROM/DVD-ROM drive's power and signal cables properly installed?
- Are all relevant switches and jumpers on the drive set correctly?
- Is the drive properly configured?

Cannot Connect to a Server

- Make sure the network cable is securely attached to the correct connector at the system back panel.
- Try a different network cable.
- Make sure you are using the correct and the current drivers. See [“Additional Information and Software”](#) for a link to the current drivers.
- Make sure the driver is loaded and the protocols are bound.
- Make sure the hub port is configured for the same duplex mode as the network controller.
- Make sure the correct networking software is installed.
- If you are directly connecting two servers (without a hub), you will need a crossover cable.
- Check the network controller LEDs next to the NIC connectors.

Problems with Network

The server hangs when the drivers are loaded

- Certain drivers may require interrupts that are not shared with other PCI drivers. For these drivers, it may be necessary to alter settings so that interrupts are not shared. See the documentation that came with your PCI card(s) for information on changing interrupts.

Diagnostics pass but the connection fails

- Make sure the network cable is securely attached.
- Make sure you specify the correct frame type in your NET.CFG file.
- The controller stopped working when an add-in adapter was installed.
- Make sure the cable is connected to the port from the onboard network controller.
- Make sure your BIOS is current. See [“Additional Information and Software”](#) for a link to the current version.
- Make sure the other adapter supports shared interrupts. Make sure your operating system supports shared interrupts.
- Try reseating the add-in adapter.

The add-in adapter stopped working without apparent cause

- Reseat the adapter.
- Put the adapter in a different slot.
- The network driver files may be corrupt or deleted. Delete and then reinstall the drivers.
- Run diagnostics.

System Boots when Installing PCI Card

System Server Management features require full-time "standby" power. This means some parts of the system have power going to them whenever the power cord is plugged in, even if you have turned the system power off with the power button on the front panel. If you install a PCI card with the AC power cord plugged in, a signal may be sent to command the system to boot. Before installing a PCI card, you should always:

- Turn off the server power by using the power button on the front of the system.
- Unplug the AC power cord(s) from the server.

Problems with Newly Installed Application Software

Problems that occur when you run new application software are usually related to the software, not the server hardware. Faulty equipment is unlikely, especially if other software runs correctly.

Check the following:

- Make sure the system meets the minimum hardware requirements for the software. See the software documentation.
- Make sure the software is properly installed and configured for the system. See the software documentation.

- Use only an authorized copy. Unauthorized copies often do not work.
- If you are running the software from a CD-ROM or DVD-ROM, try a different disk.
- Make sure the correct device drivers installed.

If the problems persist, contact the software vendor's customer service representative.

Problems with Application Software that Ran Correctly Earlier

Problems that occur after the system hardware and software have been running correctly sometimes indicate equipment failure. However, they can also be caused by file corruption or changes to the software configuration.

Check the following:

- If you are running the software from a CD-ROM or DVD-ROM, try a different disk.
- Check your system for a virus infection.
- Uninstall and reinstall the software. Make sure all necessary files are installed.
- If the problems are intermittent, there may be a loose cable, dirt in the keyboard (if keyboard input is incorrect), a marginal power supply, or other random component failures.
- If you suspect that a transient voltage spike, power outage, or brownout might have occurred, reload the software and try running it again. Symptoms of voltage spikes include a flickering video display, unexpected system reboots, and the system not responding to user commands.

***Note:** Random errors in data files: If you are getting random errors in your data files, they may be getting corrupted by voltage spikes on your power line. If you are experiencing any of the above symptoms that might indicate voltage spikes on the power line, you may want to install a surge suppressor between the power outlet and the system power cord.*

Devices are not Recognized under Device Manager (Windows* Operating System)

The Windows* operating systems do not include all of the drivers for the Intel® chipsets, onboard NICs, and other components. See [“Additional Information and Software”](#) for a link to the current drivers and chipset files.

Hard Drive(s) are not Recognized

Check the following:

- Make sure the drive is not disabled in BIOS Setup.
- Make sure the drive is connected correctly and that is plugged into the power supply.

- Make sure the drive is compatible. See [“Additional Information and Software”](#) for a link to the tested drives.
- Make sure you have not exceeded the power budget for the server. See [“Additional Information and Software”](#) for a link to software to check your power budget.
- If using SCSI drives, verify that each SCSI ID number is unique on the SCSI bus. See your drive documentation for details on setting the SCSI ID for your drives.
- If using ATA drives, verify that the master/slave settings are set correctly. See your drive documentation for details on setting the master/slave settings.
- If using a RAID configuration with SCSI or SATA drives, make sure the RAID card is installed correctly.

Bootable CD-ROM Disk Is Not Detected

Check the following:

- Make sure the BIOS is configured to allow the CD-ROM to be the first bootable device.

LED Information

The Intel® Server Board S3000AH includes LEDs that can aid in troubleshooting your system. A table of these LEDs with a description of their use is listed below.

Table 7. LED Information

LED Name	Function	Location	LED Color	Notes
Power	Indicates system power is on or off	Front control panel	Green	Off = Power is off or in sleep state S5 On = Power is on or in sleep state S0
ID	Aid in server identification from the back panel	Front control panel and board rear left corner	Blue	Press ID LED button or use Server Management software to turn the LED on and off.
System Fault	Visible fault warning	Control panel and board rear left corner	Green or Amber	Green = No Fault Green blinking = degraded condition Amber blinking = non-critical error Amber = critical or non-recoverable error

BIOS POST Beep Codes

The table below lists the POST error beep codes. Prior to system video initialization, the BIOS uses these beep codes to inform users of error conditions. Please note that not all error conditions are supported by BIOS beep codes.

Table 8. POST Error Beep Codes

Number of Beeps	Reason for Beeps and Action to Take
1, 2, or 3	Memory error. Reseat the memory or replace the DIMMs with known good modules.
4 - 7 or 9 - 11	Fatal error indicating a possible serious system problem. Remove all add-in cards and re-start the system. If the error still occurs, contact your system manufacturer. If the beep codes are not generated after the add-in cards are removed, insert the cards one at a time, booting the system between each card addition, until the beeps again occur to reveal the malfunctioning card.
8	Replace or reseat the system video add-in card. If on-board video is being used, the server board may be faulty.

Appendix D: Intel[®] Server Issue Report Form

Note: An on-line / automatic submission version of this form is available at <http://support.intel.com/support/motherboards/server/S3000AH/>. For the fastest service, please submit your form via the Internet.

Date Submitted: _____

Company Name: _____

Contact Name: _____

Email Address: _____

Intel Server Product: _____

Priority (Critical, Hot, High, Low): _____

Brief Problem Description. Provide a brief description below. See the last page for space to include a detailed problem description.

Board / Chassis Information

Baseboard Revision - PBA#: _____

Baseboard Serial Number: _____

Chassis Model: _____

CPU1 Speed/Stepping/Spec: _____

System BIOS Version: _____

HSC Firmware Version: _____

DIMM Configuration

DIMM 1A MB and Vendor / part number: _____

DIMM 1B MB and Vendor / part number: _____

DIMM 2A MB and Vendor / part number: _____

DIMM 2B MB and Vendor / part number: _____

Operating System Information

Operating System: _____

Version: _____

Service Pack: _____

Add-in Card, Peripheral, Video, NIC

Check each box below as applicable, and provide the requested information.

Peripheral Card or Peripheral Description Driver Revision IRQ # I/O Base Address NIC

Peripheral	Description	Driver Revision	IRQ	I/O Base Address	FW Revision
PCI 32/33					
PCI Slot 1					
PCI Slot 2					
PCIe* x4					
PCI Slot 3					
PCIe* x8					
PCI Slot 4					
PCI-X* 64/100					
PCI Slot 5					
Intel® Adaptive Slot/PCIe* x8					
PCI Slot 6					
Video					
On-board Video					
Add-in Video					

