

Intel[®] Server Board S5000PAL User's Guide

**A Guide for Technically Qualified Assemblers of Intel[®] Identified Subassemblies/
Products**

Intel Order Number D31968-004

Disclaimer

Information in this document is provided in connection with Intel® products. No license, express or implied, by estoppel or otherwise, to any intellectual property rights is granted by this document. Except as provided in Intel's Terms and Conditions of Sale for such products, Intel assumes no liability whatsoever, and Intel disclaims any express or implied warranty, relating to sale and/or use of Intel products including liability or warranties relating to fitness for a particular purpose, merchantability, or infringement of any patent, copyright or other intellectual property right. Intel products are not designed, intended or authorized for use in any medical, life saving, or life sustaining applications or for any other application in which the failure of the Intel product could create a situation where personal injury or death may occur. Intel may make changes to specifications and product descriptions at any time, without notice.

Intel server boards contain a number of high-density VLSI and power delivery components that need adequate airflow for cooling. Intel's own chassis are designed and tested to meet the intended thermal requirements of these components when the fully integrated system is used together. It is the responsibility of the system integrator that chooses not to use Intel developed server building blocks to consult vendor datasheets and operating parameters to determine the amount of airflow required for their specific application and environmental conditions. Intel Corporation can not be held responsible if components fail or the server board does not operate correctly when used outside any of their published operating or non-operating limits.

Intel, Intel Pentium, and Intel Xeon are trademarks or registered trademarks of Intel Corporation or its subsidiaries in the United States and other countries.

* Other names and brands may be claimed as the property of others.

Copyright © 2010, Intel Corporation. All Rights Reserved

Safety Information

Important Safety Instructions

Read all caution and safety statements in this document before performing any of the instructions. See also Intel Server Boards and Server Chassis Safety Information on the *Intel® Server Deployment Toolkit 2.0 CD* and/or at <http://support.intel.com/support/motherboards/server/sb/cs-010770.htm>.

Wichtige Sicherheitshinweise

Lesen Sie zunächst sämtliche Warnund Sicherheitshinweise in diesem Dokument, bevor Sie eine der Anweisungen ausführen. Beachten Sie hierzu auch die Sicherheitshinweise zu Intel-Serverplatinen und Servergehäusen auf der *Intel® Server Deployment Toolkit 2.0 CD* oder unter <http://support.intel.com/support/motherboards/server/sb/cs-010770.htm>.

Consignes de sécurité

Lisez attention toutes les consignes de sécurité et les mises en garde indiquées dans ce document avant de suivre toute instruction. Consultez Intel Server Boards and Server Chassis Safety Information sur le *Intel® Server Deployment Toolkit 2.0 CD* ou bien rendez-vous sur le site <http://support.intel.com/support/motherboards/server/sb/cs-010770.htm>.

Instrucciones de seguridad importantes

Lea todas las declaraciones de seguridad y precaución de este documento antes de realizar cualquiera de las instrucciones. Vea Intel Server Boards and Server Chassis Safety Information en el *Intel® Server Deployment Toolkit 2.0 CD* y/o en <http://support.intel.com/support/motherboards/server/sb/cs-010770.htm>.

重要安全指导

在执行任何指令之前，请阅读本文档中的所有注意事项及安全声明。和/或 <http://support.intel.com/support/motherboards/server/sb/CS-010770.htm> 上的 *Intel Server Boards and Server Chassis Safety Information* (《Intel 服务器主板与服务器机箱安全信息》)。

Warnings

Heed safety instructions: Before working with your server product, whether you are using this guide or any other resource as a reference, pay close attention to the safety instructions. You must adhere to the assembly instructions in this guide to ensure and maintain compliance with existing product certifications and approvals. Use only the described, regulated components specified in this guide. Use of other products / components will void the UL listing and other regulatory approvals of the product and will most likely result in noncompliance with product regulations in the region(s) in which the product is sold.

System power on/off: The power button DOES NOT turn off the system AC power. To remove power from system, you must unplug the AC power cord from the wall outlet. Make sure the AC power cord is unplugged before you open the chassis, add, or remove any components.

Hazardous conditions, devices and cables: Hazardous electrical conditions may be present on power, telephone, and communication cables. Turn off the server and disconnect the power cord, telecommunications systems, networks, and modems attached to the server before opening it. Otherwise, personal injury or equipment damage can result.

Electrostatic discharge (ESD) and ESD protection: ESD can damage disk drives, boards, and other parts. We recommend that you perform all procedures in this chapter only at an ESD workstation. If one is not available, provide some ESD protection by wearing an antistatic wrist strap attached to chassis ground any unpainted metal surface on your server when handling parts.

ESD and handling boards: Always handle boards carefully. They can be extremely sensitive to ESD. Hold boards only by their edges. After removing a board from its protective wrapper or from the server, place the board component side up on a grounded, static free surface. Use a conductive foam pad if available but not the board wrapper. Do not slide board over any surface.

Installing or removing jumpers: A jumper is a small plastic encased conductor that slips over two jumper pins. Some jumpers have a small tab on top that you can grip with your fingertips or with a pair of fine needle nosed pliers. If your jumpers do not have such a tab, take care when using needle nosed pliers to remove or install a jumper; grip the narrow sides of the jumper with the pliers, never the wide sides. Gripping the wide sides can damage the contacts inside the jumper, causing intermittent problems with the function controlled by that jumper. Take care to grip with, but not squeeze, the pliers or other tool you use to remove a jumper, or you may bend or break the pins on the board.

Preface

About this Manual

Thank you for purchasing and using the Intel® Server Board S5000PAL.

This manual is written for system technicians who are responsible for troubleshooting, upgrading, and repairing this server board. This document provides a brief overview of the features of the board/chassis, a list of accessories or other components you may need, troubleshooting information, and instructions on how to add and replace components on the Intel® Server Board S5000PAL. For the latest version of this manual, see <http://support.intel.com/support/motherboards/server/S5000PAL/>.

Manual Organization

Chapter 1 provides a brief overview of the Intel® Server Board S5000PAL. In this chapter, you will find a list of the server board features, photos of the product, and product diagrams to help you identify components and their locations.

Chapter 2 provides instructions on using the utilities that are shipped with the board or that may be required to update the system. This includes how to navigate through the BIOS Setup screens, how to perform a BIOS update, and how to reset the password or CMOS. Information about the specific BIOS settings and screens is available in the Intel® 5000 Series Chipsets Server Board Family Datasheet. See "[Additional Information and Software](#)" for a link to the Intel® 5000 Series Chipsets Server Board Family Datasheet.

Chapter 3 provides instructions on adding and replacing components. Use this chapter for step-by-step instructions and diagrams for installing or replacing components such as the memory, processor, control panel board, and the battery, among other components.

Chapter 4 provides troubleshooting information. In this chapter, you will find BIOS error messages and POST code messages. You will also find suggestions for performing troubleshooting activities to identify the source of a problem.

Product Accessories

This server board is compatible with the following Intel® Server Chassis:

- Intel® Server Chassis SR1500
- Intel® Server Chassis SR1550
- Intel® Server Chassis SR2500

You may need or want to purchase one or more of the following accessory items for your server:

Processor(s), memory DIMMs, hard drive, USB floppy drive, CD-ROM or DVD-ROM drive, RAID controller, operating system.

For information about which accessories, memory, processors, and third-party hardware have been tested and can be used with your board, and for ordering information for Intel products, see <http://support.intel.com/support/motherboards/server/S5000PAL/compat.htm>.

Additional Information and Software

If you need more information about this product or information about the accessories that can be used with this server board, use the following resources. These files are available at <http://support.intel.com/support/motherboards/server/S5000PAL/>

Unless otherwise indicated in the table below, once on this Web page, type the document or software name in the search field at the left side of the screen and select the option to search "This Product."

Table 1. Additional Information and Software

For this information or software	Use this Document or Software
For in-depth technical information about this product	<i>Intel® Server Board S5000PAL Technical Product Specification</i>
For BIOS settings and chipset information	<i>Intel® 5000 Series Chipsets Server Board Family Datasheet</i>
If you just received this product and need to install it	Intel® Server Board S5000PAL <i>Quick Start User's Guide</i> in the product box
For virtual system tours and interactive repair information	A link to the SMaRT Tool is available under "Other Resources" at the right side of the screen at http://support.intel.com/support/motherboards/server/S5000PAL

Table 1. Additional Information and Software

For this information or software	Use this Document or Software
Accessories or other Intel server products	Spares and Configuration Guide
Hardware (peripheral boards, adapter cards) and operating systems that have been tested with this product	Tested Hardware Operating Systems List
Chassis that have been tested with this product	Reference Chassis List
Processors that have been tested with this product	Supported Processors
DIMMs that have been tested with this product	Tested Memory List
To make sure your system falls within the allowed power budget	Power Budget Tool
For software to manage your Intel® system	Intel® System Management Software
For drivers	Driver (for an extensive list of available drivers) Operating System Driver (for operating system drivers)
For firmware and BIOS updates, or for BIOS recovery	Firmware Updates
For diagnostics test software	Diagnostics

See also the *Intel® Server Deployment Toolkit 2.0 CD* that came with your server board.

Contents

Safety Information	iii
Important Safety Instructions	iii
Wichtige Sicherheitshinweise	iii
Consignes de sécurité	iii
Instrucciones de seguridad importantes	iii
Warnings	v
Preface	vii
About this Manual	vii
Manual Organization	vii
Product Accessories	viii
Additional Information and Software	viii
Chapter 2: Server Board Features	1
Connector and Component Locations	3
Configuration Jumpers	5
Intel® Light Guided Diagnostics	7
Back Panel Connectors	8
RAID Support	9
Hardware Requirements	10
Processor	10
Memory	11
Power Supply	13
Optional Hardware	13
Intel® RAID Activation Key	13
Hard Disk Drives	13
Intel® Remote Management Module and RMM NIC	13
Intel® Local Control Panel	14
Chapter 3: Server Utilities	15
Using the BIOS Setup Utility	15
Starting Setup	15
If You Cannot Access Setup	15
Setup Menus	15
Upgrading the BIOS	17
Preparing for the Upgrade	17
Upgrading the BIOS	18
Clearing the Password	18
Clearing the CMOS	19
Chapter 4: Hardware Installations and Upgrades	21

Before You Begin	21
Tools and Supplies Needed	21
Installing and Removing Memory	21
Installing DIMMs	21
Removing DIMMs	23
Installing the Processor	24
Installing the Heat Sink(s)	26
Removing a Processor	27
Replacing the Backup Battery	28
Appendix A: Getting Help	31
World Wide Web	31
Telephone	31
Appendix B: Regulatory and Compliance Information	35
Product Regulatory Compliance	35
Product Safety Compliance	35
Certifications / Registrations / Declarations	36
Product Regulatory Compliance Markings	36
Electromagnetic Compatibility Notices	37
FCC (USA)	37
Industry Canada (ICES-003)	38
Europe (CE Declaration of Conformity)	38
Taiwan Declaration of Conformity (BSMI)	38
Korean Compliance (RRL)	39
Restriction of Hazardous Substances (RoHS) Compliance	40
End-of-Life / Product Recycling	40
Appendix C: Troubleshooting	41
Resetting the System	41
Problems following Initial System Installation	42
First Steps Checklist	42
Hardware Diagnostic Testing	43
Verifying Proper Operation of Key System Lights	43
Confirming Loading of the Operating System	43
Specific Problems and Corrective Actions	44
Power Light Does Not Light	44
No Characters Appear on Screen	45
Characters Are Distorted or Incorrect	45
System Cooling Fans Do Not Rotate Properly	46
Drive Activity Light Does Not Light	46
CD-ROM Drive or DVD-ROM Drive Activity Light Does Not Light	46
Cannot Connect to a Server	47
Problems with Network	47

System Boots when Installing PCI Card	48
Problems with Newly Installed Application Software	48
Problems with Application Software that Ran Correctly Earlier	48
Devices are not Recognized under Device Manager (Microsoft* Windows* Operating System)	49
Hard Drive(s) are not Recognized	49
Bootable CD-ROM Disk Is Not Detected	49
LED Information	50
BIOS POST Beep Codes	50
Appendix D: LED Decoder	53
Appendix E: Intel® Server Issue Report Form	59

List of Tables

Table 1. Additional Information and Software	viii
Table 2. Server Board Features	2
Table 3. NIC LED Descriptions	9
Table 4. Setup Menu Key Use	16
Table 5. Product Certification Markings	36
Table 6. Resetting the System	41
Table 7. LED Information	50
Table 8. POST Error Beep Codes	50
Table 9. Error Beep Codes Generated by Intel® Remote Management Module	51
Table 10. POST Progress Code LED Example	53
Table 11. Diagnostic LED POST Code Decoder	54

List of Figures

Figure 1. Intel® Server Board S5000PAL	1
Figure 2. Server Board Connector and Component Locations	4
Figure 3. BIOS Select Jumper.....	5
Figure 4. Recovery Jumpers	6
Figure 5. Light Guided Diagnostic LEDs	7
Figure 6. Back Panel Connectors.....	8
Figure 7. DIMM Configuration Diagram.....	11
Figure 8. Four DIMM Configuration Example	12
Figure 9. Clear Password Jumper.....	19
Figure 10. Clear CMOS Jumper.....	20
Figure 11. Installing the Memory	22
Figure 12. Lifting the Processor Socket Handle	24
Figure 13. Installing the Processor.....	24
Figure 14. Removing the Socket Cover	25
Figure 15. Installing the Heat Sink	26
Figure 16. Replacing the Backup Battery.....	29
Figure 17. Diagnostic LED Placement Diagram.....	54

2 Server Board Features

This chapter briefly describes the main features of the Intel® Server Board S5000PAL. This chapter provides a photograph of the product, a list of the server board features, and diagrams showing the location of important components and connections on the server board.

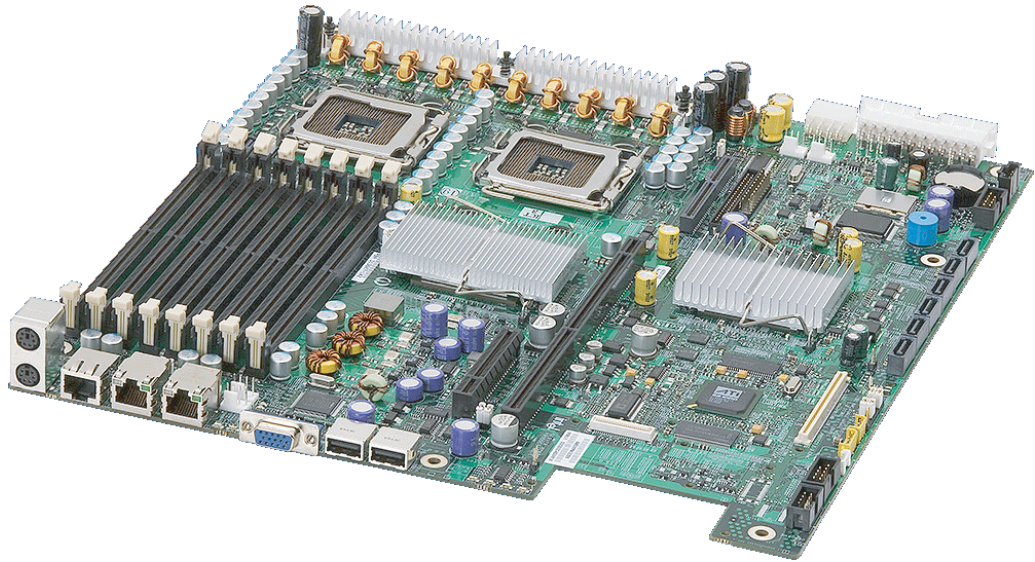

Figure 1. Intel® Server Board S5000PAL

Table 2 summarizes the features of the server board.

Table 2. Server Board Features

Feature	Description
Processor	<p>Support for up to two Dual-Core Intel® Xeon® processors 5000 or 5100 sequence with a 677-, 1066-, or 1333-MHz front side bus.</p> <p>Up to two Quad-Core Intel® Xeon® processors 5300 sequence with a 1066- or 1333-MHz front side bus.</p> <p>Up to two 45nm 2P Dual-Core Intel® Xeon® processors. Product codes S5000PALR and S5000XALR only.</p> <p>Up to two 45nm next generation Quad-Core Intel® Xeon® processors. Product codes S5000PALR and S5000XALR only.</p>
Memory	<ul style="list-style-type: none"> • Eight DIMM slots supporting stacked DDR2 533/667 MHz FBDIMM memory • Support for up to 32 GB DDR2 533/667 MHz FBDIMM memory
Chipset	<p>Intel® 5000P or Intel® 5000X chipset, consisting of:</p> <ul style="list-style-type: none"> • Intel® 5000P or Intel® 5000X Memory Controller Hub (MCH) • Intel® 6321ESB I/O Controller Hub
Peripheral Interfaces	<p>External connections:</p> <ul style="list-style-type: none"> • Stacked PS/2* ports for keyboard and mouse • RJ45 Serial B port • Two RJ45 NIC connectors for 10/100/1000 Mb connections • Two USB 2.0 ports <p>Internal connections:</p> <ul style="list-style-type: none"> • One USB port header, which supports two USB 2.0 ports • One DH10 Serial A header • Six Serial ATA 150 connectors with integrated RAID 0/1 support • One ATA-100 44-pin connector for optical drive support • SSI-compliant 24-pin control panel header • SSI-compliant 24-pin main power connector, supporting the ATX-12V standard on the first 20 pins
I/O Controll	National Semiconductor* PC87427 controller
Video	On-board ATI* ES1000 video controller with 16 MB DDR SDRAM
Hard drive	<ul style="list-style-type: none"> • Support for six SATA-150 hard drives
LAN	Intel® 82563EB dual port controller for 10/100/1000 Mbit/sec Ethernet LAN connectivity
Expansion Capabilities	<ul style="list-style-type: none"> • One low profile riser slot supporting 1U or 2U PCI Express* riser cards • One full height riser slot supporting 1U or 2U PCI-X* and PCI Express* riser cards
Fans	Support for two processor fans and four system fans

Table 2. Server Board Features

Feature	Description
Server Management	Intel® System Management Software

Connector and Component Locations

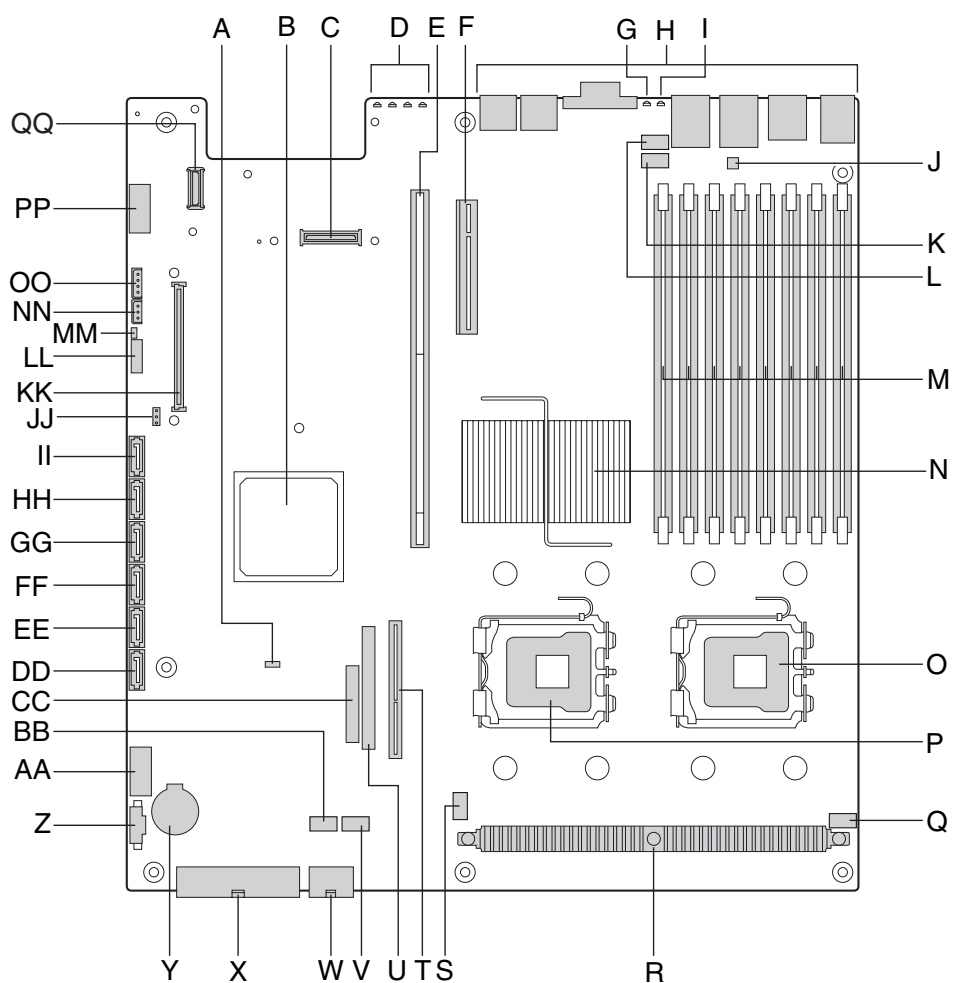

TP02071

A. BIOS Bank Select Jumper	B. Intel® 6321ESB IO Controller Hub	C. I/O Expansion Module Connector
D. POST Code Diagnostic LEDs	E. Intel® Adaptive Slot - Full Height	F. PCI Express* Riser Slot - Low Profile
G. System Identification LED - Blue	H. Back Panel I/O Ports	I. Status LED - Green/Amber
J. Serial B Configuration Jumper	K. System Fan 4 Header	L. System Fan 3Header
M. DIMM Sockets	N. Intel® 5000P MCH or Intel® 5000X MCH	O. Processor 1 Socket
P. Processor 2 Socket	Q. Processor Fan 1 Header	R. Voltage Regulator Heat Sink
S. Processor Fan 2 Header	T. Bridge Board Connector	U. ATA-100 Optical Drive Connector (Power + IO)
V. System Fan 2 Header	W. CPU Power Connector	X. Main Power Connector
Y. Battery	Z. Power Supply Management Connector	AA. Dual Port USB 2.0 Header
BB. System Fan 1 Header	CC. 24-pin SSI Control Panel Connector	DD. SATA Port 0
EE. SATA Port 1	FF. SATA Port 2	GG. SATA Port 3
HH. SATA Port 4	II. SATA Port 5	JJ. SATA SW RAID 5 Activation Key Connector
KK. Intel® Remote Management Module (RMM) Connector	LL. System Recovery Jumpers	MM. Chassis Intrusion Switch Header
NN. 3-pin IPMB Header	OO. Intel® Local Control Panel Header	PP. Serial A Header
QQ. Intel® RMM NIC Connector		

Figure 2. Server Board Connector and Component Locations

Configuration Jumpers

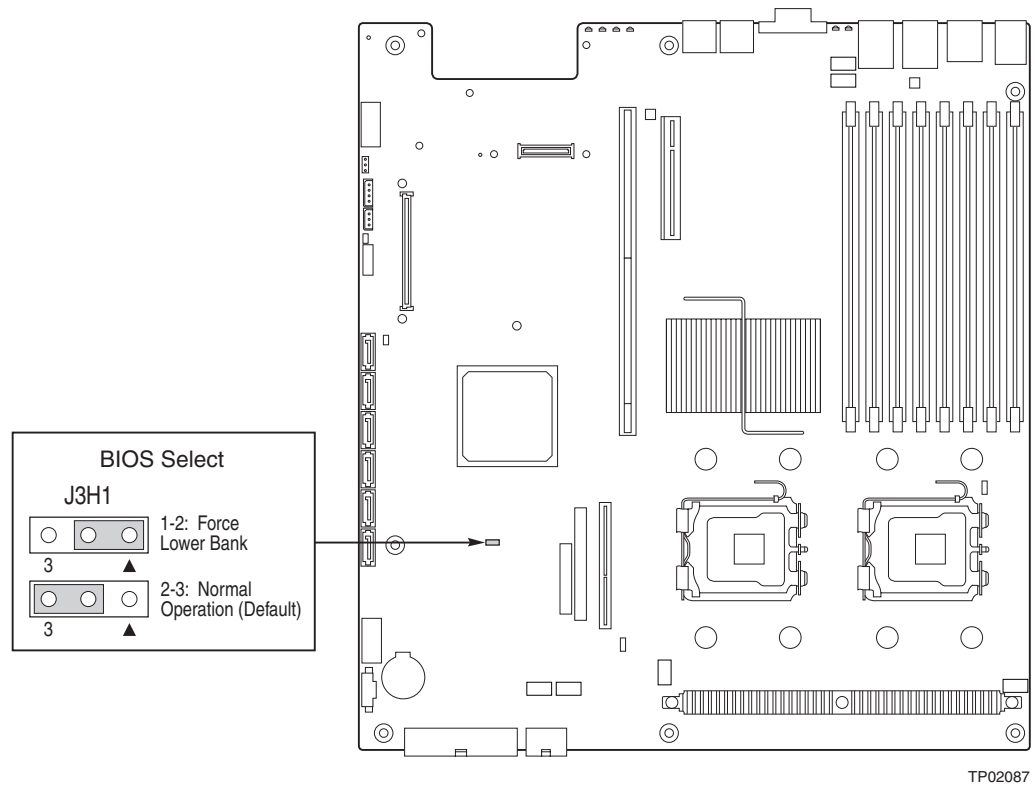

Jumper Name	Jumper Purpose
BIOS Select	If pins 1-2 are jumpered, the BIOS in the lower bank will be selected on the next reset. These pins should be jumpered on 2-3 for normal operation.

Figure 3. BIOS Select Jumper

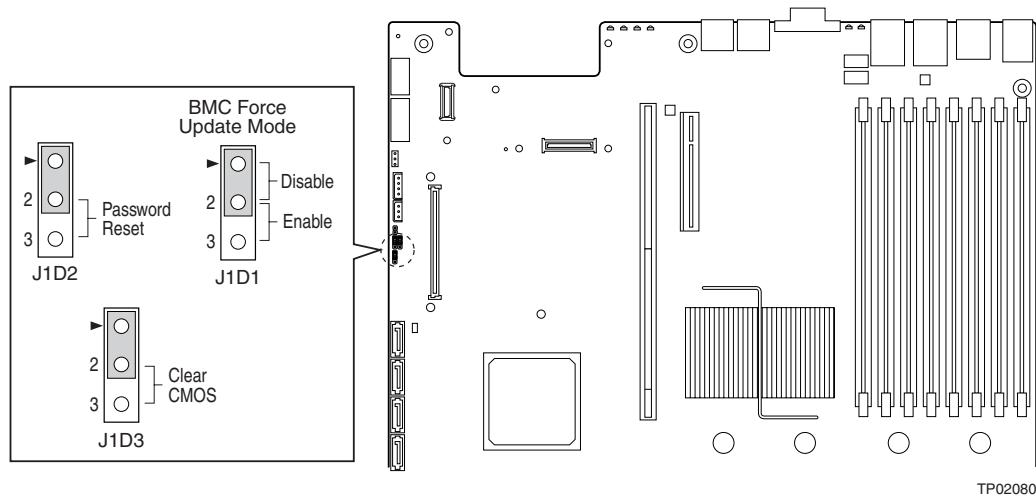

Jumper Name	Jumper Purpose
CMOS Clear	If pins 2-3 are jumpered, the CMOS settings will be cleared on the next reset. These pins should be jumpered on 1-2 for normal operation.
Password Clear	If pins 2-3 are jumpered, administrator and user passwords will be cleared on the next reset. These pins should be jumpered on 1-2 for normal operation.
BMC Force Update Mode	If pins 2-3 are jumpered, BMC Force Update Mode is enabled. These pins should be jumpered on 1-2 for normal operation.

Figure 4. Recovery Jumpers

Intel® Light Guided Diagnostics

The server board contains diagnostic LEDs to help you identify failed and failing components, and to help you identify the server from among several servers. Except for the ID LED, the status LED, and the 5V standby LED, the LEDs turn on (amber) only if a failure occurs.

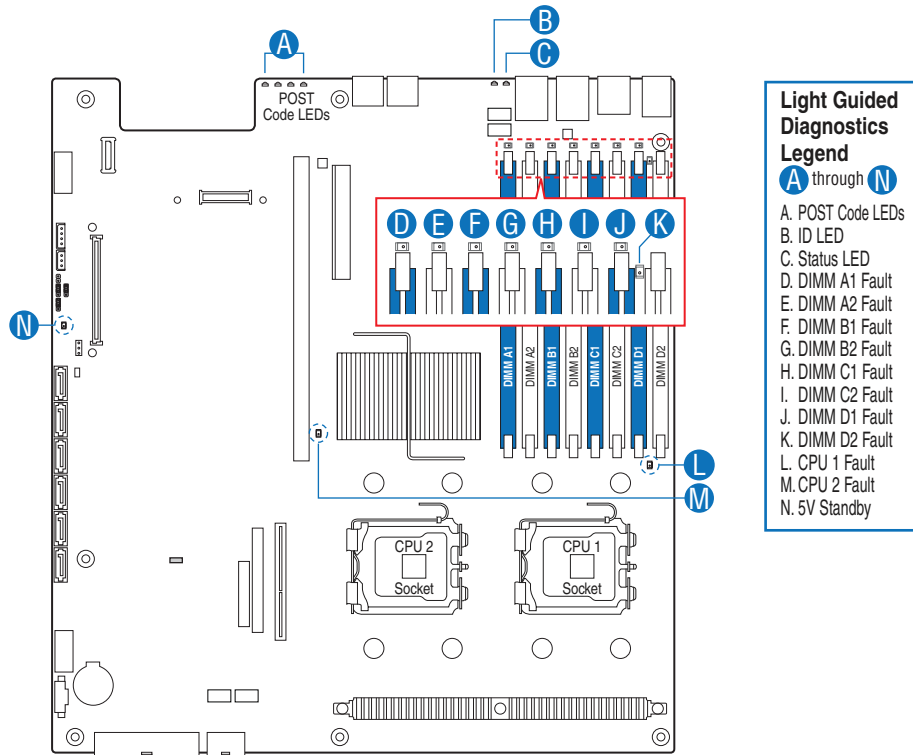

AF000644

Figure 5. Light Guided Diagnostic LEDs

Back Panel Connectors

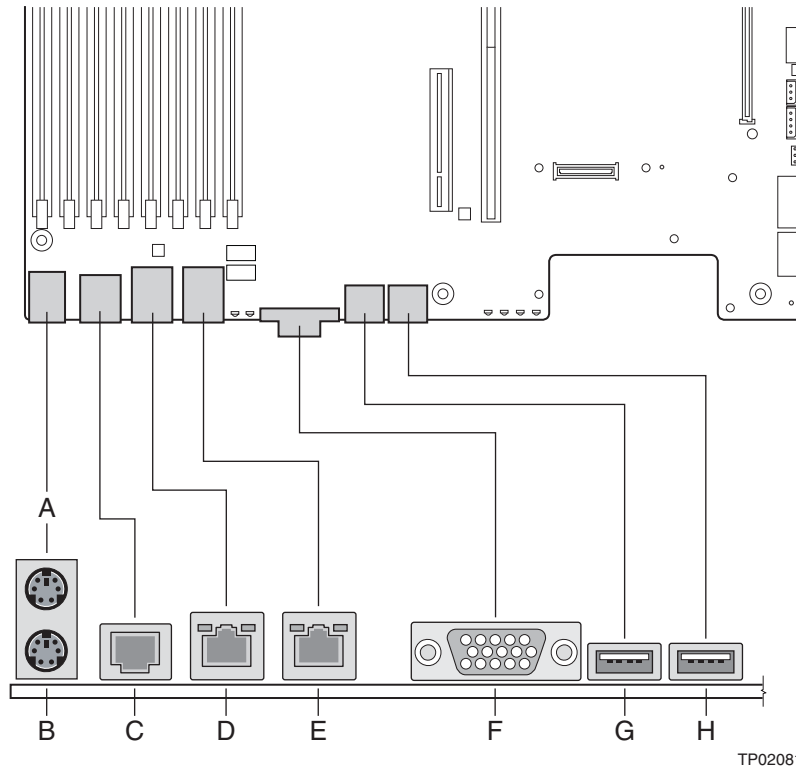

A. Mouse	B. Keyboard
C. Serial Port B	D. NIC 1 (10/100/1000 Mb)
E. NIC 2 (10/100/1000 Mb)	F. Video
G. USB Port 6	H. USB Port 5

Figure 6. Back Panel Connectors

The NIC LEDs at the right and left of each NIC provide the following information.

Table 3. NIC LED Descriptions

LED	LED State	Description
Left	Off	No network connection
	Solid Amber	Network connection in place
	Blinking Amber	Transmit/receive activity
Right	Off	10 Mbps connection (if left LED is on or blinking)
	Solid Amber	100 Mbps connection
	Solid Green	1000 Mbps connection

RAID Support

The Intel® Server Board S5000PAL provides an embedded SATA controller that supports both 1.5 and 3.0 Gbps data transfer rates.

The BIOS Setup utility provides multiple drive configuration options on the Advanced | ATA Controller setup page, some of which affect the ability to configure RAID. The “Onboard SATA Controller” option is enabled by default. When this option is enabled, the “SATA Mode” option can be set to either Legacy or Enhanced. The Legacy and Enhanced modes affect the RAID configuration as follows:

- Legacy supports four disk drives and does not provide RAID support.
- Enhanced supports six disk drives and is required for RAID configurations.

When the enhanced mode is selected, you can choose to enable or disable “AHCI Mode” or “Configure SATA as RAID”. Intel® Embedded Server RAID Technology II is enabled by the option, “Configure SATA as RAID.” The Intel® Embedded Server RAID Technology II feature provides RAID modes 0, 1, and 10.

For RAID 0, 1, and 10, enclosure management is provided through the SATA_SGPIO connector on the server board when a cable is attached between this connector on the server board and to the backplane or I²C interface.

If RAID 5 is desired, the optional Intel® RAID Activation Key AXXRAKSW5 can be installed. To enable RAID 5, this activation key is placed on the SATA Key connector that is located at the left side of the server board. For information on how to install the Intel® RAID Activation Key AXXRAKSW5 accessory to enable RAID 5, see the documentation that is included with the accessory kit.

For information on configuring RAID, see the RAID software user’s guide that is included on the *Intel® Server Deployment Toolkit 2.0 CD*.

Hardware Requirements

To avoid integration difficulties and possible board damage, your system must meet the requirements outlined below. For a list of qualified components, see the links under ["Additional Information and Software."](#)

Processor

Support for one or two Dual-Core Intel® Xeon® processors 5000 or 5100 sequence with a 677-, 1066-, or 1333-MHz front side bus.

Up to two Quad-Core Intel® Xeon® processors 5300 sequence with a 1066- or 1333-MHz front side bus.

Up to two 45nm 2P Dual-Core Intel® Xeon® processors. Product codes S5000PALR and S5000XALR only.

Up to two 45nm next generation Quad-Core Intel® Xeon® processors. Product codes S5000PALR and S5000XALR only.

For a complete list of supported processors, see the links under ["Additional Information and Software."](#)

Memory

The server board provides eight DIMM sockets across two branches, and each branch has two channels. Channel A consists of slots A1 and A2; channel B consists of slots B1 and B2; channel C consists of slots C1 and C2; and channel D consists of slots D1 and D2.

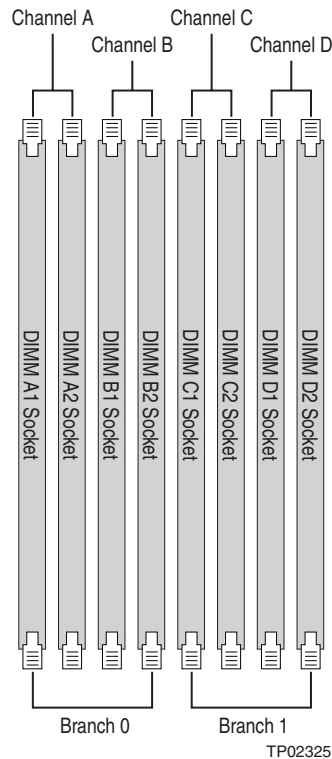

Figure 7. DIMM Configuration Diagram

DIMMs must be populated in pairs across consecutive channels starting with the lowest numbered slot in each channel. Slots A1 and B1 are paired, followed by slots C1 and D1. For performance reasons, when configuring four DIMMs, DIMM pairs A2 and B2 should never be populated before DIMM pair C1 and D1. A four DIMM configuration should be populated as A1 and B1; C1 and D1. See [Figure 8](#) for a four DIMM configuration example.



Figure 8. Four DIMM Configuration Example

In non-mirrored mode, all DIMMs with the same slot number within a given branch must match (size, technology, manufacturer). It is not required to match DIMMs between different slot numbers.

DIMMs must meet the following requirements:

- Use only Fully Buffered DIMMs (FBD) with DDR2 DRAM technology.
- Use only FBD DDR2-533 and FBD DDR2-667 stacked DIMM modules.

In determining your memory requirements, the need for memory sparing or memory mirroring must be considered. For a complete list of supported memory DIMMs, see the links under "[Additional Information and Software.](#)"

Memory Sparing and Mirroring

The chipset includes hardware that supports memory mirroring and memory on-line sparing. Both memory mirroring and memory on-line sparing provide a way to prevent data loss in case a DIMM fails.

With memory mirroring the system maintains two copies of all data in the memory subsystem. If a DIMM fails, the data is not lost because the second copy of the data is available from the mirrored DIMM in the opposite channel. The system will not fail due to memory error unless both the primary and the mirrored copy of the data become corrupt at the same time.

In a mirrored system, the maximum usable memory is one-half of the installed memory, with a minimum of four DIMMs installed. Since the data is duplicated across DIMMs, it means that up to one-half of the installed DIMMs are actively in use at any one time. The remaining DIMMs are used for mirroring.

Memory mirroring and memory sparing are mutually exclusive. Only one can be active at a time. See the Intel® Server Board S5000PAL/S5000XAL *Technical Product Specification* for additional information regarding the memory sub-system.

Power Supply

A minimum of 550 Watts is required. Your supply must provide a minimum of 3.5A of 5V standby current or the server board will not boot.

Optional Hardware

Intel® RAID Activation Key

The Intel® RAID Activation Key AXXRAKSW5 can be purchased and installed to enable RAID 5 support on your server board. An Intel® RAID Activation Key can be installed in the SATA RAID 5 Key connector.

Installation instructions for the RAID Activation Key are included with the accessory.

Hard Disk Drives

The server board provides six SATA ports. The six SATA ports are near the rear left side of the server board.

See the documentation included with your server chassis for additional drive information and drive installation instructions.

Intel® Remote Management Module and RMM NIC

The Intel® Remote Management Module and the RMM NIC plug into connectors on the server board and act as components of the server board, not as separate products. These two components must be installed together.

These components provide a way to view and operate the server remotely, in real-time. Keyboard, video, and mouse control (KVM) is redirected to a managing system; this provides remote control of the server. USB media redirection allows you to use a USB device anywhere on the network as if it was installed on the managed server.

For installation instructions on installing the Intel® Remote Management Module, see the instructions provided with the module.

Intel® Local Control Panel

The Intel® Local Control Panel provides enhanced system control by utilizing a LCD display, which provides additional controls and indicators beyond the standard control panel.

3 Server Utilities

Using the BIOS Setup Utility

This section describes the BIOS Setup Utility options, which is used to change server configuration defaults. You can run BIOS Setup with or without an operating system being present. See [“Additional Information and Software”](#) for a link to the Intel® 5000 Series Chipsets Server Board Family Datasheet where you will find details about specific BIOS setup screens.

Starting Setup

You can enter and start BIOS Setup under several conditions:

- When you turn on the server, after POST completes the memory test.
- When you have moved the CMOS jumper on the server board to the "Clear CMOS" position (enabled).

In the two conditions listed above, during the Power On Self Test (POST), you will see this prompt:

```
Press <F2> to enter SETUP
```

In a third condition, when CMOS/NVRAM has been corrupted, you will see other prompts but not the <F2> prompt:

```
Warning: CMOS checksum invalid  
Warning: CMOS time and date not set
```

In this condition, the BIOS will load default values for CMOS and attempt to boot.

If You Cannot Access Setup

If you are not able to access BIOS Setup, you might need to clear the CMOS memory. For instructions on clearing the CMOS, see ["Clearing the CMOS"](#).

Setup Menus

Each BIOS Setup menu page contains a number of features. Except for those features that are provided only to display automatically configured information, each feature is associated with a value field that contains user-selectable parameters. These parameters can be changed if the user has adequate security rights. If a value cannot be changed for any reason, the feature's value field is inaccessible.

“Setup Menu Key Use” describes the keyboard commands you can use in the BIOS Setup menus.

Table 4. Setup Menu Key Use

Key to Press	Description
<F1>	Pressing <F1> on any menu invokes the general help window.
Left and right arrows	The left and right arrow keys are used to move between the major menu pages. The keys have no affect if a submenu or pick list is displayed.
Up arrow	Select Item up - The up arrow is used to select the previous value in a menu item's option list, or a value field pick list. Pressing the <Enter> key activates the selected item.
Down arrow	Select Item down - The down arrow is used to select the next value in a menu item's option list, or a value field pick list. Pressing the <Enter> key activates the selected item.
<F5> or <->	Change Value - The minus key or the <F5> function key is used to change the value of the current item to the previous value. This key scrolls through the values in the associated pick list without displaying the full list.
<F6> or <+>	Change Value - The plus key or the <F6> function key is used to change the value of the current menu item to the next value. This key scrolls through the values in the associated pick list without displaying the full list. On 106-key Japanese keyboards, the plus key has a different scan code than the plus key on the other keyboard, but it has the same effect.
<Enter>	Execute Command - The <Enter> key is used to activate submenus when the selected feature is a submenu, or to display a pick list if a selected feature has a value field, or to select a sub-field for multi-valued features like time and date. If a pick list is displayed, the <Enter> key will undo the pick list, and allow another selection in the parent menu.
<Esc>	Exit - The <Esc> key provides a mechanism for backing out of any field. This key will undo the pressing of the <Enter> key. When the <Esc> key is pressed while editing any field or selecting features of a menu, the parent menu is re-entered. When the <Esc> key is pressed in any submenu, the parent menu is re-entered. When the <Esc> key is pressed in any major menu, the exit confirmation window is displayed and the user is asked whether changes can be discarded.
<F9>	Setup Defaults - Pressing <F9> causes the following to appear: <pre style="margin-left: 40px;"> Setup Confirmation Load default configuration now? [Yes] [No] </pre> If "Yes" is selected and the <Enter> key is pressed, all Setup fields are set to their default values. If "No" is selected and the <Enter> key is pressed, or if the <Esc> key is pressed, the user is returned to where they were before <F9> was pressed without affecting any existing field values.

Table 4. Setup Menu Key Use

Key to Press	Description
<F10>	<p>Save and Exit - Pressing <F10> causes the following message to appear:</p> <pre> Setup Confirmation Save Configuration changes and exit now? [Yes] [No]</pre> <p>If "Yes" is selected and the <Enter> key is pressed, all changes are saved and Setup is exited. If "No" is selected and the <Enter> key is pressed, or the <Esc> key is pressed, the user is returned to where they were before <F10> was pressed without affecting any existing values.</p>

Upgrading the BIOS

The upgrade utility allows you to upgrade the BIOS in flash memory. The code and data in the upgrade file include the following:

- On-board system BIOS, including the recovery code, BIOS Setup Utility, and strings.
- On-board video BIOS, and other option ROMs for devices embedded on the server board.
- OEM binary area
- Microcode
- A way to change the BIOS language

Preparing for the Upgrade

The steps below explain how to prepare to upgrade the BIOS, including how to record the current BIOS settings and how to obtain the upgrade utility.

Note: *In the unlikely event that a BIOS error occurs during the BIOS update process, a recovery process may need to be followed to return the system to service. See “[Additional Information and Software](#)” for a link to necessary software and instructions.*

Recording the Current BIOS Settings

1. Boot the computer and press <F2> when you see the message:
Press <F2> Key if you want to run SETUP
2. Write down the current settings in the BIOS Setup program.

Note: *Do not skip step 2. You will need these settings to configure your computer at the end of the procedure.*

Obtaining the Upgrade

Download the BIOS image file to a temporary folder on your hard drive. See [“Additional Information and Software”](#) for a link to the update software.

Note: *Review the instructions and release notes that are provided in the readme file distributed with the BIOS image file before attempting a BIOS upgrade. The release notes contain critical information regarding jumper settings, specific fixes, or other information to complete the upgrade.*

Upgrading the BIOS

Follow the instructions in the readme file that came with the BIOS upgrade. When the update completes, remove the bootable media from which you performed the upgrade.

Caution: *Do not power down the system during the BIOS update process! The system will reset automatically when the BIOS update process is completed.*

Note: *You may encounter a CMOS Checksum error or other problem after reboot. If this happens, shut down the system and boot it again. CMOS checksum errors require that you enter Setup, check your settings, save your settings, and exit Setup.*

Clearing the Password

If the user or administrator password(s) is lost or forgotten, moving the password clear jumper into the "clear" position clears both passwords. The password clear jumper must be restored to its original position before a new password(s) can be set.

1. Power down the system and disconnect the AC power.
2. Open the server chassis.
3. Move the jumper from the normal operation position, Password Clear Protect, at pins 1 and 2 to the Password Clear Erase position, covering pins 2 and 3.

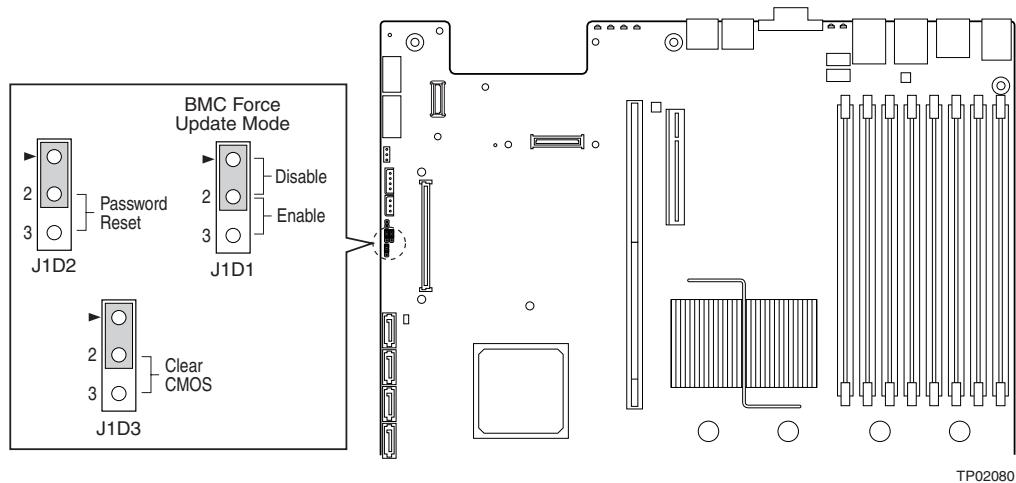

Figure 9. Clear Password Jumper

4. Wait five seconds.
5. Return the Password Clear jumper to the Password Clear Protect position, covering pins 1 and 2.
6. Close the server chassis.
7. Reconnect the AC power and power up the server.
8. The password is now cleared and can be reset by going into BIOS setup.

Clearing the CMOS

If you are not able to access the BIOS setup screens, the CMOS Clear jumper will need to be used to reset the configuration RAM.

1. Power down the system and disconnect the AC power.
2. Open the server.
3. Move the jumper from the normal operation position, CMOS Clear by BMC, at pins 1 and 2 to the CMOS Clear Force Erase position, covering pins 2 and 3.

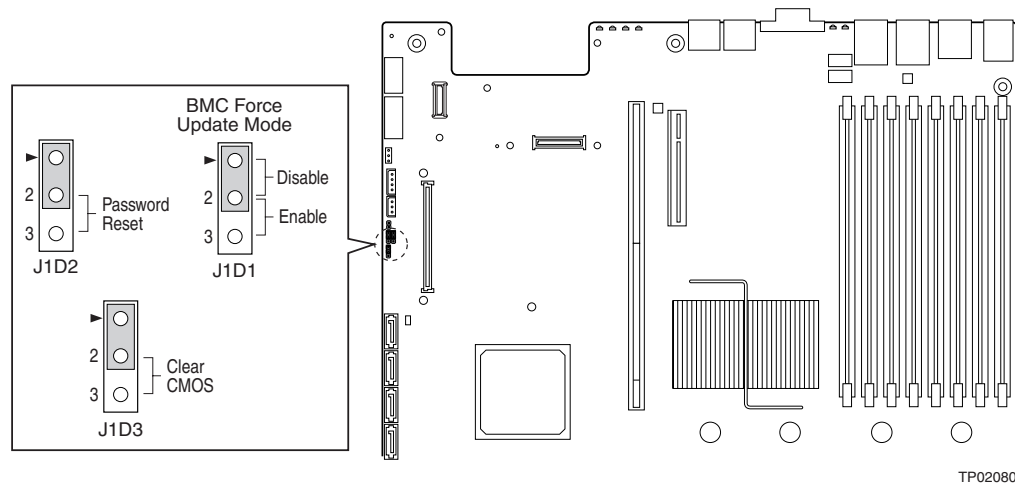

Figure 10. Clear CMOS Jumper

4. Wait five seconds.
5. Return the CMOS Clear jumper to the CMOS Clear by BMC location, covering pins 1 and 2.
6. Close the server chassis.
7. Reconnect the AC power and power up the system.
8. The CMOS is now cleared and can be reset by going into the BIOS setup.

4 Hardware Installations and Upgrades

Before You Begin

Before working with your server product, pay close attention to the “[Safety Information](#)” at the beginning of this manual.

Tools and Supplies Needed

- Phillips* (cross head) screwdriver (#1 bit and #2 bit)
- Needle nosed pliers
- Antistatic wrist strap and conductive foam pad (recommended)

Installing and Removing Memory

The silkscreen on the board for the DIMMs displays DIMM A1, DIMM A2, DIMM B1, DIMM B2, DIMM C1, DIMM C2, DIMM D1 and DIMM D2 starting from the center of the board. See "Memory" for a discussion of the memory requirements and options. See “[Additional Information and Software](#)” for a link to the list of tested DIMMs.

Installing DIMMs

To install DIMMs, follow these steps:

1. Observe the safety and ESD precautions in “[Safety Information](#)”.
2. Turn off all peripheral devices connected to the server. Turn off the server.
3. Disconnect the AC power cord from the server.
4. Remove the server's cover. See the documentation that came with your server chassis for instructions on removing the server's cover.
5. Locate the DIMM sockets (see [Figure 11](#)).

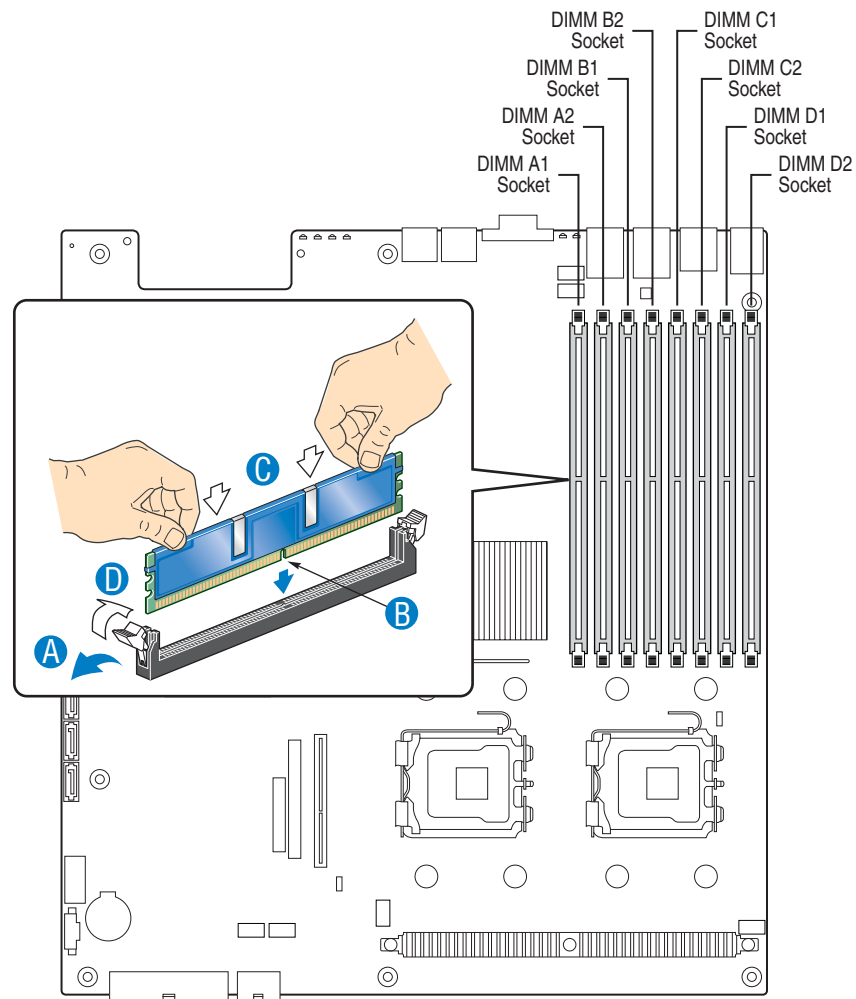

TP02072

Figure 11. Installing the Memory

6. Make sure the clips at either end of the DIMM socket(s) are pushed outward to the open position.
7. Holding the DIMM by the edges, remove it from its anti-static package.
8. Position the DIMM above the socket. Align the notch on the bottom edge of the DIMM with the key in the DIMM socket. The arrow in the inset in Figure 7 is pointing to the key in the socket.
9. Insert the bottom edge of the DIMM into the socket.
10. When the DIMM is inserted, push down on the top edge of the DIMM until the retaining clips snap into place. Make sure the clips are firmly in place.

11. Replace the server's cover and reconnect the AC power cord. See the documentation that came with your server chassis for instructions on installing the server's cover.

Removing DIMMs

To remove a DIMM, follow these steps:

1. Observe the safety and ESD precautions in [“Safety Information”](#).
2. Turn off all peripheral devices connected to the server. Turn off the server.
3. Remove the AC power cord from the server.
4. Remove the server's cover. See the documentation that came with your server chassis for instructions on removing the server's cover.
5. Gently spread the retaining clips at each end of the socket. The DIMM lifts from the socket.
6. Holding the DIMM by the edges, lift it from the socket, and store it in an anti-static package.
7. Reinstall and reconnect any parts you removed or disconnected to reach the DIMM sockets.
8. Replace the server's cover and reconnect the AC power cord. See the documentation that came with your server chassis for instructions on installing the server's cover.

Installing or Replacing the Processor

Caution: *Processor must be appropriate: You may damage the server board if you install a processor that is inappropriate for your server. See [“Additional Information and Software”](#) for a link to the list of compatible processor(s).*

Caution: *ESD and handling processors: Reduce the risk of electrostatic discharge (ESD) damage to the processor by doing the following: (1) Touch the metal chassis before touching the processor or server board. Keep part of your body in contact with the metal chassis to dissipate the static charge while handling the processor. (2) Avoid moving around unnecessarily.*

Installing the Processor

To install a processor, follow these instructions:

1. Observe the safety and ESD precautions in “[Safety Information](#)”.
2. Turn off all peripheral devices connected to the server. Turn off the server.
3. Disconnect the AC power cord from the server.
4. Remove the server's cover. See the documentation that came with your server chassis for instructions on removing the server's cover.
5. Locate the processor socket and raise the socket handle completely (see [Figure 12](#)).

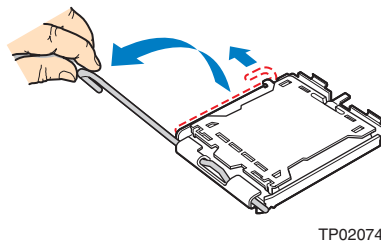

Figure 12. Lifting the Processor Socket Handle

6. Raise the CPU load plate (see [Figure 13](#)).

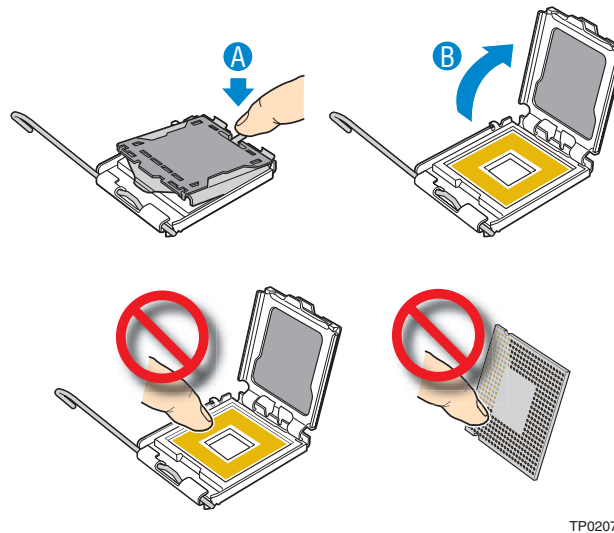

Figure 13. Installing the Processor

Note: Do not touch the socket pins; they are very sensitive and easily damaged.

7. Line up the alignment marks on the processor and the socket, and insert the processor into the socket.

Note: Make sure the alignment triangle mark and the alignment triangle cutout align correctly.

8. Remove the protective socket cover (see [Figure 14](#)).

Note: Retain the protective socket cover for use when removing a processor that will not be replaced.

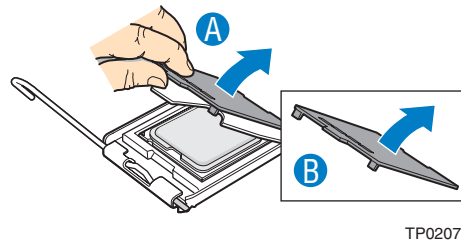

TP02076

Figure 14. Removing the Socket Cover

9. Lower the CPU load plate and lower the socket lever completely.

Installing the Heat Sink(s)

The heat sink has Thermal Interface Material (TIM) located on the bottom of it. Use caution when you unpack the heat sink so you do not damage the TIM.

1. Set the heat sink over the processor, lining up the four captive screws with the four posts surrounding the processor.
2. Loosely screw in the captive screws on the heat sink corners in a diagonal manner. Do not fully tighten one screw before tightening another.
3. Gradually and equally tighten each captive screw until each is firmly tightened.

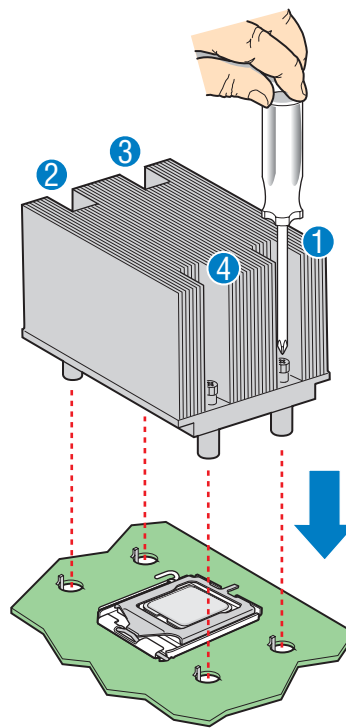

TP02077

Figure 15. Installing the Heat Sink

4. Reinstall and reconnect any parts you removed or disconnected to reach the processor sockets.
5. Replace the server's cover and reconnect the AC power cord. See the documentation that came with your server chassis for instructions on installing the server's cover.

Removing a Processor

1. Observe the safety and ESD precautions in [“Safety Information”](#).
2. Turn off all peripheral devices connected to the server. Turn off the server.
3. Remove the AC power cord from the server.
4. Remove the server's cover. See the documentation that came with your server chassis for instructions on removing the server's cover.
5. Unplug the processor fan cable from the server board.
6. Loosen the four captive screws on the corners of the heat sink.
7. Twist the heat sink slightly to break the seal between the heat sink and the processor.
8. Lift the heat sink from the processor. If it does not pull up easily, twist the heat sink again. Do not force the heat sink from the processor. Doing so could damage the processor.
9. Lift the processor lever.
10. Raise the CPU load plate.
11. Remove the processor.
12. If installing a replacement processor, see [“Installing the Processor”](#). Otherwise, install the protective socket cover over the empty processor socket and reinstall the chassis cover.

Replacing the Backup Battery

The lithium battery on the server board powers the RTC for up to 10 years in the absence of power. When the battery starts to weaken, it loses voltage, and the server settings stored in CMOS RAM in the RTC (for example, the date and time) may be wrong. Contact your customer service representative or dealer for a list of approved devices.

Warning: *Danger of explosion if battery is incorrectly replaced. Replace only with the same or equivalent type recommended by the equipment manufacturer. Discard used batteries according to manufacturer's instructions.*

Advarsel: Lithiumbatteri - Eksplosionsfare ved fejlagtig håndtering. Udskiftning må kun ske med batteri af samme fabrikat og type. Levér det brugte batteri tilbage til leverandøren.

Advarsel: Lithiumbatteri - Eksplosjonsfare. Ved utskifting benyttes kun batteri som anbefalt av apparatfabrikanten. Brukt batteri returneres apparatleverandøren.

Warning: Explosionsfara vid felaktigt batteribyte. Använd samma batterityp eller en ekvivalent typ som rekommenderas av apparattillverkaren. Kassera använt batteri enligt fabrikantens instruktion.

Varoitus: Paristo voi räjähtää, jos se on virheellisesti asennettu. Vaihda paristo ainoastaan laitevalmistajan suosittelemaan tyyppiin. Hävitä käytetty paristo valmistajan ohjeiden mukaisesti.

1. Observe the safety and ESD precautions in “[Safety Information](#)”.
2. Turn off all peripheral devices connected to the server. Turn off the server.
3. Disconnect the AC power cord from the server.
4. Remove the server's cover and locate the battery. See the documentation that came with your server chassis for instructions on removing the server's cover.
5. Insert the tip of a small flat bladed screwdriver, or an equivalent, under the tab in the plastic retainer. Gently push down on the screwdriver to lift the battery.
6. Remove the battery from its socket.

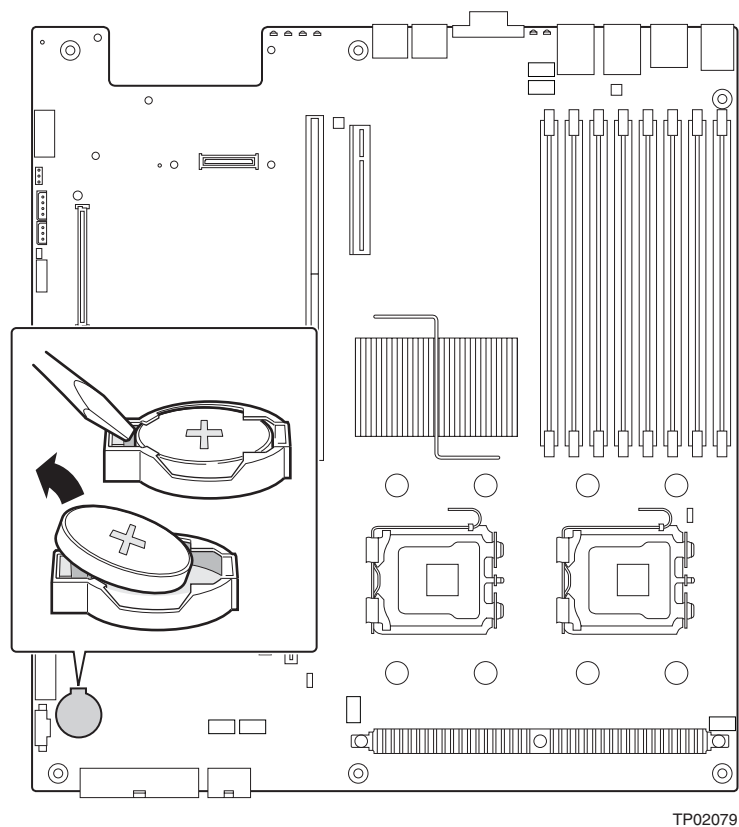

Figure 16. Replacing the Backup Battery

7. Dispose of the battery according to local ordinance.
8. Remove the new lithium battery from its package, and, being careful to observe the correct polarity, insert it in the battery socket.
9. Close the chassis.
10. Run Setup to restore the configuration settings to the RTC.

Appendix A: Getting Help

World Wide Web

<http://support.intel.com/support/motherboards/server/S5000PAL>.

Telephone

All calls are billed per incident, levied in local currency at the applicable credit card exchange rate plus applicable taxes. (Intel reserves the right to change the pricing for telephone support at any time without notice).

Before calling, fill out an “[Intel® Server Issue Report Form](#)”. A sample form is provided on the following pages. However, for the fastest service, please submit your form via the Internet.

For an updated support contact list, see <http://www.intel.com/support/9089.htm/>

U.S. and Canada

916-377-7000

Europe

Belgium 02 714 3182

Denmark ... 38 487077

Finland 9 693 79297

France..... 01 41 918529

Germany ... 069 9509 6099

Holland 020 487 4562

Italy..... 02 696 33276

Norway 23 1620 50

Spain..... 91 377 8166

Sweden..... 08 445 1251

UK..... 870 6072439

In Asia-Pacific Region

Australia.... 1800 649931

Cambodia.. 63 2 636 9797 (via Philippines)

China 800 820 1100 (toll-free)
..... 8 621 33104691 (not toll-free)

Hong Kong 852 2 844 4456

India..... 0006517 2 68303634 (manual toll-free. You need an IDD-equipped telephone)

Indonesia ... 803 65 7249

Korea 822 767 2595

Malaysia 1 800 80 1390

Myanmar... 63 2 636 9796 (via Philippines)

New Zealand 0800 444 365

Pakistan.... 632 63684 15 (IDD via Philippines)

Philippines 1 800 1 651 0117

Singapore .. 65 6213-1311

Taiwan 2 2545-1640

Thailand 1 800 631 0003

Vietnam 632 6368416 (IDD via Philippines)

Japan

Domestic.... 0120 868686

Outside country 81 298 47 0800

Latin America

Argentina .. Contact AT&T USA at 0-800 222 1288. Once connected, dial 800 843 4481

Brazil 001-916 377 0180

Chile

Easter Island. Contact AT&T USA at 800 800 311. Once connected, dial 800 843 4481

Mainland and Juan .. Contact AT&T USA at 800 225 288. Once connected, dial 800 843 4481

Colombia... Contact AT&T USA at 01 800 911 0010. Once connected, dial 800 843 4481

Costa Rica . Contact AT&T USA at 0 800 0 114 114. Once connected, dial 800 843 4481

Ecuador

(Andimate) Contact AT&T USA at 1 999 119. Once connected, dial 800 843 4481

(Pacifictel) Contact AT&T USA at 1 800 225 528. Once connected, dial 800 843 4481

Guatemala. Contact AT&T USA at 99 99 190. Once connected, dial 800 843 4481

Mexico Contact AT&T USA at 001 800 462 628 4240. Once connected, dial 800 843 4481

Miami 1 800 621 8423

Panama..... Contact AT&T USA at 00 800 001 0109. Once connected, dial 800 843 4481

Paraguay ... 001 916 377 0114

Peru 001 916 377 0114

Uruguay..... 001 916 377 0114

Venezuela... Contact AT&T USA at 0 800 2255 288. Once connected, dial 800 843 4481

Appendix B: Regulatory and Compliance Information

Product Regulatory Compliance

Product Safety Compliance

The Intel® Server Board S5000PAL complies with the following safety requirements:

- UL60950 - CSA 60950 (USA / Canada)
- EN60950 (Europe)
- IEC60950 (International)
- CB Certificate & Report, IEC60950 (report to include all country national deviations)
- GOST R 50377-92 - Listed on one System License (Russia)
- Belarus License - Listed on System License (Belarus)
- CE - Low Voltage Directive 73/23/EEE (Europe)
- IRAM Certification (Argentina)

Product EMC Compliance - Class A Compliance

Note: *Legally this product is required to comply with Class A emission requirements as it is intended for a commercial type market place. Intel targets 10db margin to Class A Limits.*

The Intel® Server Board S5000PAL has been tested and verified to comply with the following electromagnetic compatibility (EMC) regulations when installed a compatible Intel® host system. For information on compatible host system(s) see Intel's Server Builder Web site or contact your local Intel representative.

- FCC /ICES-003 - Emissions (USA/Canada) Verification
- CISPR 22 - Emissions (International)
- EN55022 - Emissions (Europe)
- EN55024 - Immunity (Europe)
- CE - EMC Directive 89/336/EEC (Europe)
- AS/NZS 3548 Emissions (Australia / New Zealand)
- BSMI CNS13438 Emissions (Taiwan)
- GOST R 29216-91 Emissions - Listed on one System License (Russia)

- GOST R 50628-95 Immunity -Listed on one System License (Russia)
- Belarus License - Listed on one System License (Belarus)
- RRL MIC Notice No. 1997-41 (EMC) & 1997-42 (EMI) (Korea)

Certifications / Registrations / Declarations

- UL Certification (US/Canada)
- CE Declaration of Conformity (CENELEC Europe)
- FCC/ICES-003 Class A Attestation (USA/Canada)
- C-Tick Declaration of Conformity (Australia)
- MED Declaration of Conformity (New Zealand)
- BSMI Certification (Taiwan)
- GOST - Listed on one System License (Russia)
- Belarus - Listed on one System License (Belarus)
- RRL Certification (Korea)
- Ecology Declaration (International)

Product Regulatory Compliance Markings

This product is provided with the following Product Certification Markings:

Table 5. Product Certification Markings





Regulatory Compliance	Region	Marking
UL Mark	USA/Canada	
CE Mark	Europe	
FCC Marking (Class A)	USA	This device complies with Part 15 of the FCC Rules. Operation of this device is subject to the following two conditions: (1) This device may not cause harmful interference, and (2) This device must accept any interference received, including interference that may cause undesired operation. Manufactured by Intel Corporation
EMC Marking (Class A)	Canada	CANADA ICES-003 CLASS A CANADA NMB-003 CLASSE A

Table 5. Product Certification Markings

Regulatory Compliance	Region	Marking
C-Tick Mark	Australia / New Zealand	
BSMI Marking (Class A)	Taiwan	 <div style="border: 1px solid black; padding: 5px; margin-top: 5px;"> <p>警告使用者： 這是甲類的資訊產品，在居住的環境中使用時， 可能會造成射頻干擾，在這種情況下，使用者會 被要求採取某些適當的對策</p> </div>
RLL MIC Mark	Korea	 <p>製造商：CPU</p>

Electromagnetic Compatibility Notices

FCC (USA)

This device complies with Part 15 of the FCC Rules. Operation is subject to the following two conditions: (1) this device may not cause harmful interference, and (2) this device must accept any interference received, including interference that may cause undesired operation.

For questions related to the EMC performance of this product, contact:

Intel Corporation
5200 N.E. Elam Young Parkway
Hillsboro, OR 97124-6497
1-800-628-8686

This equipment has been tested and found to comply with the limits for a Class A digital device, pursuant to Part 15 of the FCC Rules. These limits are designed to provide reasonable protection against harmful interference in a residential installation. This equipment generates, uses, and can radiate radio frequency energy and, if not installed and used in accordance with the instructions, may cause harmful interference to radio communications. However, there is no guarantee that interference will not occur in a particular installation. If this equipment does cause harmful interference to radio or television reception, which can be determined by turning the equipment off and on, the user is encouraged to try to correct the interference by one or more of the following measures:

- Reorient or relocate the receiving antenna.

- Increase the separation between the equipment and the receiver.
- Connect the equipment to an outlet on a circuit other than the one to which the receiver is connected.
- Consult the dealer or an experienced radio/TV technician for help.

Any changes or modifications not expressly approved by the grantee of this device could void the user's authority to operate the equipment. The customer is responsible for ensuring compliance of the modified product.

Only peripherals (computer input/output devices, terminals, printers, etc.) that comply with FCC Class A or B limits may be attached to this computer product. Operation with noncompliant peripherals is likely to result in interference to radio and TV reception.

All cables used to connect to peripherals must be shielded and grounded. Operation with cables, connected to peripherals, that are not shielded and grounded may result in interference to radio and TV reception.

Industry Canada (ICES-003)

Cet appareil numérique respecte les limites bruits radioélectriques applicables aux appareils numériques de Classe A prescrites dans la norme sur le matériel brouilleur: "Appareils Numériques", NMB-003 édictée par le Ministre Canadien des Communications.

This digital apparatus does not exceed the Class A limits for radio noise emissions from digital apparatus set out in the interference-causing equipment standard entitled: "Digital Apparatus," ICES-003 of the Canadian Department of Communications.

Europe (CE Declaration of Conformity)

This product has been tested in accordance too, and complies with the Low Voltage Directive (73/23/EEC) and EMC Directive (89/336/EEC). The product has been marked with the CE Mark to illustrate its compliance.

Taiwan Declaration of Conformity (BSMI)

<p>警告使用者： 這是甲類的資訊產品，在居住的環境中使用時， 可能會造成射頻干擾，在這種情況下，使用者會 被要求採取某些適當的對策</p>
--

The BSMI Certification Marking and EMC warning is located on the outside rear area of the product.

Korean Compliance (RRL)



1. 기기의 명칭(모델명) :
2. 인증번호 :
3. 인증받은 자의 상호 :
4. 제조년월일 :
5. 제조자/제조국가 :

English translation of the notice above:

1. Type of Equipment (Model Name): On License and Product
2. Certification No.: On RRL certificate. Obtain certificate from local Intel representative
3. Name of Certification Recipient: Intel Corporation
4. Date of Manufacturer: Refer to date code on product
5. Manufacturer/Nation: Intel Corporation/Refer to country of origin marked on product

Restriction of Hazardous Substances (RoHS) Compliance

Intel has a system in place to restrict the use of banned substances in accordance with the European Directive 2002/95/EC. Compliance is based on declaration that materials banned in the RoHS Directive are either (1) below all applicable substance threshold limits or (2) an approved/pending RoHS exemption applies.

Note: RoHS implementing details are not fully defined and may change.

Threshold limits and banned substances are noted below.

- Quantity limit of 0.1% by mass (1000 PPM) for:
 - Lead
 - Mercury
 - Hexavalent Chromium
 - Polybrominated Biphenyls Diphenyl Ethers (PBDE)
- Quantity limit of 0.01% by mass (100 PPM) for:
 - Cadmium

End-of-Life / Product Recycling

Product recycling and end-of-life take-back systems and requirements vary by country. Contact the retailer or distributor of this product for information about product recycling and / or take-back.

Appendix C: Troubleshooting

This chapter helps you identify and solve problems that might occur while you are using the system.

For any issue, first ensure you are using the latest firmware and files. Firmware upgrades include updates for BIOS, the Baseboard Management Controller (BMC), and the hot-swap controller (HSC). See [“Additional Information and Software”](#) for a link to the software updates. In addition to the server firmware and files, also update any drivers used for components you have installed in your system, such as video drivers, network drivers, and SATA drivers.

Intel provides a package called the "Platform Confidence Test" that may help with your diagnostics. See [“Additional Information and Software”](#) for a link to this software.

If you are unable to resolve your server problems on your own, see [“Getting Help”](#) for assistance.

Resetting the System

Before going through in-depth troubleshooting, attempt first to perform reset your system using one of the methods below.

Table 6. Resetting the System

To do this	Press
Soft boot reset to clear the system memory and reload the operating system	<Ctrl+Alt+Del>
Clear system memory, restart POST, and reload the operating system	Reset button
Cold boot reset. Turn the system power off and then on. This clears system memory, restarts POST, reloads the operating system, and halts power to all peripherals	Power off/on button
Reset the BMC and get it back to a stable state	Remove AC power from the server for one minute

Problems following Initial System Installation

Problems that occur at initial system startup are usually caused by an incorrect installation or configuration. Hardware failure is a less frequent cause. If the problem you are experiencing is with a specific software application, see [“Problems with Newly Installed Application Software”](#).

First Steps Checklist

- Is AC power available at the wall outlet?
- Are the power supplies plugged in? Check the AC cable(s) on the back of the chassis and at the AC source.
- Are all cables correctly connected and secured?
- Are the processors fully seated in their sockets on the server board?
- Are all standoffs in the proper location and not touching any components, causing a potential short?
- Are all add-in PCI boards fully seated in their slots on the server board?
- Are all jumper settings on the server board correct?
- Are all jumper and switch settings on add-in boards and peripheral devices correct? To check these settings, refer to the manufacturer's documentation that comes with them. If applicable, ensure that there are no conflicts—for example, two add-in boards sharing the same interrupt.
- Are all peripheral devices installed correctly?
- If the system has a hard disk drive, is it properly formatted or configured?
- Are all device drivers properly installed?
- Are the configuration settings made in Setup correct?
- Is the operating system properly loaded? See the operating system documentation.
- Did you press the system power on/off switch on the front panel to turn the server on (power on light should be lit)?
- Is the system power cord properly connected to the system and plugged into a NEMA 5 15R outlet for 100-120V or a NEMA 6-15R outlet for 200-240V ?
- Are all integrated components from the tested components lists? Check the tested memory, and chassis lists, as well as the supported hardware and operating system list. See [“Additional Information and Software”](#) for links to the tested component lists.

Hardware Diagnostic Testing

This section provides a more detailed approach to identifying a hardware problem and locating its source.

Caution: *Turn off devices before disconnecting cables: Before disconnecting any peripheral cables from the system, turn off the system and any external peripheral devices. Failure to do so can cause permanent damage to the system and/or the peripheral devices.*

1. Turn off the system and all external peripheral devices. Disconnect each device from the system, except for the keyboard and the video monitor.
2. Make sure the system power cord is plugged into a properly grounded AC outlet.
3. Make sure your video display monitor and keyboard are correctly connected to the system. Turn on the video monitor. Set its brightness and contrast controls to at least two thirds of their maximum ranges (see the documentation supplied with your video display monitor).
4. If the operating system normally loads from the hard disk drive, make sure there is no CD-ROM / DVD disk in the optical drive.
5. If the power LED does light, attempt to boot from a USB floppy or from a CD-ROM disk.
6. Turn on the system. If the power LED does not light, see [“Power Light Does Not Light”](#).

Verifying Proper Operation of Key System Lights

As POST determines the system configuration, it tests for the presence of each mass storage device installed in the system. As each device is checked, its activity light should turn on briefly. Check for the following:

- Does the drive activity light turn on briefly? If not, see [“Drive Activity Light Does Not Light”](#).
- If system LEDs are illuminated, see [“Make sure the BIOS is configured to allow the CD-ROM to be the first bootable device.”](#) for a description of the light and steps to take to correct the problem.

Confirming Loading of the Operating System

Once the system boots up, the operating system prompt appears on the screen. The prompt varies according to the operating system. If the operating system prompt does not appear, see [“No Characters Appear on Screen”](#).

Specific Problems and Corrective Actions

This section provides possible solutions for these specific problems:

- Power light does not light.
- No characters appear on screen.
- Characters on the screen appear distorted or incorrect.
- System cooling fans do not rotate.
- Diskette drive activity light does not light.
- Hard disk drive activity light does not light.
- CD-ROM drive activity light does not light.
- There are problems with application software.
- The bootable CD-ROM is not detected.

Try the solutions below in the order given. If you cannot correct the problem, contact your service representative or authorized dealer for help.

Power Light Does Not Light

Check the following:

- Did you press the power-on button?
- Is the system operating normally? If so, the power LED might be defective or the connection from the control panel to the server board might be loose.
- Have you securely plugged the server AC power cord into the power supply?
- Some ATX power supplies have a power switch on the back of the power supply, next to the fan. If your system has one, is it turned on?
- Remove all add-in cards and see if the system boots. If successful, add the cards back in one at a time with a reboot between each addition.
- Make sure the memory DIMMs comply with the system requirements.
- Make sure the memory DIMMs have been populated according to the system requirements.
- Remove the memory DIMMs and re-seat them.
- Make sure the processor(s) comply with the system requirements.
- Make sure the processor(s) have been populated according to the system requirements.
- Remove the processor(s) and re-seat them.
- Make sure the chassis standoffs are installed only below mounting holes. Misplaced standoffs can contact the pins on the bottom of the server board and cause a short.

No Characters Appear on Screen

Check the following:

- Is the keyboard functioning? Test it by turning the "Num Lock" function on and off to make sure the Num Lock light is functioning.
- Is the video monitor plugged in and turned on? If you are using a switch box, is it switched to the correct system?
- Are the brightness and contrast controls on the video monitor properly adjusted?
- Is the video monitor signal cable properly installed?
- Does this video monitor work correctly if plugged into a different system?
- Is the onboard video controller enabled in the BIOS?
- Remove all add-in cards and see if the video returns. If successful, add the cards back in one at a time with a reboot between each addition.
- Make sure the memory DIMMs comply with the system requirements.
- Make sure the memory DIMMs have been populated according to the system requirements.
- Remove the memory DIMMs and re-seat them.
- Make sure the processor(s) comply with the system requirements.
- Make sure the processor(s) have been populated according to the system requirements.
- Remove the processor(s) and re-seat them.

If you are using an add-in video controller board, do the following:

1. Verify that the video works using the onboard video controller.
2. Verify that the video controller board is fully seated in the server board connector.
3. Reboot the system for changes to take effect.
4. If there are still no characters on the screen after you reboot the system and POST emits a beep code, write down the beep code you hear. This information is useful for your service representative.
5. If you do not receive a beep code and characters do not appear, the video display monitor or video controller may have failed. Contact your service representative or authorized dealer for help.

Characters Are Distorted or Incorrect

Check the following:

- Are the brightness and contrast controls properly adjusted on the video monitor? See the manufacturer's documentation.
- Are the video monitor's signal and power cables properly installed?

- Does this video monitor work correctly if plugged into a different system?

System Cooling Fans Do Not Rotate Properly

If the system cooling fans are not operating properly, it is an indication of possible system component failure.

Check the following:

- Is the power-on light lit? If not, see “[Power Light Does Not Light](#)”.
- If your system has LED lights for the fans, is one or more of these LEDs lit?
- Are any other control panel LEDs lit?
- Have any of the fan motors stopped? Use the server management subsystem to check the fan status.
- Have your fans speeded up in response to an overheating situation?
- Have your fans speeded up in response to a fan that has failed?
- Are the fan power connectors properly connected to the server board?
- Is the cable from the control panel board connected to the both the control panel board and to the server board?
- Are the power supply cables properly connected to the server board?
- Are there any shorted wires caused by pinched-cables or have power connector plugs been forced into power connector sockets the wrong way?

Drive Activity Light Does Not Light

Check the following:

- Are the drive's power and signal cables properly installed?
- Are all relevant switches and jumpers on the drive set correctly?
- Is the drive properly configured?
- Is the drive activity light always on? If so, the signal cable may be plugged in incorrectly.

CD-ROM Drive or DVD-ROM Drive Activity Light Does Not Light

Check the following:

- Are the CD-ROM/DVD-ROM drive's power and signal cables properly installed?
- Are all relevant switches and jumpers on the drive set correctly?
- Is the drive properly configured?

Cannot Connect to a Server

- Make sure the network cable is securely attached to the correct connector at the system back panel.
- Try a different network cable.
- Make sure you are using the correct and the current drivers. See [“Additional Information and Software”](#) for a link to the current drivers.
- Make sure the driver is loaded and the protocols are bound.
- Make sure the hub port is configured for the same duplex mode as the network controller.
- Make sure the correct networking software is installed.
- If you are directly connecting two servers (without a hub), you will need a crossover cable.
- Check the network controller LEDs next to the NIC connectors.

Problems with Network

The server hangs when the drivers are loaded

- Certain drivers may require interrupts that are not shared with other PCI drivers. For these drivers, it may be necessary to alter settings so that interrupts are not shared. See the documentation that came with your PCI card(s) for information on changing interrupts.

Diagnostics pass but the connection fails

- Make sure the network cable is securely attached.
- Make sure you specify the correct frame type in your NET.CFG file.
- The controller stopped working when an add-in adapter was installed.
- Make sure the cable is connected to the port from the onboard network controller.
- Make sure your BIOS is current. See [“Additional Information and Software”](#) for a link to the current version.
- Make sure the other adapter supports shared interrupts. Make sure your operating system supports shared interrupts.
- Try reseating the add-in adapter.

The add-in adapter stopped working without apparent cause

- Reseat the adapter.
- Put the adapter in a different slot.

- The network driver files may be corrupt or deleted. Delete and then reinstall the drivers.
- Run diagnostics.

System Boots when Installing PCI Card

System Management features require full-time "standby" power. This means some parts of the system have power going to them whenever the power cord is plugged in, even if you have turned the system power off with the power button on the front panel. If you install a PCI card with the AC power cord plugged in, a signal may be sent to command the system to boot. Before installing a PCI card, you should always:

- Turn off the server power by using the power button on the front of the system.
- Unplug the AC power cord(s) from the server.

Problems with Newly Installed Application Software

Problems that occur when you run new application software are usually related to the software, not the server hardware. Faulty equipment is unlikely, especially if other software runs correctly.

Check the following:

- Make sure the system meets the minimum hardware requirements for the software. See the software documentation.
- Make sure the software is properly installed and configured for the system. See the software documentation.
- Use only an authorized copy. Unauthorized copies often do not work.
- If you are running the software from a CD-ROM or DVD-ROM, try a different disk.
- Make sure the correct device drivers installed.

If the problems persist, contact the software vendor's customer service representative.

Problems with Application Software that Ran Correctly Earlier

Problems that occur after the system hardware and software have been running correctly sometimes indicate equipment failure. However, they can also be caused by file corruption or changes to the software configuration.

Check the following:

- If you are running the software from a CD-ROM or DVD-ROM, try a different disk.
- Check your system for a virus infection.
- Uninstall and reinstall the software. Make sure all necessary files are installed.

- If the problems are intermittent, there may be a loose cable, dirt in the keyboard (if keyboard input is incorrect), a marginal power supply, or other random component failures.
- If you suspect that a transient voltage spike, power outage, or brownout might have occurred, reload the software and try running it again. Symptoms of voltage spikes include a flickering video display, unexpected system reboots, and the system not responding to user commands.

Note: Random errors in data files: If you are getting random errors in your data files, they may be getting corrupted by voltage spikes on your power line. If you are experiencing any of the above symptoms that might indicate voltage spikes on the power line, you may want to install a surge suppressor between the power outlet and the system power cord.

Devices are not Recognized under Device Manager (Microsoft* Windows* Operating System)

The Microsoft* Windows* operating systems do not include all of the drivers for the Intel® chipsets, onboard NICs, and other components. See [“Additional Information and Software”](#) for a link to the current drivers and chipset files.

Hard Drive(s) are not Recognized

Check the following:

- Make sure the drive is not disabled in BIOS Setup.
- Make sure the drive is connected correctly and that is plugged into the power supply.
- Make sure the drive is compatible. See [“Additional Information and Software”](#) for a link to the tested drives.
- Make sure you have not exceeded the power budget for the server. See [“Additional Information and Software”](#) for a link to software to check your power budget.
- If using SCSI drives, verify that each SCSI ID number is unique on the SCSI bus. See your drive documentation for details on setting the SCSI ID for your drives.
- If using ATA drives, verify that the master/slave settings are set correctly. See your drive documentation for details on setting the master/slave settings.
- If using a RAID configuration with SCSI or SATA drives, make sure the RAID card is installed correctly.

Bootable CD-ROM Disk Is Not Detected

Check the following:

- Make sure the BIOS is configured to allow the CD-ROM to be the first bootable device.

LED Information

The Intel® Server Board S5000PAL includes LEDs that can aid in troubleshooting your system. A table of these LEDs with a description of their use is listed below.

Table 7. LED Information

LED Name	Function	Location	LED Color	Notes
Power	Indicates system power is on or off	Front control panel	Green	Off = Power is off or in sleep state S5 On = Power is on or in sleep state S0
ID	Aid in server identification from the back panel	Front control panel and board rear left corner	Blue	Press ID LED button or use Server Management software to turn the LED on and off.
System Status	Visible fault warning	Control panel and board rear left corner	Green or Amber	Green = No Fault Green blinking = degraded condition Amber blinking = non-critical error Amber = critical or non-recoverable error

BIOS POST Beep Codes

The table below lists the POST error beep codes. Prior to system video initialization, the BIOS uses these beep codes to inform users of error conditions. Please note that not all error conditions are supported by BIOS beep codes.

Table 8. POST Error Beep Codes

Number of Beeps	Reason for Beeps and Action to Take
1, 2, or 3	Memory error. Reseat the memory or replace the DIMMs with known good modules.
4 - 7 or 9 - 11	Fatal error indicating a possible serious system problem. Remove all add-in cards and re-start the system. If the error still occurs, contact your system manufacturer. If the beep codes are not generated after the add-in cards are removed, insert the cards one at a time, booting the system between each card addition, until the beeps again occur to reveal the malfunctioning card.
8	Replace or reseat the system video add-in card. If on-board video is being used, the server board may be faulty.

In addition to the beep codes above, additional beep codes are provided if an Intel® Remote Management Module is installed. The Intel® Remote Management Module provides the following additional beep codes.

Table 9. Error Beep Codes Generated by Intel® Remote Management Module

Number of Beeps	Reason for Beeps and Action to Take
1	Control panel CMOS clear has been initiated.
1-5-1-1	Processor failure. Reseat or replace the failed processor.
1-5-2-1	No processor is installed or the CPU 1 socket is empty. Reseat or replace the failed processor.
1-5-2-3	Processor configuration error or CPU 1 socket is empty. Reseat or replace the failed processor. In a two-processor system, make sure the processors are identical.
1-5-2-4	Front-side bus select configuration error.
1-5-4-2	DC power unexpectedly lost.
1-5-4-3	Chipset control failure.
1-5-4-4	Power control failure.

Appendix D: LED Decoder

During the system boot process, BIOS executes a number of platform configuration processes, each of which is assigned a specific hex POST code number. As each configuration routine is started, BIOS will display the given POST code to the POST Code Diagnostic LEDs found on the back edge of the server board. To assist in troubleshooting a system hang during the POST process, the Diagnostic LEDs can be used to identify the last POST process to be executed.

Each POST code will be represented by a combination of colors from the four LEDs. The LEDs are capable of displaying three colors: green, red, and amber. The POST codes are divided into two nibbles, an upper nibble and a lower nibble. Each bit in the upper nibble is represented by a red LED and each bit in the lower nibble is represented by a green LED. If both bits are set in the upper and lower nibbles then both red and green LEDs are lit, resulting in an amber color. If both bits are clear, then the LED is off.

In the below example, BIOS sends a value of ACh to the diagnostic LED decoder. The LEDs are decoded as follows:

- red bits = 1010b = Ah
- green bits = 1100b = Ch

Since the red bits correspond to the upper nibble and the green bits correspond to the lower nibble, the two are concatenated to be ACh.

Table 10. POST Progress Code LED Example

	8h		4h		2h		1h	
LEDs	Red	Green	Red	Green	Red	Green	Red	Green
ACh	1	1	0	1	1	0	0	0
Result	Amber		Green		Red		Off	
	MSB						LSB	

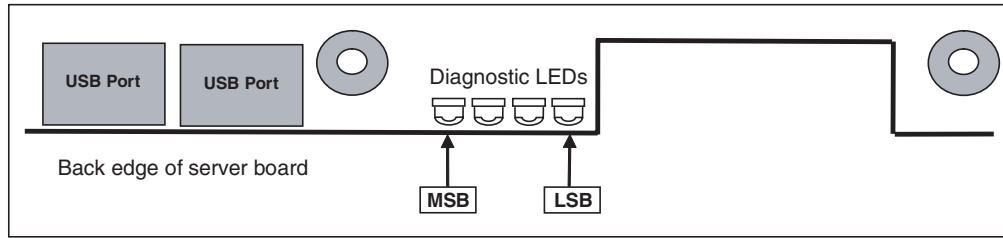

Figure 17. Diagnostic LED Placement Diagram

Table 11. Diagnostic LED POST Code Decoder

Checkpoint	Diagnostic LED Decoder				Description
	G=Green, R=Red, A=Amber				
	MSB			LSB	
Host Processor					
0x10h	OFF	OFF	OFF	R	Power-on initialization of the host processor (bootstrap processor)
0x11h	OFF	OFF	OFF	A	Host processor cache initialization (including AP)
0x12h	OFF	OFF	G	R	Starting application processor initialization
0x13h	OFF	OFF	G	A	SMM initialization
Chipset					
0x21h	OFF	OFF	R	G	Initializing a chipset component
Memory					
0x22h	OFF	OFF	A	OFF	Reading configuration data from memory (SPD on DIMM)
0x23h	OFF	OFF	A	G	Detecting presence of memory
0x24h	OFF	G	R	OFF	Programming timing parameters in the memory controller
0x25h	OFF	G	R	G	Configuring memory parameters in the memory controller
0x26h	OFF	G	A	OFF	Optimizing memory controller settings
0x27h	OFF	G	A	G	Initializing memory, such as ECC init
0x28h	G	OFF	R	OFF	Testing memory

Table 11. Diagnostic LED POST Code Decoder

PCI Bus					
0x50h	OFF	R	OFF	R	Enumerating PCI busses
0x51h	OFF	R	OFF	A	Allocating resources to PCI busses
0x52h	OFF	R	G	R	Hot Plug PCI controller initialization
0x53h	OFF	R	G	A	Reserved for PCI bus
0x54h	OFF	A	OFF	R	Reserved for PCI bus
0x55h	OFF	A	OFF	A	Reserved for PCI bus
0x56h	OFF	A	G	R	Reserved for PCI bus
0x57h	OFF	A	G	A	Reserved for PCI bus
USB					
0x58h	G	R	OFF	R	Resetting USB bus
0x59h	G	R	OFF	A	Reserved for USB devices
ATA / ATAPI / SATA					
0x5Ah	G	R	G	R	Resetting PATA / SATA bus and all devices
0x5Bh	G	R	G	A	Reserved for ATA
SMBUS					
0x5Ch	G	A	OFF	R	Resetting SMBUS
0x5Dh	G	A	OFF	A	Reserved for SMBUS
Local Console					
0x70h	OFF	R	R	R	Resetting the video controller (VGA)
0x71h	OFF	R	R	A	Disabling the video controller (VGA)
0x72h	OFF	R	A	R	Enabling the video controller (VGA)
Remote Console					
0x78h	G	R	R	R	Resetting the console controller
0x79h	G	R	R	A	Disabling the console controller
0x7Ah	G	R	A	R	Enabling the console controller
Keyboard (PS2 or USB)					
0x90h	R	OFF	OFF	R	Resetting the keyboard
0x91h	R	OFF	OFF	A	Disabling the keyboard
0x92h	R	OFF	G	R	Detecting the presence of the keyboard

Table 11. Diagnostic LED POST Code Decoder

0x93h	R	OFF	G	A	Enabling the keyboard
0x94h	R	G	OFF	R	Clearing keyboard input buffer
0x95h	R	G	OFF	A	Instructing keyboard controller to run Self Test (PS2 only)
Mouse (PS2 or USB)					
0x98h	A	OFF	OFF	R	Resetting the mouse
0x99h	A	OFF	OFF	A	Detecting the mouse
0x9Ah	A	OFF	G	R	Detecting the presence of mouse
0x9Bh	A	OFF	G	A	Enabling the mouse
Fixed Media					
0xB0h	R	OFF	R	R	Resetting fixed media device
0xB1h	R	OFF	R	A	Disabling fixed media device
0xB2h	R	OFF	A	R	Detecting presence of a fixed media device (IDE hard drive detection, etc.)
0xB3h	R	OFF	A	A	Enabling / configuring a fixed media device
Removable Media					
0xB8h	A	OFF	R	R	Resetting removable media device
0xB9h	A	OFF	R	A	Disabling removable media device
0xBAh	A	OFF	A	R	Detecting presence of a removable media device (IDE CDROM detection, etc.)
0xBCh	A	G	R	R	Enabling / configuring a removable media device
Boot Device Selection					
0xD0	R	R	OFF	R	Trying boot device selection
0xD1	R	R	OFF	A	Trying boot device selection
0xD2	R	R	G	R	Trying boot device selection
0xD3	R	R	G	A	Trying boot device selection
0xD4	R	A	OFF	R	Trying boot device selection
0xD5	R	A	OFF	A	Trying boot device selection
0xD6	R	A	G	R	Trying boot device selection
0xD7	R	A	G	A	Trying boot device selection
0xD8	A	R	OFF	R	Trying boot device selection
0xD9	A	R	OFF	A	Trying boot device selection

Table 11. Diagnostic LED POST Code Decoder

0XDA	A	R	G	R	Trying boot device selection
0xDB	A	R	G	A	Trying boot device selection
0xDC	A	A	OFF	R	Trying boot device selection
0xDE	A	A	G	R	Trying boot device selection
0xDF	A	A	G	A	Trying boot device selection
Pre-EFI Initialization (PEI) Core					
0xE0h	R	R	R	OFF	Started dispatching early initialization modules (PEIM)
0xE2h	R	R	A	OFF	Initial memory found, configured, and installed correctly
0xE1h	R	R	R	G	Reserved for initialization module use (PEIM)
0xE3h	R	R	A	G	Reserved for initialization module use (PEIM)
Driver Execution Environment (DXE) Core					
0xE4h	R	A	R	OFF	Entered EFI driver execution phase (DXE)
0xE5h	R	A	R	G	Started dispatching drivers
0xE6h	R	A	A	OFF	Started connecting drivers
DXE Drivers					
0xE7h	R	A	A	G	Waiting for user input
0xE8h	A	R	R	OFF	Checking password
0xE9h	A	R	R	G	Entering BIOS setup
0xEAh	A	R	A	OFF	Flash Update
0xEEh	A	A	A	OFF	Calling Int 19. One beep unless silent boot is enabled.
0xEFh	A	A	A	G	Unrecoverable boot failure / S3 resume failure
Runtime Phase / EFI Operating System Boot					
0xF4h	R	A	R	R	Entering Sleep state
0xF5h	R	A	R	A	Exiting Sleep state
0xF8h	A	R	R	R	Operating system has requested EFI to close boot services (ExitBootServices () has been called)
0xF9h	A	R	R	A	Operating system has switched to virtual address mode (SetVirtualAddressMap () has been called)

Table 11. Diagnostic LED POST Code Decoder

0xFAh	A	R	A	R	Operating system has requested the system to reset (ResetSystem () has been called)
Pre-EFI Initialization Module (PEIM) / Recovery					
0x30h	OFF	OFF	R	R	Crisis recovery has been initiated because of a user request
0x31h	OFF	OFF	R	A	Crisis recovery has been initiated by software (corrupt flash)
0x34h	OFF	G	R	R	Loading crisis recovery capsule
0x35h	OFF	G	R	A	Handing off control to the crisis recovery capsule
0x3Fh	G	G	A	A	Unable to complete crisis recovery.

Appendix E: Intel[®] Server Issue Report Form

Note: An on-line / automatic submission version of this form is available at <http://support.intel.com/support/motherboards/server/S5000PAL/>. For the fastest service, please submit your form via the Internet.

Date Submitted: _____

Company Name: _____

Contact Name: _____

Email Address: _____

Intel Server Product: _____

Priority (Critical, Hot, High, Low): _____

Brief Problem Description. Provide a brief description below. See the last page for space to include a detailed problem description.

Board / Chassis Information

Baseboard Revision - PBA#: _____

Baseboard Serial Number: _____

Chassis Model: _____

CPU1 Speed/Stepping/Spec: _____

CPU2 Speed/Stepping/Spec: _____

System BIOS Version: _____

HSC Firmware Version: _____

DIMM Configuration

DIMM A1 MB and Vendor / part number: _____

DIMM A2 MB and Vendor / part number: _____

DIMM B1 MB and Vendor / part number: _____

DIMM B2 MB and Vendor / part number: _____

DIMM C1 MB and Vendor / part number: _____

DIMM C2 MB and Vendor / part number: _____

DIMM D1 MB and Vendor / part number: _____

DIMM D2 MB and Vendor / part number: _____

Operating System Information

Operating System: _____

Version: _____

Service Pack: _____

Add-in Card, Peripheral, Video, NIC

Check each box below as applicable, and provide the requested information.

Peripheral Card or Peripheral Description Driver Revision IRQ # I/O Base Address NIC

Peripheral	Description	Driver Revision	IRQ	I/O Base Address	FW Revision
PCI-X*					
Top PCI Slot					
Middle PCI Slot					
Bottom PCI Slot					
PCIe* x4					
Top PCI Slot					
Middle PCI Slot					
Bottom PCI Slot					
PCIe x8					
Top PCI Slot					

Peripheral	Description	Driver Revision	IRQ	I/O Base Address	FW Revision
Middle PCI Slot					
Bottom PCI Slot					
Video					
On-board Video					
Add-in Video					
NIC					
On-Board NIC1					
On-Board NIC2					

Hard Drive Information

Drive Type (SATA, SAS, etc)	Make/Model	Hot-swap or Fixed	IRQ	FW Revision

Management Information

On-Board Platform Instrumentation only _____

Intel® System Management Software _____

Control Panel Information

Standard Control Panel _____

Intel® Local Control Panel _____

Mini-Control Panel _____

