

Intel® Server Board S5520HC, S5520HCT and S5500HCV Service Guide

Order Number: E39527-008



Revision 1.4

Disclaimer

Disclaimer

Information in this document is provided in connection with Intel® products. No license, express or implied, by estoppel or otherwise, to any intellectual property rights is granted by this document. Except as provided in Intel's Terms and Conditions of Sale for such products, Intel assumes no liability whatsoever, and Intel disclaims any express or implied warranty, relating to sale and/or use of Intel products including liability or warranties relating to fitness for a particular purpose, merchantability, or infringement of any patent, copyright or other intellectual property right. Intel products are not designed, intended or authorized for use in any medical, life saving, or life sustaining applications or for any other application in which the failure of the Intel product could create a situation where personal injury or death may occur. Intel may make changes to specifications and product descriptions at any time, without notice.

Intel server boards contain a number of high-density VLSI and power delivery components that need adequate airflow for cooling. Intel's own chassis are designed and tested to meet the intended thermal requirements of these components when the fully integrated system is used together. It is the responsibility of the system integrator that chooses not to use Intel developed server building blocks to consult vendor datasheets and operating parameters to determine the amount of airflow required for their specific application and environmental conditions. Intel Corporation can not be held responsible if components fail or the server board does not operate correctly when used outside any of their published operating or non-operating limits.

Intel, Intel Pentium, and Intel Xeon are trademarks or registered trademarks of Intel Corporation or its subsidiaries in the United States and other countries.

* Other names and brands may be claimed as the property of others.

Copyright © 2009-2010, Intel Corporation. All Rights Reserved.

Safety Information

Important Safety Instructions

Before performing any of the instructions, read all caution and safety statements in this document. See also Intel Server Boards and Server Chassis Safety Information on the Intel® Server Deployment Toolkit 3.0 CD and/or at:

<http://support.intel.com/support/motherboards/server/sb/cs-010770.htm>

Wichtige Sicherheitshinweise

Lesen Sie zunächst sämtliche Warnung und Sicherheitshinweise in diesem Dokument, bevor Sie eine der Anweisungen ausführen. Beachten Sie hierzu auch die Sicherheitshinweise zu Intel-Serverplatinen und Servergehäusen auf der Intel® Server Deployment Toolkit 3.0 CD oder unter:

<http://support.intel.com/support/motherboards/server/sb/cs-010770.htm>

Consignes de sécurité

Lisez attention toutes les consignes de sécurité et les mises en garde indiquées dans ce document avant de suivre toute instruction. Consultez Intel Server Boards and Server Chassis Safety Information sur le Intel® Server Deployment Toolkit 3.0 CD ou bien rendez-vous sur le site:

<http://support.intel.com/support/motherboards/server/sb/cs-010770.htm>

Instrucciones de seguridad importantes

Lea todas las declaraciones de seguridad y precaución de este documento antes de realizar cualquiera de las instrucciones. Vea Intel Server Boards and Server Chassis Safety Information en el Intel® Server Deployment Toolkit 3.0 CD y/o en:

<http://support.intel.com/support/motherboards/server/sb/cs-010770.htm>

重要安全指导

在执行任何指令之前，请阅读本文件中的所有注意事项及安全声明。并参阅 <http://support.intel.com/support/motherboards/server/sb/cs-010770.htm> 上的 Intel® Server boards and Server Chassis Safety Information（《Intel 服务器主板与服务器机箱安全信息》）

Warnings

Heed safety instructions: Before working with your server product, whether you are using this guide or any other resource as a reference, pay close attention to the safety instructions. You must adhere to the assembly instructions in this guide to ensure and maintain compliance with existing product certifications and approvals. Use only the described, regulated components specified in this guide. Use of other products/components will void the UL listing and other regulatory approvals of the product and will most likely result in noncompliance with product regulations in the region(s) in which the product is sold.

System power on/off: The power button DOES NOT turn off the system AC power. To remove power from the system, you must unplug the AC power cord from the wall outlet. Make sure the AC power cord is unplugged before you open the chassis, add, or remove any components.

Hazardous conditions, devices and cables: Hazardous electrical conditions may be present on power, telephone, and communication cables. Turn off the server and disconnect the power cord, telecommunications systems, networks, and modems attached to the server before opening it. Otherwise, personal injury or equipment damage can result.

Electrostatic discharge (ESD) and ESD protection: ESD can damage disk drives, boards, and other parts. We recommend that you perform all procedures in this chapter only at an ESD workstation. If one is not available, provide some ESD protection by wearing an antistatic wrist strap attached to chassis ground—any unpainted metal surface—on your server when handling parts.

ESD and handling boards: Always handle boards carefully. They can be extremely sensitive to ESD. Hold boards only by their edges. After removing a board from its protective wrapper or from the server, place the board component side up on a grounded, static free surface. Use a conductive foam pad if available but not the board wrapper. Do not slide board over any surface.

Installing or removing jumpers: A jumper is a small plastic encased conductor that slips over two jumper pins. Some jumpers have a small tab on top that you can grip with your fingertips or with a pair of fine needle nosed pliers. If your jumpers do not have such a tab, take care when using needle nosed pliers to remove or install a jumper; grip the narrow sides of the jumper with the pliers, never the wide sides. Gripping the wide sides can damage the contacts inside the jumper, causing intermittent problems with the function controlled by that jumper. Take care to grip with, but not squeeze, the pliers or other tool you use to remove a jumper, or you may bend or break the pins on the board.

Preface

About this Manual

Thank you for purchasing and using the Intel® Server Board S5520HC/S5520HCT/S5500HCV.

When a feature varies from the Intel® Server Board S5520HC/S5520HCT to the Intel® Server Board S5500HCV, the difference is noted in this document. Unless specified, features apply to both the Intel® Server Board S5520HC/S5520HCT and Intel® Server Board S5500HCV.

This manual is written for system technicians responsible for troubleshooting, upgrading, and repairing this server board. This document provides a brief overview of the features of the board/chassis, list of accessories or other components you may need, troubleshooting information, and instructions on how to add and replace components on the Intel® Server Board S5520HC /S5520HCT/S5500HCV. For the latest version of this manual, refer to: <http://support.intel.com/support/motherboards/server/S5520HC/>

Manual Organization

Chapter 1 provides a brief overview of the Intel® Server Board S5520HC /S5520HCT/S5500HCV. In this chapter, you will find a list of the server board features, photos of the product, and product diagrams to help you identify components and their locations.

Chapter 2 provides instructions on using the utilities shipped with the board or that may be required to update the system. This includes how to navigate through the BIOS setup screen, perform a BIOS update, and reset the password or CMOS. Information about the specific BIOS settings and screens is available in the Technical Product Specification. See “[Additional Information and Software](#)” for a link to the Technical Product Specification.

Chapter 3 provides instructions on adding and replacing components. Use this chapter for step-by-step instructions and diagrams for installing or replacing components such as the memory, processor, front panel board, and battery, among other components.

Chapter 4 provides troubleshooting information. In this chapter, you will find BIOS error messages and POST code messages. You will also find suggestions for performing troubleshooting activities to identify the source of a problem.

Product Accessories

The Intel® Server Board S5520HC, S5520HCT and S5500HCV are compatible with the following Intel® Server Chassis:

- Intel® Server Chassis SC5600Base
- Intel® Server Chassis SC5600BRP
- Intel® Server Chassis SC5600LX
- Intel® Server Chassis SC5650DP
- Intel® Server Chassis SC5650BRP

NOTE

When installing either the Intel® Server Board S5520HC/S5520HCT or S5500HCV in the Intel® Server Chassis SC5600LX, a passive processor heatsink (FXXRGTHSINK) is required.

The Intel® Server Board S5520HC/S5520HCT and S5500HCV are compatible with the following Intel® hot-swap hard disk drive backplane assemblies:

- AXX6DRV3GR
- AXX4DRV3GR
- AXX6DRV3GEXP
- AXX4DRV3GEXP

You may need or want to purchase one or more of the following accessory items for your server:

- Processor
- Memory DIMMs
- Hard drive
- USB floppy drive
- CD-ROM or DVD-ROM drive
- RAID controller
- Operating System

For information about which accessories, memory, processors, and third-party hardware were tested and can be used with your board, and for ordering information for Intel products, see:

<http://support.intel.com/support/motherboards/server/S5520HC/compat.htm>.

Additional Information and Software

If you need more information about this product or information about the accessories you can use with this server board, use the following resources. These files are available at:

<http://support.intel.com/support/motherboards/server/S5520HC/>.

Preface

For this information or software	Use this Document or Software
For in-depth technical information about this product, including BIOS settings and chipset information	<p>Intel® Server Board S5520HC/S5520HCT and S5500HCV Technical Product Specification.</p> <p>Available at: http://support.intel.com/support/motherboards/server/S5520HC/ See the section on the web page titled, “Technical Specifications”.</p>
If you just received this product and you need to assemble your system and install components	<p>Intel® Server Board S5520HC, S5520HCT, S5500HCV Quick Start User’s Guide in the product box.</p> <p>Or visit: http://support.intel.com/support/motherboards/server/S5520HC/ See the section on the web page titled, “Installation and Use”.</p>
Accessories or other Intel® server products	<p>Spares and Configuration Guide.</p> <p>Available at: http://support.intel.com/support/motherboards/server/S5520HC/ See the section on the web page titled, “Installation and Use” or using the Server Configurator Tool described in the next box.</p>
To quickly and efficiently select compatible components to design a complete system	<p>Intel® Server Configurator tool</p> <p>Available at: http://serverconfigurator.intel.com/default.aspx</p>
<p>Hardware (peripheral boards, adapter cards, and so on) and operating systems tested with this product</p> <p>Processors tested with this product</p> <p>DIMMs tested with this product</p> <p>Hard Drives tested with this product</p>	<p>Server Configurator Tool</p> <p>Available at: http://serverconfigurator.intel.com/default.aspx</p>
Chassis tested with this product	<p>Reference Chassis List.</p> <p>Available at: http://support.intel.com/support/motherboards/server/S5520HC/ See the section on the web page titled, “Compatibility”.</p>
To make sure your system falls within the allowed power budget	<p>Power Budget Analysis Tool.</p> <p>Available at: http://support.intel.com/support/motherboards/server/S5520HC/ See the section on the web page titled, “Installation and Use”.</p>
For latest drivers, firmware updates (BIOS, BMC, FRUSDR, and ME), and utilities	<p>Available for download at: http://support.intel.com/support/motherboards/server/S5520HC/ Click the “Software and Drivers” link on the left side of the web page</p>
For software to manage your Intel® server	<p>Intel System Management Software.</p> <p>Available at: http://www.intel.com/go/servermanagement</p>

Contents

Safety Information	iii
Preface	vi
1 Server Board Features	1
Connector and Component Locations.....	4
Configuration Jumpers.....	5
Back Panel Features	6
Intel® Light-Guided Diagnostics.....	7
RAID Support.....	8
Hardware Requirements.....	9
Processor	9
Memory	9
Power Supply	11
Storage Mode Matrix	12
Optional Hardware.....	14
Intel® SAS Entry RAID Module AXX4SASMOD	14
2 System Utilities	17
Using the BIOS Setup Utility.....	17
Starting Setup	17
If You Cannot Access Setup.....	17
Setup Menus.....	17
Upgrading the BIOS.....	18
Preparing for the Upgrade	19
Recovering the BIOS	20
Clearing the Password.....	21
Clearing the CMOS.....	23
3 Hardware Installations and Upgrades	24
Before You Begin.....	24
Tools and Supplies Needed	24
Installing and Removing Memory	24
Installing DIMMs	24
Removing DIMMs	25
Installing or Replacing the Processor.....	25
Installing the Processor	25
Installing the Processor Heatsink(s).....	28
Replacing the Processor.....	31
Replacing the CMOS Battery	31
4 Troubleshooting	34
Resetting the System.....	34
Problems following Initial System Installation	34
First Steps Checklist.....	34
Hardware Diagnostic Testing	35
Verifying Proper Operation of Key System Lights.....	35
Confirming Loading of the Operating System	35

Preface

Specific Problems and Corrective Actions	35
Power Light Does Not Light.....	36
No Characters Appear on Screen	36
Characters Are Distorted or Incorrect.....	37
System Cooling Fans Do Not Rotate Properly.....	37
CD-ROM Drive or DVD-ROM Drive Activity Light.....	38
Cannot Connect to a Server	38
Problems with Network	38
System Boots when Installing PCI Card.....	39
Problems with Newly Installed Application Software	39
Problems with Application Software that Ran Correctly Earlier.....	39
Devices are not Recognized under Device Manager (Microsoft Windows* Operating System)	40
Hard Drive(s) are not Recognized.....	40
Bootable CD-ROM/DVD-ROM Disk Is Not Detected	40
LED Information	40
BIOS POST Beep Codes.....	40
Appendix A: Regulatory and Compliance Information	42
Product Regulatory Compliance.....	42
Product Safety Compliance	42
Product EMC Compliance – Class A Compliance	42
Certifications/Registrations/Declarations	42
Product Regulatory Compliance Markings.....	43
Electromagnetic Compatibility Notices	43
FCC (USA)	43
ICES-003 (Canada)	44
Europe (CE Declaration of Conformity).....	44
VCCI (Japan)	44
BSMI (Taiwan)	45
RRL (Korea)	45
Product Ecology Change (EU RoHS).....	45
Product Ecology Change (CRoHS)	45
China Packaging Recycle Marks (or GB18455-2001)	48
CA Perchlorate Warning	48
End-of-Life/Product Recycling.....	48
Appendix B: Getting Help.....	49
Intel® Server Issue Report Form	50

Figures

Figure 1. Intel® Server Board S5520HC/S5520HCT	1
Figure 2. Intel® Server Board S5500HCV	1
Figure 3. Server Board Connector and Component Locations.....	4
Figure 4. Configuration Jumper Location	5
Figure 5. Back Panel Features	6
Figure 6. Intel® Light-Guided Diagnostics	8
Figure 7. DIMM Sockets	10
Figure 8. Intel® SAS Entry RAID Module.....	14
Figure 9. BIOS Recover Jumper	20
Figure 10. Password Clear Jumper.....	22
Figure 11. CMOS Clear Jumper	23
Figure 12. Installing Memory	24
Figure 13. Opening the Processor Socket Lever	26
Figure 14. Opening the Processor Socket Load Plate.....	26
Figure 15. Removing the Processor Socket Protective Cover	27
Figure 16. Remove Processor Protective Cover.....	27
Figure 17. Install the processor	27
Figure 18. Close Load Plate and Socket Lever.....	28
Figure 19. Installing Processor Heatsink(s)	30
Figure 20. Locating Active Heatsink Cable Connections.....	30
Figure 21. Locating and Removing the CMOS Battery.....	33

Tables

Table 1. Server Board Features	2
Table 2. Configuration Jumpers	5
Table 3. NIC LEDs	6
Table 4. Storage Mode Matrix	13
Table 5. Keyboard Commands.....	18
Table 6. Heatsink Requirements for Compatible Intel® Server Chassis.....	29
Table 7. POST Error Beep Codes.....	34
Table 8. BIOS POST Error Beep Codes	40
Table 9. BMC POST Error Beep Codes.....	41
Table 10. Product Certification Markings	43

1 Server Board Features

This chapter briefly describes the main features of the Intel® Server Board S5520HC/S5520HCT and Intel® Server Board S5500HCV. This chapter provides a photograph of the product, list of the server board features, and diagrams showing the location of important components and connections on the server board.

The Intel® Server Board S5520HC/S5520HCT and Intel® Server Board S5500HC are shown in the following pictures.



Figure 1. Intel® Server Board S5520HC/S5520HCT



Figure 2. Intel® Server Board S5500HCV

Table 1. Server Board Features

Feature	Description
Processors	<ul style="list-style-type: none"> ▪ Up to two Intel® Xeon® Processors 5500 series with Thermal Design Power (TDP) up to 95 W. ▪ Support for one or two Intel® Xeon® Processor(s) 5600 series up to 130W Thermal Design Power
Memory	<ul style="list-style-type: none"> ▪ Six memory channels (three channels per processor socket) with support for 800/1066/1333 MT/s ECC Registered (RDIMM) or ECC Unbuffered (UDIMM) DDR3 memory. ▪ No support for mixing of RDIMMs and UDIMMs. ▪ Mixing memory type, size, speed, and/or rank on this platform has not been validated and is not supported ▪ Mixing memory vendors is not supported on this platform by Intel ▪ Non-ECC memory is not supported and has not been validated in a server environment ▪ Intel® Server Board S5520HC/S5520HCT <ul style="list-style-type: none"> ○ 12 DIMM slots, two DIMM slots per channel ▪ Intel® Server Board S5500HCV <ul style="list-style-type: none"> ○ Nine DIMM slots. ○ Two DIMM slots on each channel of processor socket 1. ○ One DIMM slot on each channel of processor socket 2.
Chipset	<ul style="list-style-type: none"> ▪ Intel® Server Board S5520HC/S5520HCT <ul style="list-style-type: none"> ○ Intel® S5520 Chipset and Intel® 82801Jx I/O Controller Hub (ICH10R) ▪ Intel® Server Board S5500HCV <ul style="list-style-type: none"> ○ Intel® S5500 Chipset and Intel® 82801Jx I/O Controller Hub (ICH10R)
Cooling fan support	<p>Support for</p> <ul style="list-style-type: none"> ▪ Two processor fans (4-pin headers) ▪ Four front fans (6-pin headers) ▪ One rear fan (4-pin header) <p>3-pin fans are compatible with all fan headers.</p>
Add-in Card Slots	<ul style="list-style-type: none"> ▪ Intel® Server Board S5520HC/S5520HCT: Six expansion slots <ul style="list-style-type: none"> ○ One PCI Express* Gen 2 slot (x16 Mechanically, x8 Electrically) ○ Three PCI Express* Gen 2 x8 slots ○ One PCI Express* Gen 1 slot (x8 Mechanically, x4 Electrically) shared with SAS Module slot. This PCI Express* Gen 1 slot is not available when the SAS module slot is in use and vice versa ○ One 32-bit/33 MHz PCI slot, keying for 5 V and Universal PCI add-in card ▪ Intel® Server Board S5500HCV: Five expansion slots <ul style="list-style-type: none"> ○ One PCI Express* Gen 2 slot (x16 Mechanically, x4 Electrically) ○ Two PCI Express* Express* Gen 2 x8 slots ○ One PCI Express* Gen 1 slot (x8 Mechanically, x4 Electrically) shared with SAS Module slot. This PCI Express* Gen 1 slot is not available when the SAS module slot is in use and vice versa ○ One 32-bit/33 MHz PCI slot, keying for 5 V and Universal PCI add-in card

Feature	Description
Video Support	<ul style="list-style-type: none"> ▪ Server Engine* LLC Pilot II* with 64 MB DDR2 memory, 8 MB allocated to graphics ▪ Dual video is supported
Hard Drive and Optical Drive Support	<ul style="list-style-type: none"> ▪ Optical devices are supported ▪ Six SATA connectors at 1.5 Gbps and 3 Gbps ▪ Four SAS connectors at 3 Gbps through optional Intel® SAS Entry RAID Module AXX4SASMOD
USB Drive Support	<ul style="list-style-type: none"> ▪ One internal USB port ▪ One internal low-profile USB port for Solid State Drive
I/O control support	<ul style="list-style-type: none"> ▪ External connections: <ul style="list-style-type: none"> ○ DB9 serial port A connection ○ One DH 10 serial port connector (optional) ○ Two RJ-45 NIC connectors for 10/100/1000 Mb connections: Dual GbE through the Intel® 82575EB Network Connection with Intel® I/O Acceleration Technology 2 support ○ Four USB 2.0 ports at the back of the board ▪ Internal connections: <ul style="list-style-type: none"> ○ Two 9-pin USB headers, each supports two USB 2.0 ports ○ One internal USB port that supports a peripheral, such as a floppy drive ○ One DH10 serial port B header ○ Six SATA connectors at 1.5 Gbps and 3 Gbps ○ Four SAS connectors at 3 Gbps (optional) ○ One SSI-compliant 24-pin front control panel header
RAID Support	<ul style="list-style-type: none"> ▪ Intel® Embedded Server RAID Technology II through on-board SATA connectors provides SATA RAID 0, 1, and 10 with optional RAID 5 support provided by the Intel® RAID Activation Key AXXRAKSW5 ▪ Intel® Embedded Server RAID Technology II through optional Intel® SAS Entry RAID Module AXX4SASMOD provides SAS RAID 0, 1, and 10 with optional RAID 5 support provided by the Intel® RAID Activation Key AXXRAKSW5 ▪ IT/IR RAID through optional Intel® SAS Entry RAID Module AXX4SASMOD provides entry hardware RAID 0, 1, 10/10E, and Native SAS pass through mode ▪ Four ports with fully featured SAS/SATA hardware RAID through optional Intel® Integrated RAID Module SROMBSASMR (AXXROMBSASMR) provides RAID 0, 1, 5, 6, and striping capability for spans 10, 50, 60.
Management support	<ul style="list-style-type: none"> ▪ Integrated IPMI 2.0 compliant Baseboard Management Controller ▪ Support for the Intel® Local Control Panel (optional component sold separately) ▪ Support for Intel® Remote Management Module 3 ▪ Support for Intel® System Management Software ▪ Intel® Light-Guided Diagnostics on field replaceable units

Connector and Component Locations

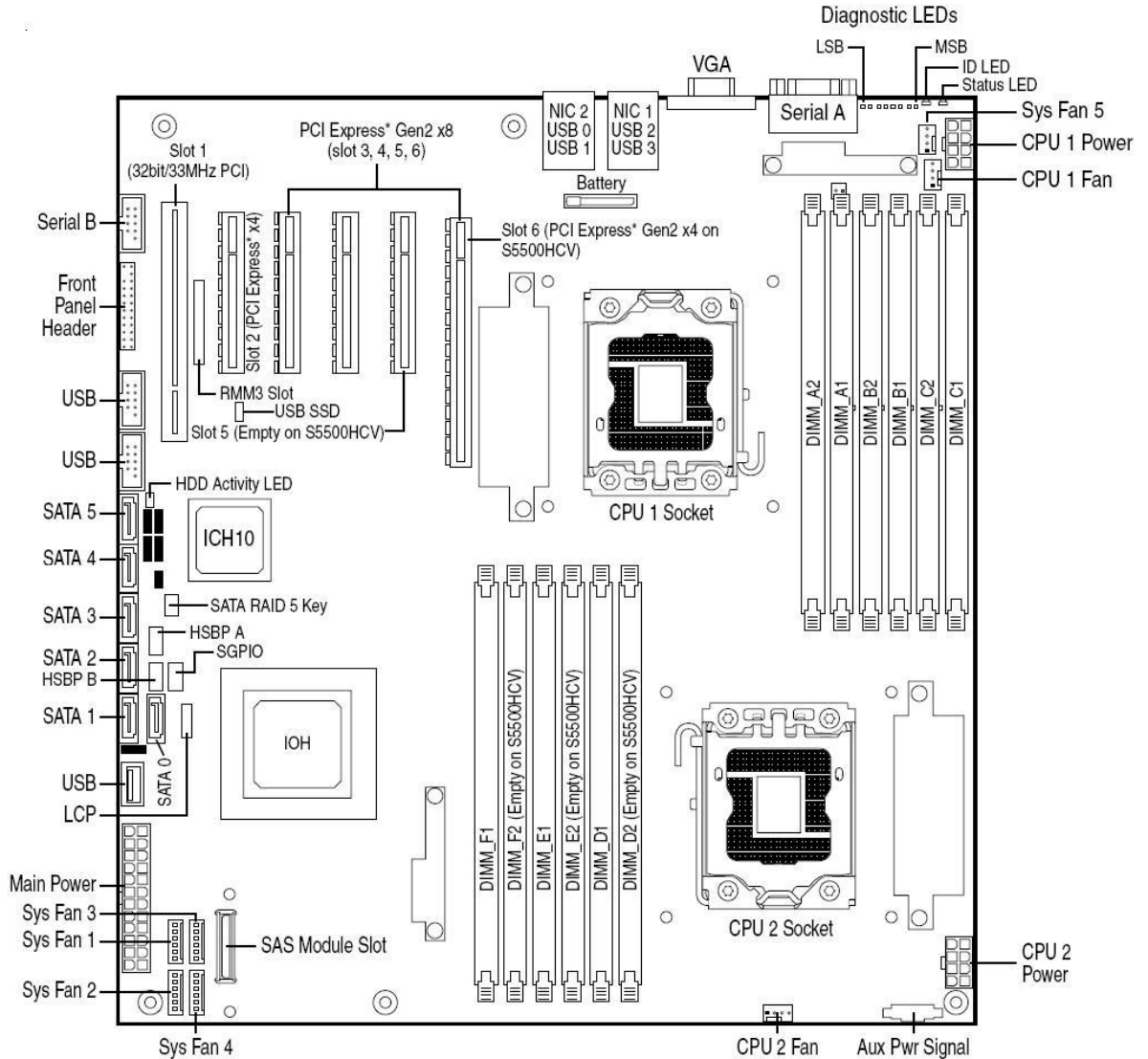

Figure 3. Server Board Connector and Component Locations

Configuration Jumpers

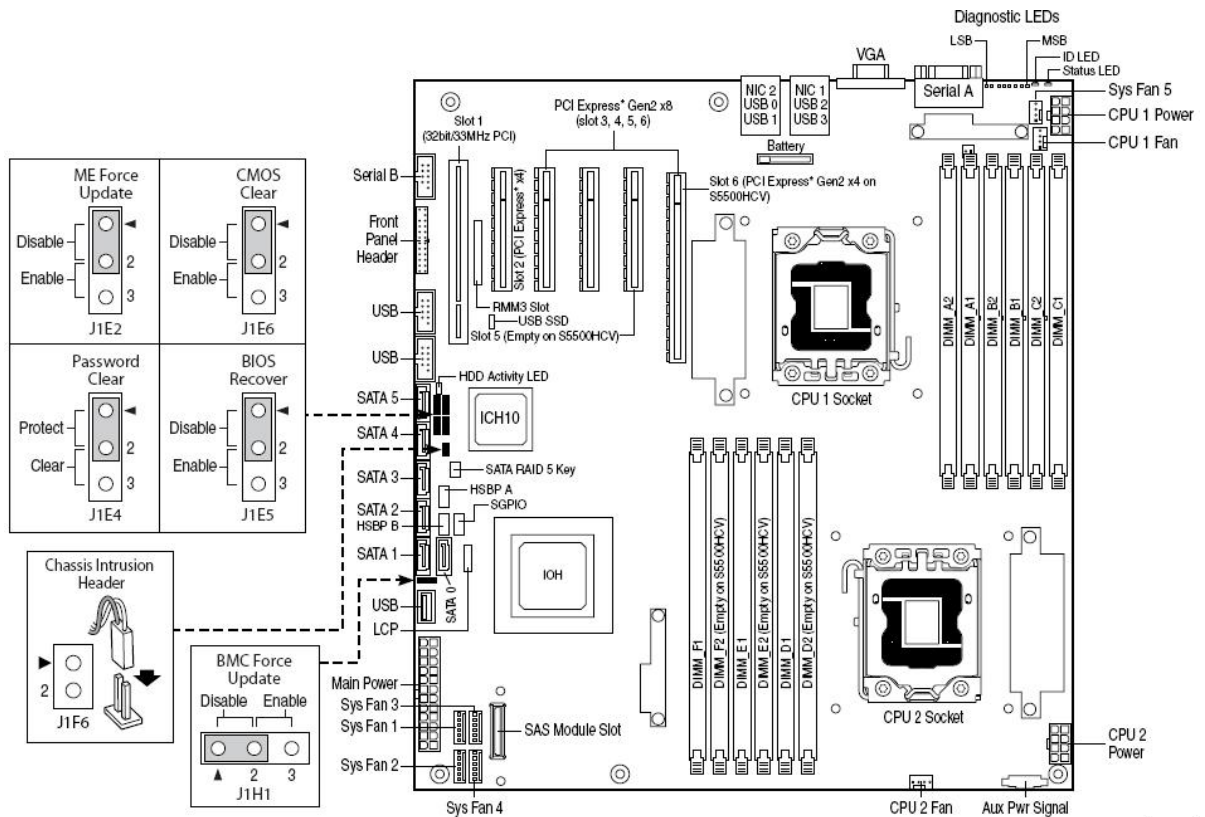

Figure 4. Configuration Jumper Location

Table 2. Configuration Jumpers

Jumper Name	Pins	What happens at system reset
CMOS Clear (J1E6)	1-2 (Default)	Protect CMOS: These pins should have a jumper in place for normal system operation.
	2-3	If pins 2-3 are connected for 5 to 10 seconds with AC power unplugged, the CMOS settings clear on the next reset. These pins should not be connected for normal operation.
ME Force Update (J1E2)	1-2 (Default)	ME Firmware Force Update Mode – Disabled These pins should have a jumper in place for normal system operation.
	2-3	ME Firmware Force Update Mode – Enabled These pins should not be connected for normal operation.
Password Clear (J1E4)	1-2 (Default)	Protect Password: These pins should have a jumper in place for normal system operation.
	2-3	To clear administrator and user passwords, power on the system with pins 2-3 connected. The administrator and user passwords clear in 5-10 seconds after power on. These pin should not be connected for normal system operation.
BIOS Recover (J1E5)	1-2 (Default)	These pins should be connected for normal system operation.
	2-3	The main system BIOS does not boot with pins 2-3 connected. The system only boots from EFI-bootable recovery media with a recovery BIOS image present. These pin should not be connected for normal system operation.

Server Board Features

Jumper Name	Pins	What happens at system reset
BMC Force Update (J1H1)	1-2 (Default)	BMC Firmware Force Update Mode – Disabled. These pins should have a jumper in place for normal system operation.
	2-3	BMC Firmware Force Update Mode – Enabled. These pins should not be connected for normal operation.

Back Panel Features

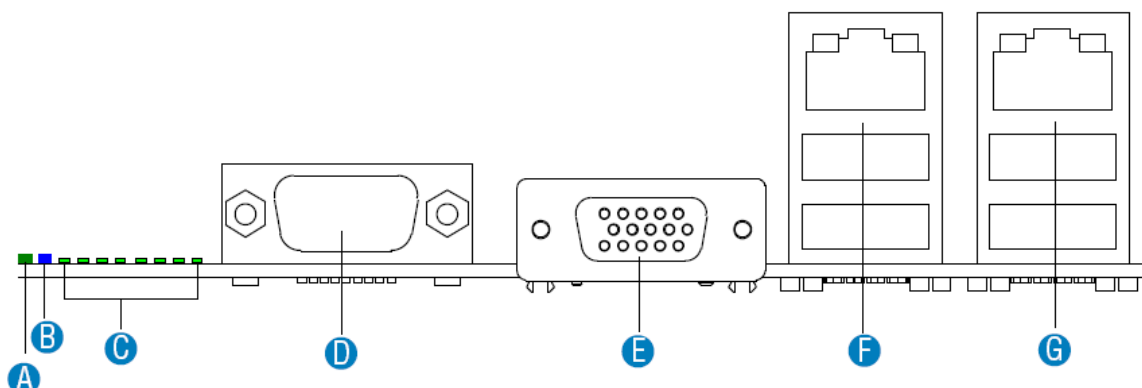

- A. System Status LED
- B. ID LED
- C. POST Diagnostic LEDs
- D. Serial A Port
- E. Video
- F. NIC 1 (top, default management port), Two USB (bottom)
- G. NIC 2 (top), Two USB (bottom)

Figure 5. Back Panel Features

The NIC LEDs at the right and left of each NIC provide the following information:

Table 3. NIC LEDs

NIC	LED Color	LED State	Description
NIC 1 and NIC 2 (Gigabit)	Left LED	Off	No network connection
		Blinking Green	Transmit/receive activity
	Right LED	Off	10 Mbps connection (if left LED is on or blinking)
		Solid Green	100 Mbps connection
		Solid Amber	1000 Mbps connection

Intel® Light-Guided Diagnostics

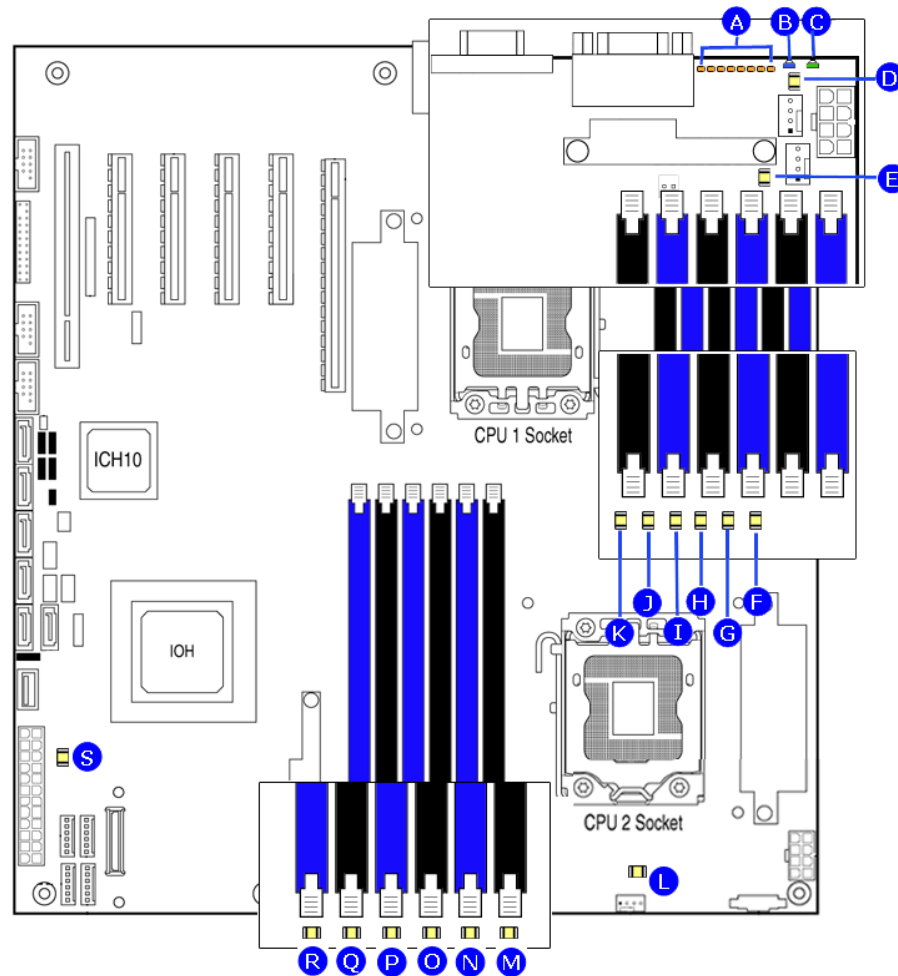

Callout	LED	Functions
A.	POST Diagnostics LEDs	POST Diagnostics LEDs: The sequence of lit POST Diagnostics LEDs is used to identify specific errors that might occur during the boot process. For a description of how to read these LEDs, refer to the appendix of the Technical Product Specification.
B.	ID LED	You can turn this LED on and off by pressing a chassis button or by using system management software. This LED is useful when the system is grouped with several systems, such as in a rack, and you need to find the system to perform maintenance on it.
C.	System Status LED	The status LED indicates whether a system is operating correctly, has experienced a minor fault, or a major system error. For details about this LED, refer to the Technical Production Specification.
D.	System fan 5 fault LED	This LED indicates a fault occurred with a fan installed on the Server Board System Fan 5 header. Replace the faulty unit.
E.	Processor 1 fan fault LED	This LED applies only to server systems that use an active heatsink. This LED indicates a fault occurred with the fan installed on the heatsink for processor 1. Replace faulty unit.
F.	DIMM C1 fault LED	This LED indicates a fault occurred with the DIMM installed in socket DIMM_C1.

Server Board Features

Callout	LED	Functions
		Replace the faulty DIMM.
G.	DIMM C2 fault LED	This LED indicates a fault occurred with the DIMM installed in socket DIMM_C2. Replace the faulty DIMM.
H.	DIMM B1 fault LED	This LED indicates a fault occurred with the DIMM installed in socket DIMM_B1. Replace the faulty DIMM.
I.	DIMM B2 fault LED	This LED indicates a fault occurred with the DIMM installed in socket DIMM_B2. Replace the faulty DIMM.
J.	DIMM A1 fault LED	This LED indicates a fault occurred with the DIMM installed in socket DIMM_A1. Replace the faulty DIMM.
K.	DIMM A2 fault LED	This LED indicates a fault occurred with the DIMM installed in socket DIMM_A2. Replace the faulty DIMM.
L.	Processor 2 fan fault LED	This LED applies only to server systems that use an active heatsink. This LED indicates a fault occurred with a fan installed on the heatsink for processor 2. Replace faulty unit.
M.	DIMM D2 fault LED (Empty in S5500HCV)	This LED indicates a fault occurred with the DIMM installed in socket DIMM_D2. Replace the faulty DIMM.
N.	DIMM D1 fault LED	This LED indicates a fault occurred with the DIMM installed in socket DIMM_D1. Replace the faulty DIMM.
O.	DIMM E2 fault LED (Empty in S5500HCV)	This LED indicates a fault has occurred with the DIMM installed in socket DIMM_E2. Replace the faulty DIMM.
P.	DIMM E1 fault LED	This LED indicates a fault occurred with the DIMM installed in socket DIMM_E1. Replace the faulty DIMM.
Q.	DIMM F2 fault LED (Empty in S5500HCV)	This LED indicates a fault occurred with the DIMM installed in socket DIMM_F2. Replace the faulty DIMM.
R.	DIMM F1 fault LED	This LED indicates a fault occurred with the DIMM installed in socket DIMM_F1. Replace the faulty DIMM.
S.	+5-V Standby LED	This LED is green whenever AC power is applied to the system. You do not need to power on the system for this LED to be on.

Figure 6. Intel® Light-Guided Diagnostics

RAID Support

The Intel® Server Board S5520HC/S5500HCV provide an embedded SATA controller that supports both 1.5 Gbps and 3.0 Gbps data transfer rates.

The BIOS Setup Utility provides drive configuration options on the Advanced | Mass Storage Controller Configuration setup page, some of which affect the ability to configure RAID. The “On-board SATA Controller” option is enabled by default and when enabled, you can set the “SATA Mode” option to either one of the following four modes:

- “Enhanced” – Enhanced Mode supports up to six SATA ports with IDE native Mode.
- “Compatibility” – Supports up to four SATA ports [0/1/2/3] with IDE Legacy mode and two SATA ports [4/5] with IDE Native Mode.
- “AHCI” – Supports all SATA ports using the Advanced Host Controller Interface.
- “SW RAID” – Intel® Embedded Server RAID Technology II is enabled by “SW RAID” mode. The Intel® Embedded Server RAID Technology II feature provides RAID modes 0, 1, and 10.

If RAID 5 is needed, you must install the optional Intel® RAID Activation Key AXXRAKSW5 accessory. This activation key is placed on the SATA_RAID_5_Key connector located on the left side of the server board. For installation instructions, see the documentation included with the activation key.

When Intel® Embedded Server RAID Technology II is enabled with the embedded SATA controller, enclosure management is provided through the SATA_SGPIO connector on the server board when a cable is attached between this connector and the backplane or I²C interface.

NOTE

For help with navigating the BIOS Setup utility, see the Intel® Server Board S5520HC/S5500HCV Technical Product Specification.

For information on how to configure RAID, refer to the RAID software user's guide at:

<http://www.intel.com/support/motherboards/server/S5520HC/howto.htm>

For help with enclosure management cabling, refer to the Enclosure Management Cabling Guide for Pedestal Systems with hot-swap Drive Backplanes. This guide is available at:

<http://support.intel.com/support/motherboards/server/S5520HC/compat.htm>

Hardware Requirements

To avoid integration difficulties and possible board damage, your system must meet the following requirements outlined. For a list of qualified components, see the links under “[Additional Information and Software](#)”.

Processor

One or two Intel® Xeon® Processor 5500 series or Intel® Xeon® Processor 5600 series

For a list of supported processors, see the links under “[Additional Information and Software](#)”.

You must populate processors in sequential order. Therefore, you must populate Processor Socket 1 (CPU 1) before processor socket 2 (CPU 2).

For optimum performance, when two processors are installed, both must be the identical revision and have the same core voltage and Intel® QPI/Core speed.

Memory

The Intel® Server Board S5520HC/S5520HCT provides 12 DIMM sockets in six channels. Each channel contains two DIMM sockets:

- Channel A contains DIMM sockets A1 and A2
- Channel B contains DIMM sockets B1 and B2
- Channel C contains DIMM sockets C1 and C2
- Channel D contains DIMM sockets D1 and D2
- Channel E contains DIMM sockets E1 and E2
- Channel F contains DIMM sockets F1 and F2

The Intel® Server Board S5520HCV provides nine DIMM sockets in six channels. Channels A, B, and C contain two DIMM sockets per channel. Channels D, E, and F contain one DIMM socket per channel:

- Channel A contains DIMM sockets A1 and A2
- Channel B contains DIMM sockets B1 and B2

Server Board Features

- Channel C contains DIMM sockets C1 and C2
- Channel D contains DIMM sockets D1
- Channel E contains DIMM sockets E1
- Channel F contains DIMM sockets F1

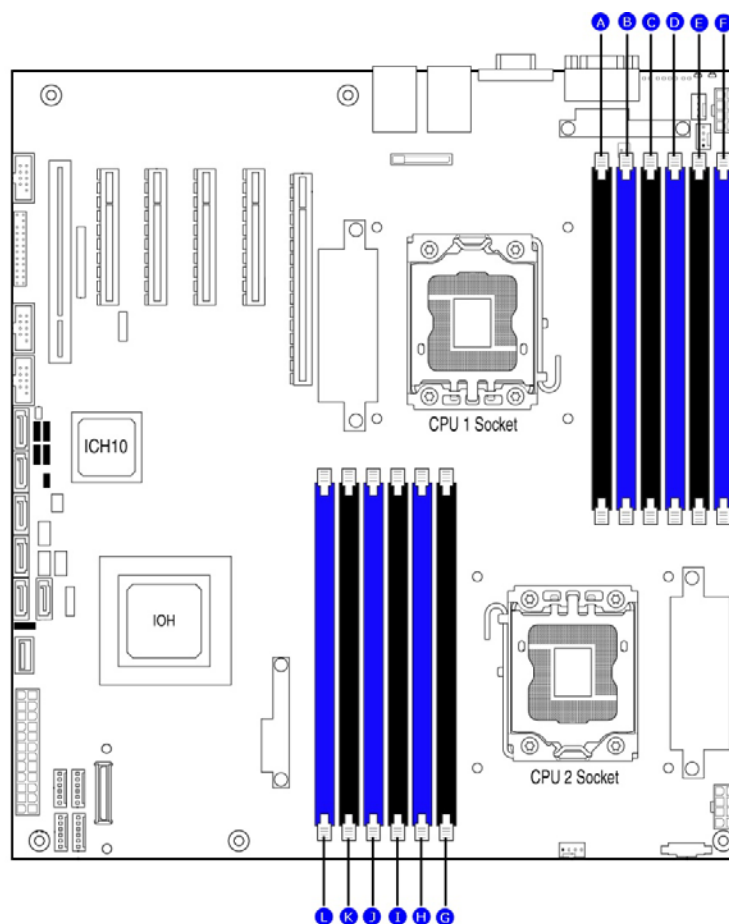

Callout	DIMM Socket	Callout	DIMM Socket
A.	Channel A, DIMM_A2	G.	Channel D, DIMM_D2 (Empty on S5500HCV)
B.	Channel A, DIMM_A1 (Blue)	H.	Channel D, DIMM_D1 (Blue)
C.	Channel B, DIMM_B2	I.	Channel E, DIMM_E2 (Empty on S5500HCV)
D.	Channel B, DIMM_B1 (Blue)	J.	Channel E, DIMM_E1 (Blue)
E.	Channel C, DIMM_C2	K.	Channel F, DIMM_F2 (Empty on S5500HCV)
F.	Channel C, DIMM_C1 (Blue)	L.	Channel F, DIMM_F1 (Blue)

Figure 7. DIMM Sockets

DDR3 DIMMs must meet the following requirements:

- Use only 240-pin DDR3 DIMMs.
- A minimum of one 1 GB DDR3 DIMM is required in DIMM socket DIMM_A1.
- Either registered DDR3 DIMMs (RDIMMs) or ECC unbuffered DDR3 DIMMs (UDIMMs). No mixing of RDIMMs and UDIMMs.

- Mixing memory type, size, speed, and/or rank on this platform has not been validated and is not supported
- Mixing memory vendors is not supported on this platform by Intel
- Non-ECC memory is not supported and has not been validated in a server environment
- DDR3-800, DDR3-1066, or DDR3-1333
- DIMM within a channel must be populated starting with the first slot (blue slot) of the channel: DIMM_A1, DIMM_B1, DIMM_C1, DIMM_D1, DIMM_E1, or DIMM_F1.
- When installing Quad-rank DIMM, you must populate Quad-rank DIMM starting with the first slot (blue slot) of each channel.

For a complete list of supported memory DIMMs, see the links under [“Additional Information and Software”](#).

Channel Population Requirements for Memory RAS Modes

The Intel® Server Board S5520HC /S5520HCT/S5500HCV support two memory RAS modes: Independent Channel Mode, and Mirrored Channel Mode. The rules on channel population and channel matching vary by the RAS mode used. Note that the support of RAS modes that require matching DIMM population between channels (Mirroring) and require that ECC DIMMs must be populated.

Independent Channel Mode

You can populate channels in any order in Independent Channel Mode. You can populate all three channels in any order and have no matching requirements. All channels must run at the same interface frequency, but individual channels may run at different DIMM timings (RAS latency, CAS latency, and so on).

Mirrored Channel Mode

In Mirrored Channel Mode, the memory contents are mirrored between Channels A (D) and Channel B (E). As a result of the mirroring, the total physical memory available to the system is half of what is populated. Mirrored Channel Mode requires that Channel A (D) and Channel B (E) must be populated identically. DIMM slot populations within a channel do not have to be identical but the same DIMM slot location across Channel A (D) and Channel B (E) must be populated the same. Channel C (F) is unused in Mirrored Channel Mode.

NOTE

For help with memory population rules, refer to the Intel® Server Board S5520HC/S5520HCT/S5500HCV Technical Product Specification.

Power Supply

A minimum of 550 W is recommended, or decide your system power supply capacity using the Intel® Power Budget Tool. Your supply must provide a minimum of 3 amps of 5-V standby current or the board will not boot.

Storage Mode Matrix

SW RAID = Intel® Embedded Server RAID Technology II (ESRTII)

IT/IR RAID = IT/IR RAID, Entry Hardware RAID

Storage Controller	Storage Mode	Description	RAID Types and Levels Supported	Driver	RAID Management Software	RAID Software User's Guide	Compatible Backplane
Onboard SATA Controller (ICH10R)	Enhanced	6 SATA ports at Native mode	N/A	Chipset driver or operating system embedded Broad OS support	N/A	N/A	AXX6DRV3GR, AXX4DRV3GR
	Compatibility	6 SATA ports: port 0, 1, 2, 3 at IDE Legacy mode, port 4, 5 at Native mode	N/A	Chipset driver or operating system embedded Broad OS Support	N/A	N/A	
	AHCI	6 SATA ports using the Advanced Host Controller Interface	N/A	AHCI driver or OS embedded Broad OS Support	N/A	N/A	
	SW RAID	6 SATA Ports	SW RAID 0/1/10 standard SW RAID 5 with optional AXXRAKSW5	ESRTII Driver Microsoft Windows* and selected Linux* Versions only	Intel® RAID Web Console 2	Intel® RAID Software User's Guide	

Storage Controller	Storage Mode	Description	RAID Types and Levels Supported	Driver	RAID Management Software	RAID Software User's Guide	Compatible Backplane
Optional Intel® SAS Entry RAID module AXX4SASMOD	IT/IR RAID	4 SAS Ports Up to 10 SAS or SATA drives via expander backplanes	Native SAS pass through mode without RAID function. Entry Hardware RAID. - RAID 1 (IM mode) - RAID 10/10E (IME mode) - RAID 0 (IS Mode)	SAS MPT driver (Fully open-source driver) Broad OS support.	Intel® RAID Web Console 2	IT/IR RAID Software User's Guide	AXX6DRV3GR AXX4DRV3GR AXX6DRV3GEXP AXX4DRV3GEXP
	SW RAID	4 SAS Ports Up to 8 SAS or SATA drives via expander backplanes	SW RAID 0/1/10 standard SW RAID 5 with optional AXXRAKSW5 Microsoft Windows* and selected Linux* Versions only	ESRTII Driver	Intel® RAID Web Console 2	Intel® RAID Software User's Guide	

Table 4. Storage Mode Matrix

Optional Hardware

Intel® SAS Entry RAID Module AXX4SASMOD

The Intel® Server Board S5520HC/S5520HCT/S5500HCV provide a SAS module slot (J2J1) for the installation of an optional Intel® SAS Entry RAID Module AXX4SASMOD. Once the optional Intel® SAS Entry RAID Module AXX4SASMOD is present, the x4 PCI Express* links from the ICH10R to PCI Express* Slot 2 (x8 mechanically, x4 electrically) switches to the SAS module slot.

The optional Intel® SAS Entry RAID Module AXX4SASMOD includes a SAS1064e controller that supports x4 PCI Express* link widths and is a single-function PCI Express* end-point device. The SAS controller supports the SAS protocol as described in the Serial Attached SCSI (SAS) Standard, version 1.0, and also supports SAS 1.1 features. A 32-bit external memory bus off the SAS1064e controller provides an interface for Flash ROM and NVSRAM (Non-volatile Static Random Access Memory) devices.

The optional Intel® SAS Entry RAID Module AXX4SASMOD provides four SAS connectors that support up to four hard drives with a non-expander backplane or up to eight hard drives with an expander backplane.

The optional Intel® SAS Entry RAID Module AXX4SASMOD also provides a SGPIO (Serial General Purpose Input/Output) connector and a SCSI Enclosure Services (SES) connector for backplane drive LED control.

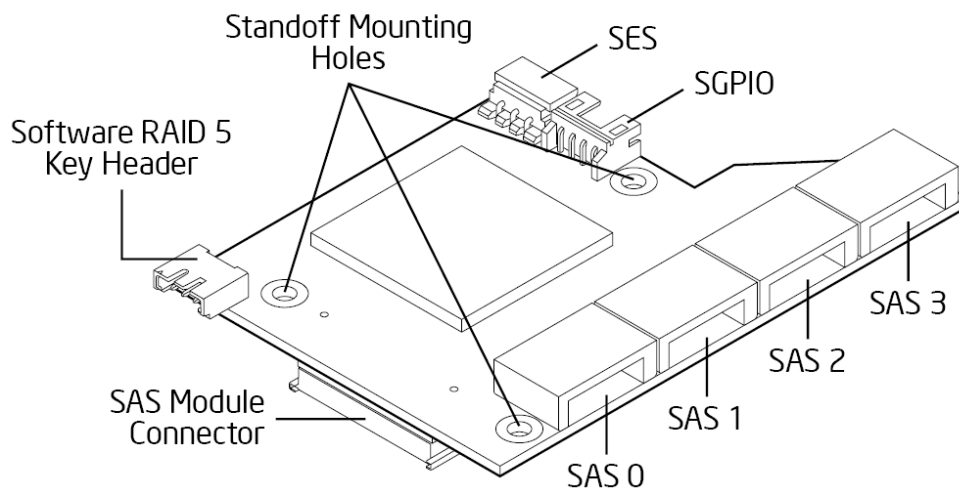

Figure 8. Intel® SAS Entry RAID Module

SAS RAID Support

The BIOS Setup Utility provides drive configuration options on the Advanced | Mass Storage Controller Configuration setup page for the Intel® SAS Entry RAID Module AXX4SASMOD, some of which affect the ability to configure RAID.

The “Intel® SAS Entry RAID Module” option is enabled by default once the Intel® SAS Entry RAID Module AXX4SASMOD is present. When enabled, you can set the “Configure Intel® SAS Entry RAID Module” to either “LSI* Integrated RAID” or “Intel® ESRTII” mode.

IT/IR RAID Mode

Supports entry hardware RAID 0, RAID 1, and RAID10/10E and native SAS pass through mode.

Intel® ESRTII Mode

The Intel® Embedded Server RAID Technology II (Intel® ESRTII) feature provides RAID modes 0, 1, and 10. If RAID 5 is needed with Intel® ESRTII, you must install the optional Intel® RAID Activation Key AXXRAKSW5 accessory. This activation key is placed on the SAS Software RAID 5 connector located on the Intel® SAS Entry RAID Module AXX4SASMOD. For installation instructions, see the documentation included with the SAS Module AXX4SASMOD and the activation key.

When Intel® Embedded Server RAID Technology II is enabled with the SAS Module AXX4SASMOD, enclosure management is provided through the SAS_SGPIO or SES connector on the SAS Module AXX4SASMOD when a cable is attached between this connector and the backplane or I²C interface.

NOTE

For help with navigating the BIOS Setup utility, refer to the Intel® Server Board S5520HC/S5520HCT/S5500HCV Technical Product Specification.

For information on how to configure RAID, see the RAID software user's guide at:
<http://www.intel.com/support/motherboards/server/S5520HC/howto.htm>

For information about configure IT/IR RAID, see the IT/IR RAID software user's guide at:
<http://www.intel.com/support/motherboards/server/S5520HC/howto.htm>

For help with enclosure management cabling, see the Enclosure Management Cabling Guide for Pedestal Systems with Hot-swap Drive Backplanes. This guide is available at:
<http://support.intel.com/support/motherboards/server/S5520HC/compat.htm>

Intel® RAID Activation Key

You can purchase and install the Intel® RAID Activation Key AXXRAKSW5 to enable Software RAID 5 support on your server board or the Intel® SAS Entry RAID Module AXX4SASMOD. For the Intel® Server Board S5520HC/S5520HCT/S5500HCV, you can install an Intel® RAID Activation Key (AXXRAKSW5) in the SATA RAID 5 Key connector. For the Intel® SAS Entry RAID Module AXX4SASMOD, you can install an Intel® RAID Activation Key (AXXRAKSW5) in the SAS RAID 5 key connector of the SAS module card.

Hard Disk Drives

The Intel® Server Board S5520HC/S5520HCT/S5500HCV support different hard disk driver options.

- USB or Serial SATA (SATA) Solid State Drives
- Serial SATA (SATA) and Serial Attached SCSI (SAS):
 - Supports for SATA Hard Disk Drive: Six on-board SATA ports at 1.5 Gbps and 3 Gbps.
 - Supports for SAS or SATA Hard Disk Drives: Four SAS ports via optional Intel® SAS Entry RAID Module AXX4SASMOD at 1.5 Gbps (SATA) and 3 Gbps (SATA and SAS).

NOTE

Refer to the documentation included with your server chassis for additional information and drive installation instructions.

Server Board Features

Tower Passive Heatsink (FXXRGTHSINK)

This tower passive heatsink (FXXRGTHSINK) is required when installing the Intel® Server Board S5520HC/S5520HCT/S5500HCV into the Intel® Server Chassis SC5600LX. Two tower heatsinks are required for dual-processor installation.

This tower passive heatsink is NOT required for other Intel® Server Chassis in the Intel® Server Chassis SC5600 and Intel® Server Chassis SC5650 families.

Intel® Remote Management Module 3

The Intel® Remote Management Module 3 (RMM3) plugs into the connector on the server board and acts as a component of the server board, and provides a way to view and operate the server remotely in real-time. Keyboard, video, and mouse control (KVM) is redirected to a managing system. This provides remote control. USB media redirection allows you to use a USB device anywhere on the network as if it was installed on the management server with RMM3 installed. For example, you can insert a CD-ROM disk in a workstation CD-ROM drive and the managed server views it as its own, local CD-ROM drive.

Intel® Local Control Panel

The Intel® Local Control Panel provides enhanced system control by using a LCD display, which provides additional controls and indicators beyond the standard control panel.

2 System Utilities

Using the BIOS Setup Utility

This section describes the BIOS Setup Utility options, which you use to change server configuration defaults. You can run the BIOS Setup with or without an operating system present. See [“Additional Information and Software”](#) for a link to the Technical Product Specification where you can find details about specific BIOS setup screens.

Starting Setup

You can enter and start BIOS Setup under several conditions:

- When you turn on the server, after POST completes the memory test.
- When you move the CMOS jumper on the server board to the “Clear CMOS” position (enabled).

In the two conditions listed above, after rebooting, you will see this prompt:

Press <F2> to enter SETUP

In a third condition, when CMOS/NVRAM is corrupted, you will see other prompts but not the <F2> prompt:

Warning: CMOS checksum invalid

Warning: CMOS time and date not set

In this condition, the BIOS loads the default values for CMOS and attempts to boot.

If You Cannot Access Setup

If you cannot access the BIOS Setup, you might need to clear the CMOS memory. For instructions on clearing the CMOS, see [“Clearing the CMOS”](#).

Setup Menus

Each BIOS Setup menu page contains a number of features. Except for those features provided only to display automatically configured information, each feature is associated with a value field that contains user-selectable parameters. If they have adequate security rights, a user can change these parameters. If a value cannot be changed for any reason, the feature’s value field is inaccessible.

Table 5 describes the keyboard commands you can use in the BIOS Setup menus.

Table 5. Keyboard Commands

Press	Description
<F1>	Help - Pressing F1 on any menu opens the general Help window.
← [®]	The left and right arrow keys are used to move between the major menu pages. The keys have no effect if a submenu or pick list is displayed.
↑	Select Item up - The up arrow is used to select the previous value in a menu item's option list, or a value field pick list. Pressing the Enter key activates the selected item.
↓	Select Item down - The down arrow is used to select the next value in a menu item's option list, or a value field pick list. Pressing the Enter key activates the selected item.
F5/-	Change Value - The minus key or the F5 function key is used to change the value of the current item to the previous value. This key scrolls through the values in the associated pick list without displaying the full list.
F6/+	Change Value - The plus key or the F6 function key is used to change the value of the current menu item to the next value. This key scrolls through the values in the associated pick list without displaying the full list. On 106-key Japanese keyboards, the plus key has a different scan code than the plus key on the other keyboard, but it has the same effect.
<Enter>	Execute Command - The Enter key is used to activate submenus when the selected feature is a submenu, or to display a pick list if a selected feature has a value field, or to select a sub-field for multi-valued features like time and date. If a pick list is displayed, the Enter key will undo the pick list, and allow another selection in the parent menu.
<Esc>	Exit - The ESC key provides a mechanism for backing out of any field. This key will undo the pressing of the Enter key. When the ESC key is pressed while editing any field or selecting features of a menu, the parent menu is re-entered. When the ESC key is pressed in any submenu, the parent menu is re-entered. When the ESC key is pressed in any major menu, the exit confirmation window is displayed and the user is asked whether they want to discard their changes.
<F9>	Setup Defaults - Pressing F9 causes the following to display: <p style="text-align: center;"><i>Setup Confirmation</i> <i>Load default configuration now?</i> <i>[Yes] [No]</i></p> If "Yes" is selected and the Enter key is pressed, all Setup fields are set to their default values. If "No" is selected and the Enter key is pressed, or if the ESC key is pressed, the user is returned to where they were before F9 was pressed without affecting any existing field values.
<F10>	Save and Exit - Pressing F10 causes the following message to display: <p style="text-align: center;"><i>Setup Confirmation</i> <i>Save Configuration changes and exit now?</i> <i>[Yes] [NO]</i></p> If "Yes" is selected and the Enter key is pressed, all changes are saved and Setup is exited. If "No" is selected and the Enter key is pressed, or if the ESC key is pressed, the user is returned to where they were before F10 was pressed without affecting any existing values.

Upgrading the BIOS

The upgrade utility allows you to upgrade the BIOS in flash memory. The code and data in the upgrade file include the following:

- On-board BIOS, including the recovery code, BIOS Setup Utility, and strings
- On-board video BIOS and other option ROMs for devices embedded on the server board
- OEM binary area
- Processor Microcode
- A way to change the BIOS language

- Option ROM of the Intel® Embedded Server RAID Technology II for on-board SATA

Preparing for the Upgrade

The following steps explain how to prepare to upgrade the BIOS and include how to:

- Record the current BIOS settings
- Obtain the upgrade utility
- Prepare a storage media for the utility

/ NOTE

In the unlikely event a BIOS error occurs during the BIOS update process, you may need to follow a recovery process to return the system to service. See [“Recovering the BIOS”](#) for instructions on performing a BIOS recovery.

Recording the Current BIOS Settings

1. Boot the computer and press <F2> when you see the message:
Press <F2> Key if you want to run SETUP
2. Write down the current settings in the BIOS Setup program or use the “Save and Store System Configuration Utility (SYSCFG)” to save the current settings into a file. See [“Additional Information and Software”](#) for a link to the utility and instructions.

/ NOTE

Do not skip Step 2. You need these settings to configure your computer at the end of the procedure.

Obtaining the Upgrade

Download the BIOS image file to a temporary folder on your hard drive. See [“Additional Information and Software”](#) for a link to the update software.

/ NOTE

Before attempting a BIOS upgrade, review the instructions distributed with the upgrade utility. Review also any release notes in the release notes file that accompanies the new version of the BIOS. The release notes may contain critical information regarding jumper settings, specific fixes, or other information to complete the upgrade.

Updating the BIOS

Follow the instructions in the readme file that came with the BIOS upgrade software package. When the updates complete, remove the storage media from which you performed the upgrade.



CAUTION

Do not power down the system during the BIOS update process!

/ **NOTE**

You may encounter a CMOS Checksum error or other problem after reboot. If this happens, shut down the system and boot it again. CMOS checksum errors require that you enter Setup, check your settings, save your settings, and exit Setup.

Recovering the BIOS

In the rare event the BIOS becomes damaged, you may need to follow a recovery process to return the system to service. To place the baseboard into recovery mode, move the BIOS Recover jumper (J1E5) located on the baseboard to the recovery position. The BIOS can then execute the recovery instead of the normal BIOS.

/ **NOTE**

The BIOS recovery is the mode of last resort; it is used only when the main system BIOS will not come up.

BIOS Recovery Procedure

1. Download the BIOS image file to a temporary folder on your hard drive. See [“Additional Information and Software”](#) for a link to the update software.
2. Copy all the files in the BIOS recovery package to the root directory of a USB disk-on-key device.
3. Power off the system.
4. Switch the BIOS recovery jumper (J1E5) to the “enabled” position (**ping 2-3**).

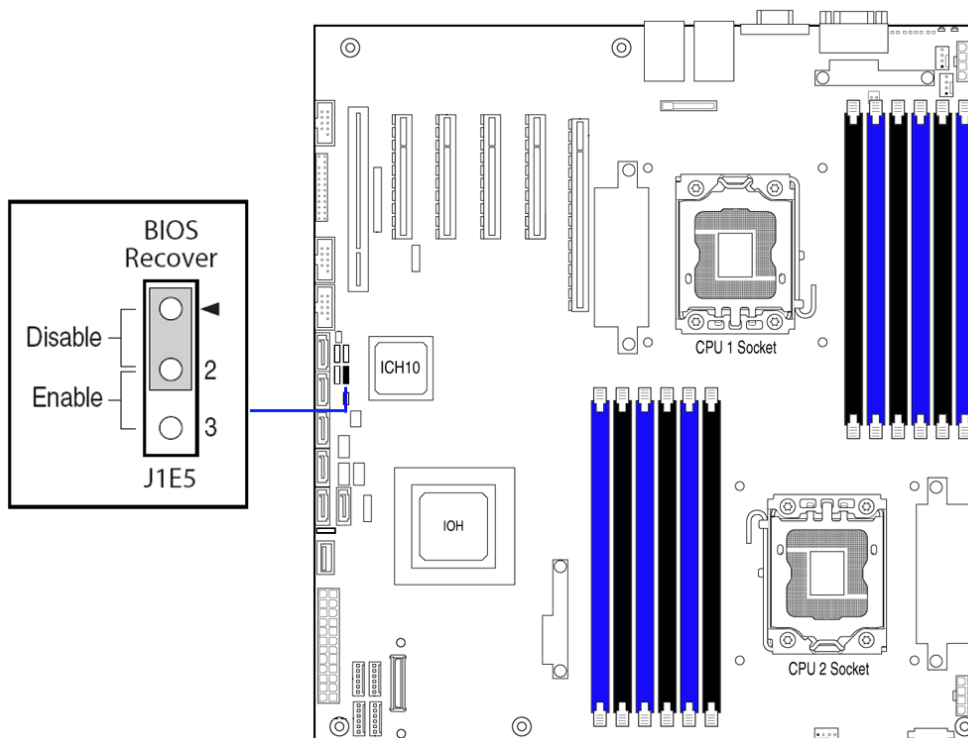

Figure 9. BIOS Recover Jumper

5. Insert the recovery media and confirm all the recovery files in the media.
6. Power on the system.
7. The BIOS POST screen will appear displaying the progress, and the system automatically boots to the EFI SHELL.
8. Startup.nsh file executes automatically, and initiates the BIOS update with the recovery BIOS capsule file. The message of the “BIOS has been updated successfully” displays once the recovery process is complete.
9. Power off the system and revert the BIOS recovery jumper position to the default (pin 1-2).
10. Power on the system.



CAUTION

DO NOT interrupt the BIOS POST during the first boot after recovery!

Clearing the Password

If the user or administrator password(s) is lost or forgotten, moving the password clear jumper into the “clear” position clears both passwords. You must restore the password clear jumper to its original position before you can set a new password(s). The password clear jumper is located on jumper block **J1E4**.

1. Power down the server. Do not disconnect the power cord.
2. Open the chassis. For instructions, see your server chassis documentation.
3. Move the jumper (J1E4) from the default operating position, covering pins 1 and 2, to the password clear position, covering **pins 2 and 3**.

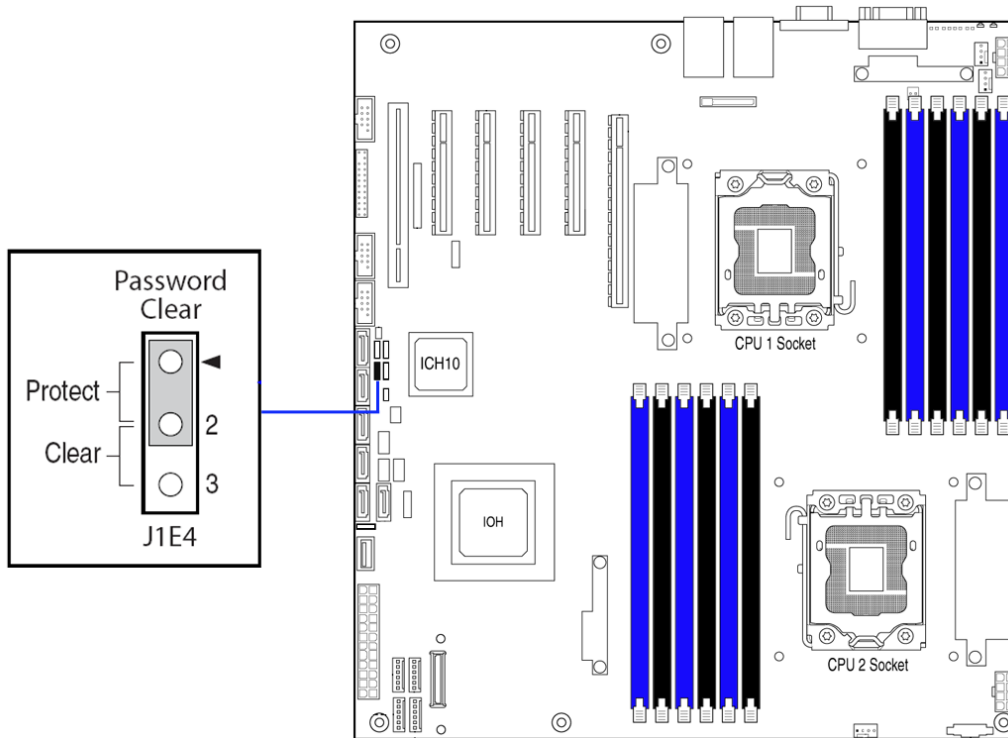

Figure 10. Password Clear Jumper

4. Close the server chassis.
5. Power up the server and then press <F2> to enter the BIOS menu to check if the password is cleared.
6. Power down the server.
7. Open the chassis and move the jumper back to its default position, covering pins 1 and 2.
8. Close the server chassis.
9. Power up the server.

The password is now cleared and you can reset it by going into the BIOS setup.

Clearing the CMOS

If you cannot access the BIOS setup screens, you must use the CMOS Clear jumper to reset the configuration RAM. The CMOS Clear jumper is located on jumper block **J1E6**.

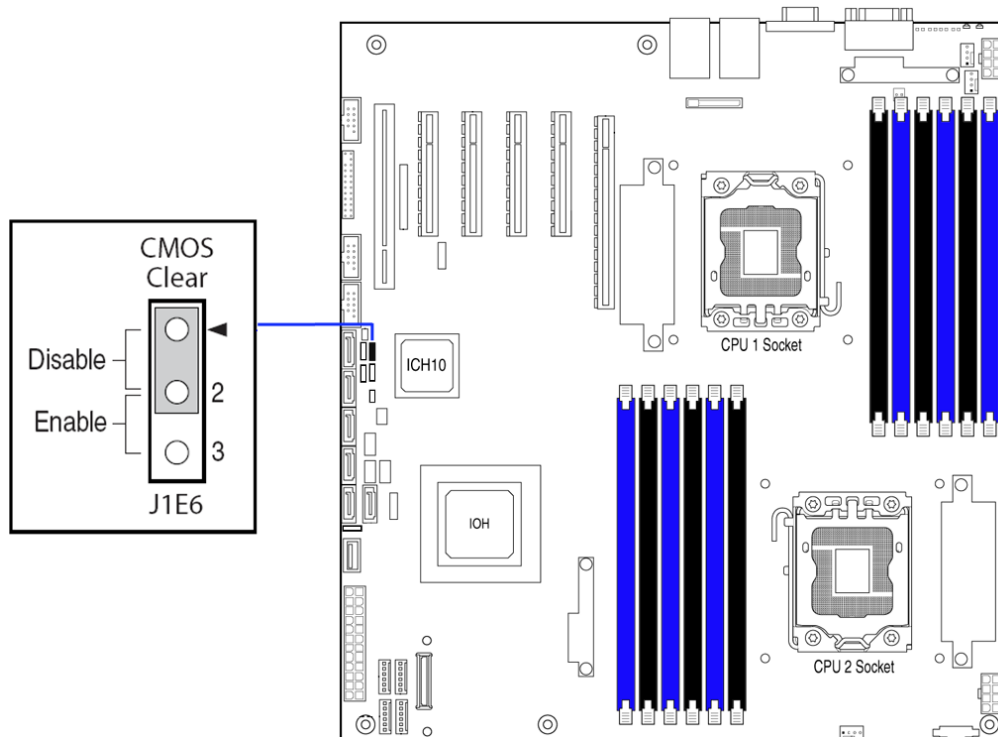

Figure 11. CMOS Clear Jumper

1. Power down the server and unplug the AC power cord.
2. Open the server chassis. For instructions, see your server chassis documentation.
3. Move the jumper (J1E6) from the default operating position (**covering pins 1 and 2**) to the reset/clear position (covering pins 2 and 3).
4. Wait 5 - 10 seconds.
5. Move the jumper back to default position, covering pins 1 and 2.
6. Close the server chassis and reconnect the AC power cord.
7. Power up the server.

The CMOS is now cleared and you can reset it by going into the BIOS setup.

3 Hardware Installations and Upgrades

Before You Begin

Before working with your server product, pay close attention to [“Safety Information”](#).

Tools and Supplies Needed

- Phillips* (cross head) screwdriver (#1 bit and #2 bit)
- Needle nosed pliers
- Antistatic wrist strap and conductive foam pad (recommended)

Installing and Removing Memory

The silkscreen on the board for the DDR3 DIMM sockets displays DIMM_A1, DIMM_A2, DIMM_B1, DIMM_B2, DIMM_C1, DIMM_C2, DIMM_D1, DIMM_D2, DIMM_E1, DIMM_E2, DIMM_F1, and DIMM_F2, starting from the inside of the board. See [“Memory”](#) for a discussion on memory installation rules, requirements, and options. See [“Additional Information and Software”](#).

Installing DIMMs

To install DIMMs, follow these steps:

1. Observe the safety and ESD precautions at the beginning of this book. For more information, see [“Safety Information”](#).
2. Turn off all peripheral devices connected to the server and turn off the server.
3. Disconnect the AC power cord from the server.
4. Remove the server’s cover and locate the DIMM sockets. See [“Memory”](#).

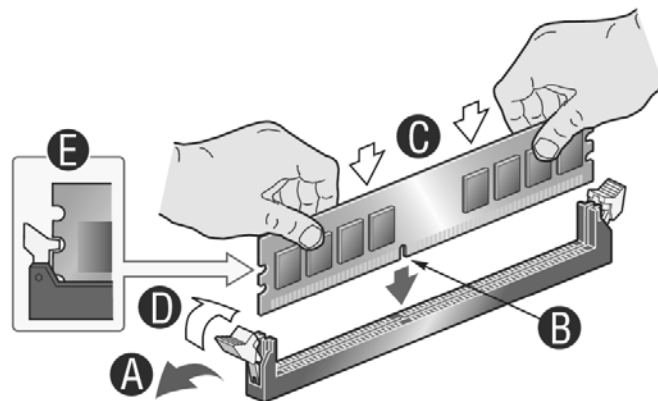

Figure 12 .Installing Memory

5. Make sure the clips at either end of the DIMM socket(s) are pushed outward to the open position (Step “A” in Figure 12).
6. Holding the DIMM by the edges, remove it from its anti-static package.
7. Position the DIMM above the socket. Align the small notch in the bottom edge of the DIMM with the key in the socket (Step “B” in Figure 12).
8. Insert the bottom edge of the DIMM into the socket (Step “C” in Figure 12).
9. When the DIMM is inserted, push down on the top edge of the DIMM until the retaining clips snap into place (Step “D” in Figure 12).
10. Visually check that each latch is fully closed and correctly engaged with each DIMM edge slot (Step “E” in Figure 12).
11. Replace the server’s cover and reconnect the AC power cord.

Removing DIMMs

To remove a DIMM, follow these steps:

1. Observe the safety and ESD precautions at the beginning of this book. For more information, see [“Safety Information”](#).
2. Turn off all peripheral devices connected to the server, and turn off the server.
3. Remove the AC power cord from the server.
4. Remove the server’s cover.
5. Gently spread the retaining clips at each end of the socket. The DIMM lifts from the socket.
6. Holding the DIMM by the edges, lift it from the socket, and store it in an anti-static package.
7. Reinstall and reconnect any parts you removed or disconnected to reach the DIMM sockets.
8. Replace the server’s cover and reconnect the AC power cord.

Installing or Replacing the Processor

/ NOTE

Use the following instructions to install or replace a processor instead of using the instructions that came with the processor.



CAUTION

Processor must be appropriate: If you install a processor that is inappropriate for your server, you may damage the server board. See [“Additional Information and Software”](#) for a link to the list of compatible processor(s).

ESD and handling processors: Reduce the risk of electrostatic discharge (ESD) damage to the processor by doing the following: (1) Touch the metal chassis before touching the processor or server board. Keep a part of your body in contact with the metal chassis to dissipate the static charge while handling the processor. (2) Avoid moving around unnecessarily.

Installing the Processor

To install a processor, follow these instructions:

NOTE

You must install processors in order. Therefore, you must populate CPU 1 socket to operate the board and to enable CPU 2 socket.



CAUTION

When opening a processor socket, **DO NOT** touch the gold socket wires.

When unpacking a processor, hold by the edges only to avoid touching the gold contact wires.

1. Observe the safety and ESD precautions at the beginning of this book. See [“Safety Information”](#) for more information.
2. Turn off all peripheral devices connected to the server and turn off the server.
3. Disconnect the AC power cord from the server.
4. Remove the server’s cover. See the document that came with your server chassis for instructions on removing the server’s cover.
5. Locate the processor socket, push the lever handle down and away from the socket to release it (Step “A” in Figure 13), and rotate the lever open all the way (Step “B” in Figure 13).

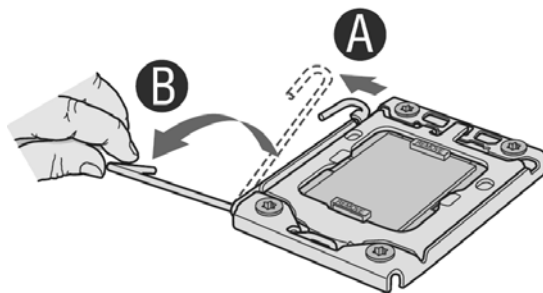

Figure 13. Opening the Processor Socket Lever

6. Open the load plate: push the rear tab with your fingertip to bring the front end of the load plate up slightly (Step “A” in Figure 14), and then open the load plate as shown in Figure 14 (Step “B”).

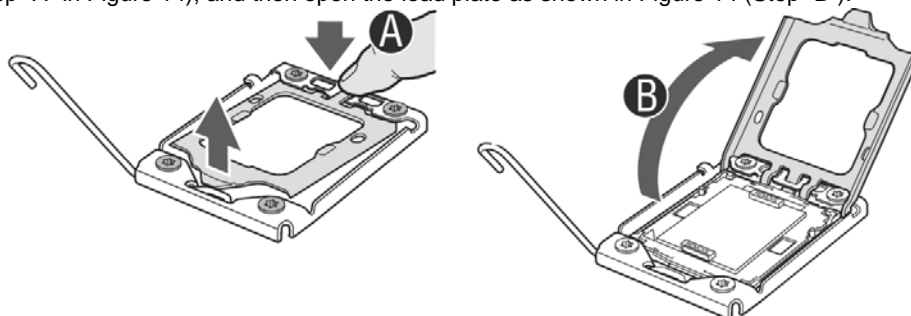

Figure 14. Opening the Processor Socket Load Plate

7. Remove the processor socket protective cover: Grasp the socket protective cover by the two tabs and carefully lift it straight up as shown in Figure 15.
8. Save the protective cover.

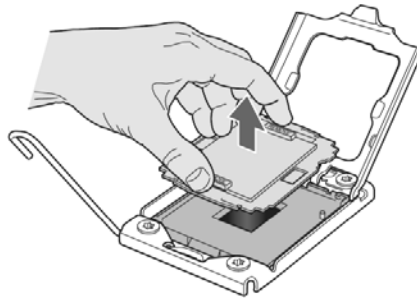

Figure 15. Removing the Processor Socket Protective Cover



CAUTION

To avoid damage, DO NOT drop the cover onto the socket wires or components.

9. Take the processor out of the box and remove the protective shipping cover as shown in Figure 16.



Figure 16. Remove Processor Protective Cover

10. Orient the processor with the socket so the processor cutouts match the two socket pins and then sit the processor into the socket as shown in Figure 17.

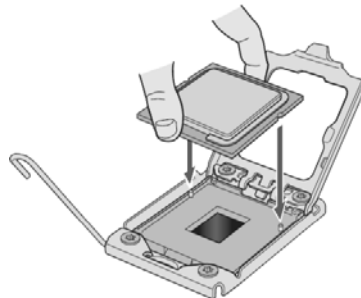

Figure 17. Install the processor

11. Close the load plate and socket lever: Close the load plate all the way as shown in Figure 18 (Step "A"), push down on the load plate (Step "B" in Figure 18), and close the socket lever and ensure the load plate tab engages under the socket lever when fully closed (Step "C" in Figure 18).

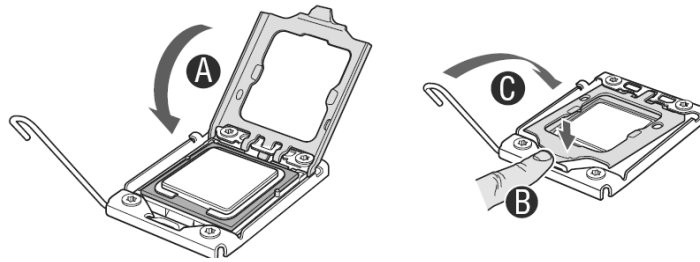

Figure 18. Close Load Plate and Socket Lever



12. Install the heatsink(s). See [“Installing the Processor Heatsink\(s\)”](#) for instructions.

Installing the Processor Heatsink(s)

Selecting Processor Heatsink(s)

Each processor requires a heatsink. Depending on your chassis, you may need to use either an active or a passive heatsink. An active heatsink has a fan attached to the heatsink and a cable that must be connected to the server board. The following table shows the Intel® Server Chassis compatible with this server board and whether each chassis requires an active or a passive heatsink. For a non-Intel chassis, see the documentation that came with your chassis.

Table 6. Heatsink Requirements for Compatible Intel® Server Chassis

Intel® Server Board S5520HC/S5520HCT/S5500HCV	Intel® Server Chassis	Heatsink Includes	Intel® Thermal Solution STS100C (w/ fan, active mode)	Intel® Thermal Solution STS100A (Active)	FXXRGTHSINK (Passive Tower Heatsink)
Y	SC5600Base	No	Y	Y	N
Y	SC5600BRP	No	Y	Y	N
Y	SC5600LX	No	N	N	Required
Y	SC5650DP	No	Y	Y	N
Y	SC5650BRP	No	Y	Y	N
Y: Support N: Not Support		Maximum CPU Power support in Intel® Server Chassis	95 W	80 W	95 W
		Boxed Product Code	BXSTS100C	BXSTS100A	FXXRGTHSINK
					

Installing Processor Heatsink(s)

To install processor heatsink(s) in the Intel® Server Chassis, follow these instructions:

1. Observe the safety and ESD precautions at the beginning of this book. For more information, see [“Safety Information”](#).
2. Turn off all peripheral devices connected to the server and turn off the server.
3. Disconnect the AC power cord from the server. Remove the server’s cover and locate the processor socket. See the document that came with your server chassis for instructions on removing the server’s cover.
4. If a protective film covers the thermal interface material (TIM) on the underside of the heatsink, remove the protective film. (Step “A” in Figure 19.)

Hardware Installations and Upgrades

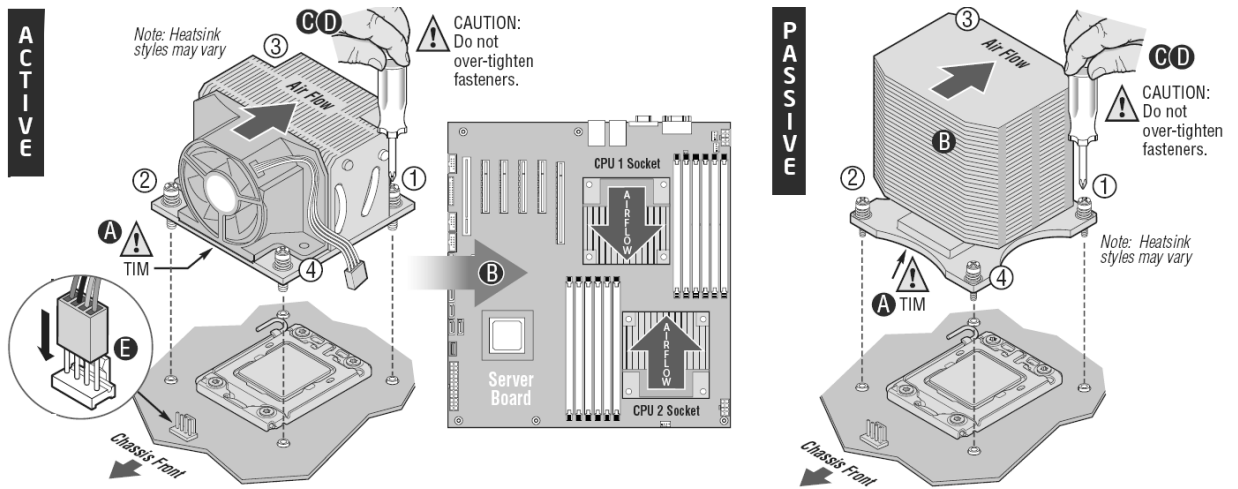
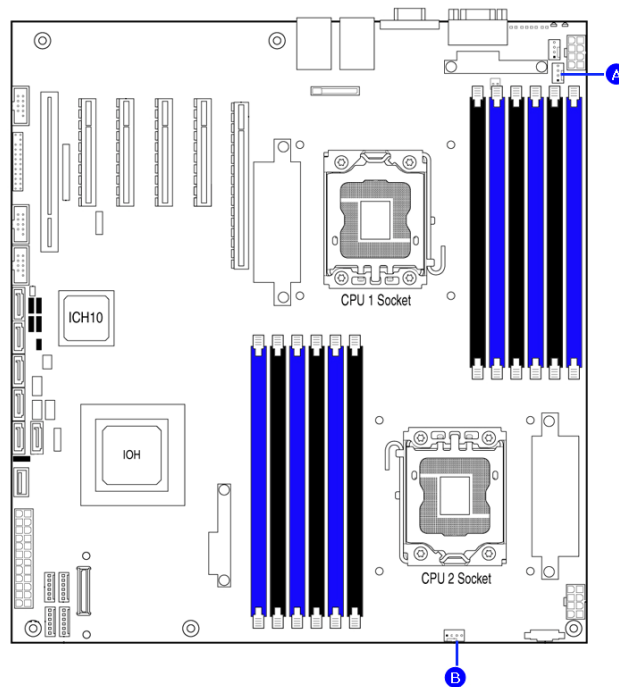

Figure 19. Installing Processor Heatsink(s)

- Align the active heatsinks in the Intel® Server Chassis SC5650 and Intel® Server Chassis SC5600 (excluding Intel® Server Chassis SC5600LX) to let airflow go through to the center of the board (Step “B” for active heatsink in Figure 19). Align the passive tower heatsinks (FXXRGTHSINK) fins to fit the Intel® Server Chassis SC5600LX air duct (Step “B” for passive heatsink in Figure 19).
- Using a #2 Philips* screwdriver to tighten each fastener diagonally according to the white-circled numbers in Figure 19. (Step “C” in Figure 19).
- Securely re-tighten each fastener again in the same order as performed in Step 6. (Step “D” in Figure 19.)



Callout	Processor Heatsink Connector	Callout	Processor Heatsink Connector
A.	CPU_1	B.	CPU_2

Figure 20. Locating Active Heatsink Cable Connections

8. Attach an active heatsink fan cable to the server board. (Step “E” in Figure 19). See Figure 20 to locate the processor fan headers.
9. Reinstall and reconnect any parts you removed or disconnected to reach the processor sockets. Refer to the documentation that came with your chassis for instructions on installing chassis components.
10. Replace the chassis cover and reconnect the AC power cord. Refer to the documentation that came with your chassis for instructions on installing the cover.

Replacing the Processor

1. Observe the safety and ESD precautions at the beginning of this book. For more information, see [“Safety Information”](#).
2. Turn off all peripheral devices connected to the server and turn off the server.
3. Disconnect the AC power cord from the server.
4. Remove the server’s cover and locate the processor socket. See the document that came with your server chassis for instructions on removing the server’s cover.
5. If needed, disconnect the active processor heatsink fan cable from the server board.
6. Loosen the four captive screws on the corner of the heatsink.
7. Twist the heatsink slightly to break the seal between the heatsink and the processor.
8. Lift the heatsink from the processor. If it does not pull up easily, twist the heatsink again. Do not force the heatsink from the processor – doing so could damage the processor.
9. Lift the processor socket lever.
10. Raise the processor socket load plate.
11. Remove the processor.
12. If installing a replacement processor, see [“Installing the Processor”](#).
13. Reinstall and reconnect any parts you removed or disconnected to reach the processor sockets. See the documentation that came with your chassis for instructions on installing chassis components.
14. Replace the chassis cover and reconnect the AC power cord. See the documentation that came with your chassis for instructions on installing the cover.

Replacing the CMOS Battery

The lithium CMOS battery on the server board powers the Real-Time Clock (RTC) in the absence of power. When the battery starts to weaken, it loses voltage, and the system settings stored in the CMOS RAM in the RTC (for example, the date and time) may be wrong. For a list of approved devices, contact your customer service representative or dealer.



WARNING

Danger of explosion if battery is incorrectly replaced. Replace only with the same or equivalent type recommended by the equipment manufacturer. Discard used batteries according to manufacturer’s instructions.



ADVARSEL!

Lithiumbatteri - Eksplosionsfare ved fejlagtig håndtering. Udskiftning må kun ske med batteri af samme fabrikat og type. Levér det brugte batteri tilbage til leverandøren.



ADVARSEL

Lithiumbatteri - Eksplosjonsfare. Ved utskifting benyttes kun batteri som anbefalt av apparatfabrikanten. Brukt batteri returneres apparatleverandøren.



VARNING

Explosionsfara vid felaktigt batteribyte. Använd samma batterityp eller en ekvivalent typ som rekommenderas av apparattillverkaren. Kassera använt batteri enligt fabrikantens instruktion.



VAROITUS

Paristo voi räjähtää, jos se on virheellisesti asennettu. Vaihda paristo ainoastaan laitevalmistajan suosittelemaan tyyppiin. Hävitä käytetty paristo valmistajan ohjeiden mukaisesti.

1. Observe the safety and ESD precautions at the beginning of this book. For more information, see [“Safety Information”](#).
2. Turn off all peripheral devices connected to the server and turn off the server.
3. Disconnect the AC power cord from the server.
4. Remove the chassis cover and locate the CMOS battery. Refer to the documentation that came with your chassis for instructions on removing the cover.
5. Use a finger to pull the lever away from the top of the battery until it clears the battery. Use caution so you do not bend the lever.
6. Lift the battery from the socket.

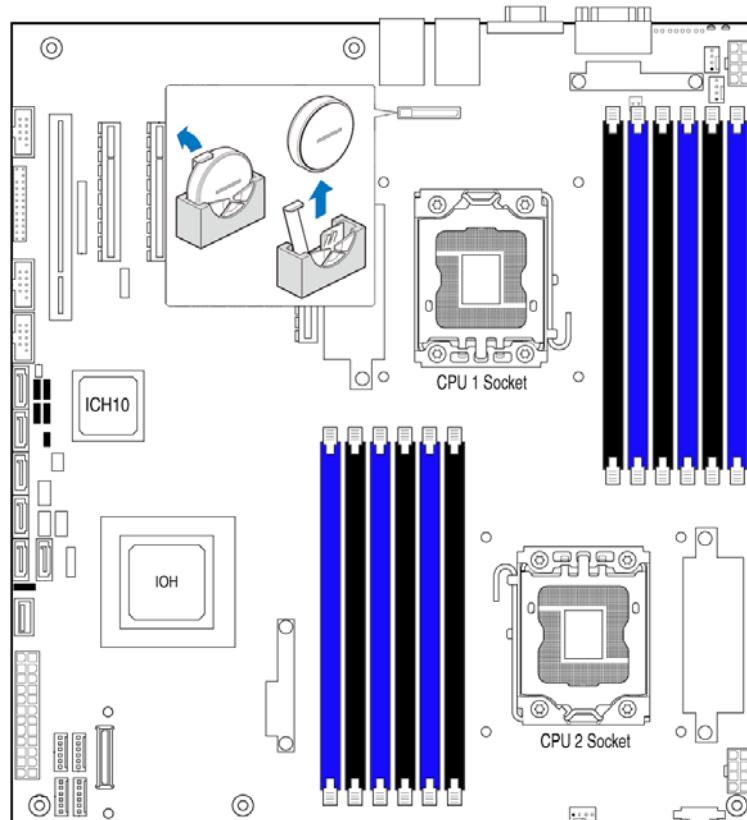

Figure 21. Locating and Removing the CMOS Battery

7. Dispose of the battery according to local ordinance.
8. Remove the new battery from its package.
9. Being careful to observe the correct polarity, insert the battery into the battery socket. The "+" side of the battery must face the lever side of the battery socket, towards the rear USB/NIC ports.
10. Reinstall and reconnect any parts you removed or disconnected to reach the processor sockets. See the documentation that came with your chassis for instructions on installing chassis components.
11. Replace the chassis cover and reconnect the AC power cord. See the documentation that came with your chassis for instructions on installing the cover.
12. Run the BIOS Setup utility to restore the configuration settings to the real-time clock (RTC).

4 Troubleshooting

This chapter helps you identify and solve problems that might occur while using the system.

For any issue, first ensure you are using the latest software. These software updates include updates for the BIOS, Baseboard Management Controller (BMC), FRUSDR, hot-swap controller (HSC), and the Management Engine (ME) firmware. For a link to the software updates, see [“Additional Information and Software”](#). In addition to the server firmware and files, you must also update any drivers used for components installed in your system, such as chipset drivers, video drivers, network drivers, and storage device drivers.

Intel provides a package called the “Platform Confidence Test” that may help with your diagnostics. See [“Additional Information and Software”](#) for a link to this software.

If you cannot resolve your server problems on your own, see [“Getting Help”](#) for assistance.

Resetting the System

Before going through in-depth troubleshooting, attempt first to perform a reset of your system using one of the following methods.

Table 7. POST Error Beep Codes

To do this:	Press:
Soft boot reset to clear the system memory and reload the operating system.	<Ctrl+Alt+Del>
Clear system memory, restart POST, and reload the operating system.	Reset button
Cold boot reset. Turn the system power off and then on. This halts power to all peripherals, clears system memory, restarts POST, and reloads the operating system.	Power off/on

Problems following Initial System Installation

Problems that occur at initial system startup are usually caused by an incorrect installation or configuration. Hardware failure is a less frequent cause. If the problem you are experiencing is with a specific software application, see [“Problems with Newly Installed Application Software”](#).

First Steps Checklist

1. Is AC power available at the wall outlet?
2. Are the power supplies plugged in? Check the AC cable(s) on the back of the chassis and at the AC source.
3. Are all cables correctly connected and secured?
4. Are the processors fully seated in their sockets on the server board?
5. Are all standoffs in the proper location and not touching any components, causing a potential short?
6. Are all add-in PCI boards fully seated in their slots on the server board?
7. Are all jumper settings on the server board correct?
8. Are all jumper and switch settings on add-in boards and peripheral devices correct? To check these settings, refer to the manufacturer’s documentation that comes with them. If applicable, ensure there are no conflicts—for example, two add-in boards sharing the same interrupt.
9. Are all peripheral devices installed correctly?
10. If the system has a hard disk drive, is it properly formatted or configured?
11. Are all device drivers properly installed?
12. Are the configuration settings made in the Setup correct?
13. Is the operating system properly loaded? See the operating system documentation.

14. Did you press the system power on/off switch on the front panel to turn the server on (power on light should be lit)?
15. Is the system power cord properly connected to the system and plugged into a NEMA 5-15R outlet for ~100-120 V or a NEMA 6-15R outlet for ~200-240 V?
16. Are all integrated components from the tested components lists? Check the tested memory and chassis lists, and the supported hardware and operating system list. For links to the tested component lists, see [“Additional Information and Software”](#).

Hardware Diagnostic Testing

This section provides a more detailed approach to identifying a hardware problem and locating its source.



CAUTION

Turn off devices before disconnecting cables: Before disconnecting any peripheral cables from the system, turn off the system and any external peripheral devices. Failure to do so can cause permanent damage to the system and/or the peripheral devices.

1. Turn off the system and all external peripheral devices. Disconnect each device from the system except for the keyboard and the video monitor.
2. Make sure the system power cord is plugged into a properly grounded AC outlet.
3. Make sure your video display monitor and keyboard are correctly connected to the system. Turn on the video monitor. Set its brightness and contrast controls to at least two-thirds of their maximum ranges (see the documentation supplied with your video display monitor).
4. If the operating system normally loads from the hard disk drive, make sure there is no diskette in drive A and no CD-ROM disk in the CD-ROM drive.
5. If the power LED does light, attempt to boot from a floppy diskette or from a CD-ROM disk.
6. Turn on the system. If the power LED does not light, see [“Power Light Does Not Light”](#).

Verifying Proper Operation of Key System Lights

As POST determines the system configuration, it tests for the presence of each mass storage device installed in the system. As each device is checked, its activity light should turn on briefly. Check for the following:

1. Does the drive activity light turn on briefly? If not, see [“CD-ROM Drive or DVD-ROM Drive Activity Light Does Not Light”](#).
2. If system LEDs are illuminated, see [“Intel® Light-Guided Diagnostics”](#) for a description of the lights.

Confirming Loading of the Operating System

Once the system boots up, the operating system prompt displays on the screen. The prompt varies according to the operating system. If the operating system prompt does not display, see [“No Characters Appear on Screen”](#).

Specific Problems and Corrective Actions

This section provides possible solutions for these specific problems:

- Power light does not light.
- No characters display on screen.

Troubleshooting

- Characters on the screen appear distorted or incorrect.
- System cooling fans do not rotate.
- CD-ROM or DVD-ROM drive activity light does not light.
- There are problems with application software.
- The bootable CD-ROM or DVD-ROM is not detected.

Try the following solutions in the order given. If you cannot correct the problem, contact your service representative or authorized dealer for help.

Power Light Does Not Light

Check the following:

1. Did you press the power-on button?
2. Is the system operating normally? If so, the power LED might be defective or the cable from the front panel to the server board might be loose.
3. Have you securely plugged the server AC power cord into the power supply?
4. Is the power supply correctly set to 110 V or 235 V, depending on your power output?
5. Will other items plugged into the same power outlet function correctly?
6. Remove all add-in cards and see if the system boots. If successful, add the cards back in one at a time with a reboot between each addition to determine which card might be causing the problem.
7. Make sure the DDR3 memory DIMMs comply with the system requirements.
8. Make sure the DDR3 memory DIMMs were populated according to the system requirements.
9. Remove the DDR3 memory DIMMs and re-seat them.
10. Make sure the processor(s) comply with the system requirements.
11. Make sure the processor(s) were populated according to the system requirements.
12. Remove the processor(s) and re-seat them.
13. Make sure the chassis standoffs are installed only below mounting holes. Misplaced standoffs can contact the pins on the bottom of the server board and cause a short.
14. In a DC-powered system, make sure all DC cables are connected.

No Characters Appear on Screen

Check the following:

1. Is the keyboard functioning? Test it by turning the "Num Lock" function on and off to make sure the Num Lock light is functioning.
2. Is the video monitor plugged in and turned on? If you use a switch box, is it switched to the correct system?
3. Are the brightness and contrast controls on the video monitor properly adjusted?
4. Is the video monitor signal cable properly installed?
5. Does this video monitor work correctly if plugged into a different system?
6. Is the on-board video controller enabled in the BIOS?
7. Remove all add-in cards and see if the video returns. If successful, add the cards back in one at a time with a reboot between each addition.
8. Make sure the DDR3 memory DIMMs comply with the system requirements.
9. Make sure the DDR3 memory DIMMs were populated according to the system requirements.

10. Remove the DDR3 memory DIMMs and re-seat them.
11. Make sure the processor(s) comply with the system requirements.
12. Make sure the processor(s) were populated according to the system requirements.
13. Remove the processor(s) and re-seat them.

If you use an add-in video controller board, do the following:

1. Verify the video works using the on-board video controller.
2. Verify the video controller board is fully seated in the server board connector.
3. Reboot the system for changes to take effect.
4. If there are still no characters on the screen after you reboot the system and POST emits a beep code, write down the beep code you hear. This information is useful for your service representative.
5. If you do not receive a beep code and characters do not display, the video display monitor or video controller may have failed. Contact your service representative or authorized dealer for help.

Characters Are Distorted or Incorrect

Check the following:

1. Are the brightness and contrast controls properly adjusted on the video monitor? See the manufacturer's documentation.
2. Are the video monitor's signal and power cables properly installed?
3. Does this video monitor work correctly if plugged into a different system?

System Cooling Fans Do Not Rotate Properly

If the system cooling fans are not operating properly, it is an indication of possible system component failure.

Check the following:

1. Is the power-on light lit? If not, see ["Power Light Does Not Light"](#).
2. If your system has LED lights for the fans, is one or more of these LEDs lit?
3. Are any other front panel LEDs lit?
4. Have any of the fan motors stopped? Use the server management subsystem to check the fan status.
5. Have your fans speeded up in response to an overheating situation?
6. Have your fans speeded up in response to a fan that failed?
7. Are the fan power connectors properly connected to the server board?
8. Is the cable from the front panel board connected to the both the front panel board and to the server board?
9. Are the power supply cables properly connected to the server board?
10. Are there any shorted wires caused by pinched-cables or have power connector plugs been forced into power connector sockets the wrong way?

CD-ROM Drive or DVD-ROM Drive Activity Light Does Not Light

Check the following:

1. Are the CD-ROM/DVD-ROM drive's power and signal cables properly installed?
2. Is the drive properly configured?

Cannot Connect to a Server

1. Make sure the network cable is securely attached to the correct connector at the system back panel.
2. Try a different network cable.
3. Make sure you are using the correct and the current drivers. For a link to the current drivers, see ["Additional Information and Software"](#).
4. Make sure the driver is loaded and the protocols are bound.
5. Make sure the hub port is configured for the same duplex mode as the network controller.
6. Make sure the correct networking software is installed.
7. If you are directly connecting two servers (without a hub), you will need a crossover cable.
8. Check the network controller LEDs next to the NIC connectors.

Problems with Network

The server hangs when the drivers are loaded

- Certain drivers may require interrupts that are not shared with other PCI drivers. For these drivers, it may be necessary to alter settings so interrupts are not shared. See the documentation that came with your PCI card(s) for information on changing interrupts.

Diagnostics pass but the connection fails

- Make sure the network cable is securely attached.
- Make sure you specify the correct frame type in your NET.CFG file.

The controller stopped working when an add-in adapter was installed

- Make sure the cable is connected to the port from the on-board network controller.
- Make sure your BIOS is current. For a link to the current version, see ["Additional Information and Software"](#).
- Make sure the other adapter supports shared interrupts. Make sure your operating system supports shared interrupts.
- Try reseating the add-in adapter.

The add-in adapter stopped working without apparent cause

- Try reseating the adapter first; then try a different slot if necessary.
- The network driver files may be corrupt or deleted. Delete and then reinstall the drivers.
- Run the diagnostics.

System Boots when Installing PCI Card

System Server Management features require full-time “standby” power. This means some parts of the system have power going to them whenever the power cord is plugged in, even if you turned-off the system power with the power button on the front panel. If you install a PCI card with the AC power cord plugged in, a signal may be sent to command the system to boot. Before installing a PCI card, you should always:

- Turn off the server power by using the power button on the front of the system.
- Unplug the AC power cord(s) from the server.

Problems with Newly Installed Application Software

Problems that occur when you run new application software are usually related to the software—not the server hardware. Faulty equipment is unlikely, especially if other software runs correctly.

Check the following:

1. Make sure the system meets the minimum hardware requirements for the software. See the software documentation.
2. Make sure the software is properly installed and configured for the system. See the software documentation.
3. Use only an authorized copy. Unauthorized copies often do not work.
4. If you run the software from a diskette, CD-ROM, or DVD-ROM, try a different diskette.
5. Make sure the correct device drivers are installed.

If the problems persist, contact the software vendor’s customer service representative.

Problems with Application Software that Ran Correctly Earlier

Problems that occur after the system hardware and software have been running correctly sometimes indicate equipment failure. However, they can also be caused by file corruption or changes to the software configuration.

Check the following:

1. If you are running the software from a USB floppy disk, CD-ROM, or DVD-ROM, try a different disk.
2. Check your system with a virus infection.
3. Uninstall and reinstall the software. Make sure all necessary files are installed.
4. If the problems are intermittent, there may be a loose cable, dirt in the keyboard (if keyboard input is incorrect), a marginal power supply, or other random component failures.
5. If you suspect a transient voltage spike, power outage, or brownout might have occurred, reload the software and try running it again. Symptoms of voltage spikes include a flickering video display, unexpected system reboots, and the system not responding to user commands.

NOTE

Random errors in data files: *If you are getting random errors in your data files, they may be getting corrupted by voltage spikes on your power line. If you experience any of the above symptoms that might indicate voltage spikes on the power line, you may want to install a surge suppressor between the power outlet and the system power cord.*

Devices are not Recognized under Device Manager (Microsoft Windows* Operating System)

The Microsoft Windows* operating systems do not include all of the drivers for the Intel® chipsets, on-board NICs, and other components. See [“Additional Information and Software”](#) for a link to the current drivers and chipset files.

Hard Drive(s) are not Recognized

Check the following:

1. Make sure the drive is not disabled in the BIOS Setup.
2. Make sure the drive is connected correctly and plugged into the power supply.
3. Make sure the drive is compatible. See [“Additional Information and Software”](#) for a link to the tested drives.
4. Make sure you have not exceeded the power budget for the server. See [“Additional Information and Software”](#) for a link to software to check your power budget.
5. Verify your SAS or SATA drives are connected to the correct ports on the server board and the chassis backplane. See your chassis documentation for details about backplane connections.
6. If using a RAID configuration with SAS or SATA drives, make sure the RAID card is installed correctly.

Bootable CD-ROM/DVD-ROM Disk Is Not Detected

Check the following:

- Make sure the BIOS is configured to allow the CD-ROM to be the first bootable device.

LED Information

The Intel® Server Board S5520HC/S5520HCT/S5500HCV includes LEDs that can aid in troubleshooting your system. See [“Intel® Light-Guided Diagnostics”](#).

BIOS POST Beep Codes

The following table lists the POST error beep codes. Prior to system video initialization, the BIOS uses these beep codes to inform users of error conditions. Please note that not all error conditions are supported by the BIOS beep codes.

Table 8. BIOS POST Error Beep Codes

Number of Beeps	Reason for the Beeps and Action to Take
3	<p>Memory error.</p> <ul style="list-style-type: none">▪ Make sure the DDR3 memory DIMMs comply with the system requirements.▪ Make sure the DDR3 memory DIMMs were populated according to the system requirements.▪ Remove the DDR3 memory DIMMs and re-seat them.▪ Replace the DDR3 Memory DIMMs with known good modules.

The Intel® Server Board S5520HC/S5520HCT/S5500HCV integrated Baseboard Management Controller (BMC) provides the following additional beep codes:

Table 9. BMC POST Error Beep Codes

Number of Beeps	Reason for the Beeps and Action to Take
1-5-2-1	No CPUs installed or first CPU socket is empty.
1-5-4-2	Power fault: DC power unexpectedly lost (power good dropout).
1-5-4-4	Power control fault (power good assertion timeout).

Appendix A: Regulatory and Compliance Information

Product Regulatory Compliance

Product Safety Compliance

The Intel® Server Board S5520HC/S5520HCT/S5500HCV comply with the following safety requirements:

- UL60950 – CSA 60950(USA/Canada)
- EN60950 (Europe)
- IEC60950 (International)
- CB Certificate & Report, IEC60950 (report to include all country national deviations)
- CE - Low Voltage Directive 73/23/EEE (Europe)

Product EMC Compliance – Class A Compliance

The Intel® Server Board S5520HC/S5520HCT/S5500HCV have been tested and verified to comply with the following electromagnetic compatibility (EMC) regulations when installed a compatible Intel® host system. For information on compatible host system(s) refer to

<http://support.intel.com/support/motherboards/server/S5520HC/> or contact your local Intel representative.

- FCC /ICES-003 - Emissions (USA/Canada) Verification
- CISPR 22 – Emissions (International)
- EN55022 - Emissions (Europe)
- EN55024 - Immunity (Europe)
- CE – EMC Directive 89/336/EEC (Europe)
- AS/NZS 3548 Emissions (Australia/New Zealand)
- VCCI Emissions (Japan)
- BSMI CNS13438 Emissions (Taiwan)
- RRL Notice No. 1997-41 (EMC) & 1997-42 (EMI) (Korea)







Certifications/Registrations/Declarations

- UL Certification (US/Canada)
- CE Declaration of Conformity (CENELEC Europe)
- FCC/ICES-003 Class A Attestation (USA/Canada)
- C-Tick Declaration of Conformity (Australia)
- MED Declaration of Conformity (New Zealand)
- BSMI Certification (Taiwan)
- RRL Certification (Korea)
- Ecology Declaration (International)

Product Regulatory Compliance Markings

This product is marked with the following Product Certification Markings:

Table 10. Product Certification Markings

Regulatory Compliance	Country	Marking
UL Mark	USA/Canada	
CE Mark	Europe	
EMC Marking (Class A)	Canada	CANADA ICES-003 CLASS A CANADA NMB-003 CLASSE A
BSMI Marking (Class A)	Taiwan	
		警告使用者： 這是甲類的資訊產品，在居住的環境中使用時， 可能會造成射頻干擾，在這種情況下，使用者會 被要求採取某些適當的對策
C-tick Marking	Australia/New Zealand	
RRL KCC Mark	Korea	 방송통신위원회
EFUP Mark	China	
Country of Origin	Exporting Requirements	Made in xxxxx
Model Designation	Regulatory Identification	Examples (Server Board S5520HC) for boxed type boards; or Board PB number for non-boxed boards (typically high-end boards)

Electromagnetic Compatibility Notices

FCC (USA)

This device complies with Part 15 of the FCC Rules. Operation is subject to the following two conditions: (1) this device may not cause harmful interference, and (2) this device must accept any interference received, including interference that may cause undesired operation.

Regulatory and Compliance Information

For questions related to the EMC performance of this product, contact:

Intel Corporation
5200 N.E. Elam Young Parkway
Hillsboro, OR 97124-6497
1-800-628-8686

This equipment has been tested and found to comply with the limits for a Class A digital device, pursuant to Part 15 of the FCC Rules. These limits are designed to provide reasonable protection against harmful interference in a residential installation. This equipment generates, uses, and can radiate radio frequency energy and, if not installed and used in accordance with the instructions, may cause harmful interference to radio communications. However, there is no guarantee that interference will not occur in a particular installation. If this equipment does cause harmful interference to radio or television reception, which can be determined by turning the equipment off and on, the user is encouraged to try to correct the interference by one or more of the following measures:

- Reorient or relocate the receiving antenna.
- Increase the separation between the equipment and the receiver.
- Connect the equipment to an outlet on a circuit other than the one to which the receiver is connected.
- Consult the dealer or an experienced radio/TV technician for help.

Any changes or modifications not expressly approved by the grantee of this device could void the user's authority to operate the equipment. The customer is responsible for ensuring compliance of the modified product.

Only peripherals (computer input/output devices, terminals, printers, etc.) that comply with FCC Class A or B limits may be attached to this computer product. Operation with noncompliant peripherals is likely to result in interference to radio and TV reception.

All cables used to connect to peripherals must be shielded and grounded. Operation with cables, connected to peripherals, that are not shielded and grounded may result in interference to radio and TV reception.

ICES-003 (Canada)

Cet appareil numérique respecte les limites bruits radioélectriques applicables aux appareils numériques de Classe A prescrites dans l'anorme sur le matériel brouilleur: "Appareils Numériques", NMB-003 édictée par le Ministre Canadian des Communications.

This digital apparatus does not exceed the Class A limits for radio noise emissions from digital apparatus set out in the interference-causing equipment standard entitled: "Digital Apparatus," ICES-003 of the Canadian Department of Communications.

Europe (CE Declaration of Conformity)

This product has been tested in accordance too, and complies with the Low Voltage Directive (73/23/EEC) and EMC Directive (89/336/EEC). The product has been marked with the CE Mark to illustrate its compliance.

VCCI (Japan)

この装置は、情報処理装置等電波障害自主規制協議会（VCCI）の基準に基づくクラスB情報技術装置です。この装置は、家庭環境で使用することを目的としていますが、この装置がラジオやテレビジョン受信機に近接して使用されると、受信障害を引き起こすことがあります。

取扱説明書に従って正しい取り扱いをして下さい。

English translation of the notice above:

This is a Class B product based on the standard of the Voluntary Control Council for Interference (VCCI) from Information Technology Equipment. If this is used near a radio or television receiver in a domestic environment, it may cause radio interference. Install and use the equipment according to the instruction manual.

BSMI (Taiwan)

The BSMI Certification Marking and EMC warning is located on the outside rear area of the product.

警告使用者：
這是甲類的資訊產品，在居住的環境中使用時，可能會造成射頻干擾，在這種情況下，使用者會被要求採取某些適當的對策

RRL (Korea)



방송통신위원회

Product Ecology Change (EU RoHS)

Intel has a system in place to restrict the use of banned substances in accordance with the European Directive 2002/95/EC. Compliance is based on declaration that materials banned in the RoHS Directive are either (1) below all applicable threshold limits or (2) an approved/pending RoHS exemption applies.

RoHS implementation details are not fully defined and may change.

Threshold limits and banned substances are noted below:

- Quantity limit of 0.1% by mass (1000PPM) for:
 - Lead
 - Mercury
 - Hexavalent Chromium
 - Polybrominated Biphenyls Diphenyl Ethers (PBDE)
- Quantity limit of 0.01% by mass (100 PPM) for:
 - Cadmium

Product Ecology Change (CRoHS)

CRoHS (China RoHS, or Ministry of Information Industry Order #39, “Management Methods for Controlling Pollution by Electronic Information Products.”):

- China bans the same substances and limits as noted for EU RoHS; however require product marking and controlled substance information Environmental Friendly

Regulatory and Compliance Information

Usage Period (EFUP) Marking is defined in number of years in which controlled listed substances will not leak or chemically deteriorate while in the product. Intel understands the end-seller (entity placing product into market place) is responsible for providing EFUP marking.

- Intel “retail” products are provided with EFUP marking
- For “Business to Business” products, Intel intends to place EFUP marking on product for customer convenience
- EFUP for Intel server products has been determined as 20 years.

Below is an example of EFUP mark applied to Intel server products.



CRoHS Substance Tables:

China CRoHS requires products to be provided with controlled substance information. Intel understands the end-seller (entity placing product into market place) is responsible for providing the controlled substance information. Controlled substance information is required to be in Simplified Chinese. Substance table for this board product is as follows:

关于符合中国《电子信息产品污染控制管理办法》的声明

Management Methods on Control of Pollution from
Electronic Information Products
(China RoHS declaration)

产品中有毒有害物质的名称及含量

部件名称 (Parts)	有毒有害物质或元素					
	铅 (Pb)	汞 (Hg)	镉 (Cd)	六价铬 (Cr6+)	多溴联苯 (PBB)	多溴二苯醚 (PBDE)
金属部件 Metal Parts	○	○	○	x	○	○
印刷板组件 Printed Board Assemblies (PBA)	x	○	○	○	○	○

○：表示该有毒有害物质在该部件所有均质材料中的含量均在 SJ/T 11363-2006 标准规定的限量要求以下。
○：Indicates that this hazardous substance contained in all homogeneous materials of this part is below the limit requirement in SJ/T 11363-2006.
x：表示该有毒有害物质至少在该部件的某一均质材料中的含量超出 SJ/T 11363-2006 标准规定的限量要求。
x：Indicates that this hazardous substance contained in at least one of the homogeneous materials of this part is above the limit requirement in SJ/T 11363-2006.

对销售之日的所售产品,本表显示我公司供应链的电子信息产品可能包含这些物质。注意：在所售产品中可能会也可能不会含有所有所列的部件

This table shows where these substances may be found in the supply chain of our electronic information products, as of the date of sale of the enclosed product. Note that some of the component types listed above may or may not be a part of the enclosed product.

China Packaging Recycle Marks (or GB18455-2001)

Intel EPSD has the following ecological compliances:

Cardboard and fiberboard packaging will be marked as recyclable in China.

China Packaging Recycling Marks is required on retail packaging to be marked as recyclable using China's recycling logo. Due to regional variances in mark acceptances, all three marks accepted worldwide will be implemented on Intel's cardboard and fiberboard. Examples of marks are shown below.



CA Perchlorate Warning

CA Lithium Perchlorate Warning (California Code of Regulations, Title 22, Division 4.5, Chapter 33: Best Management Practices for Perchlorate Materials):

The State of California requires a warning to be included for products containing a device using Lithium Perchlorate.

Intel understands CA Lithium Perchlorate require a printed warning to be included with all products containing a Lithium battery, either as an insert, in existing product literature, or as part of the shipping memo wording.

Wording is as follows:

Perchlorate Material - special handling may apply. See www.dtsc.ca.gov/hazardouswaste/perchlorate.

This notice is required by California Code of Regulations, Title 22, Division 4.5, Chapter 33: Best Management Practices for Perchlorate Materials. This product/part includes a battery that contains Perchlorate material.

End-of-Life/Product Recycling

Product recycling and end-of-life take-back systems and requirements vary by country.

Contact the retailer or distributor of this product for information about product recycling and/or take-back.

Appendix B: Getting Help

World Wide Web

<http://support.intel.com/support/motherboards/server/S5520HC/>

If you encounter an issue with your server platform, please follow these steps to obtain support on your product.

1. Get connected to our [support web page](#) for 24x7 support when you need it to get the latest and most complete technical support information on all Intel Enterprise Server and Storage Platforms. Information available at the support site includes:
 - o Latest BIOS, firmware, drivers, and utilities
 - o Product documentation, installation and quick start guides
 - o Full product specifications, technical advisories and errata
 - o Compatibility documentation for memory, hardware add-in cards, chassis support matrix, and operating systems
 - o Server and chassis accessory parts list for ordering upgrades or spare parts
 - o A searchable knowledgebase to search for product information throughout the support site
2. Send an email to Intel's technical support center using the following online form if you still cannot obtain a solution to your issue.
3. Lastly, you can contact an Intel support representative using one of the following support phone numbers. Charges may apply. Intel customer support suggests filling out the [issue report form](#) to better service the issue.

Intel now offers Channel Program members around-the-clock [24x7 technical phone support+](#) on Intel® server boards, server chassis, server RAID controller cards, and Intel® Server Management.

Warranty Information

Connect to Intel's website to obtain warranty information.

+ Requires login to the reseller site to obtain the 24x7 Number.

Intel® Server Issue Report Form

Issue Report Form (Rev 3.5)

NOTE: Filling out this form completely is required for any escalation.

Customer Contact Information:

Customer Support Case#:

Intel® Server Board or System:

(Example: S5520HC, S5520SC)

Server Chassis:

(Example SC5600. If third-party chassis used, indicate make and model.)

Base Board Information: (You can find some information by accessing the BIOS and going through the Server Management menu -> System Information.)

Baseboard PBA/TA/AA # (Example: 123456-789):

- You can find this on the white sticker label on the baseboard.

System BIOS Version:

Intel® Remote Management Module Firmware Version (if applicable):

Intel® Management Module BMC Revision (if applicable):

BMC/mBMC Version:

FRU/SDR Version:

HSC Version:

Has the latest BIOS been tried? (Yes/No):

Has the latest BMC/mBMC been tried? (Yes/No):

Has the latest IMM BMC been tried? (Yes/No):

Has the latest RMM Firmware been tried? (Yes/No):

Has the latest FRU/SDR been tried? (Yes/No):

Has the latest HSC been tried? (Yes/No):

Processor information:

	Type	Speed	sSpec	Thermal Solution
Processor 1				
Processor 2				
Processor 3				
Processor 4				

Thermal solution (Heatsink) examples:

(1U, Passive with air ducting, Active w/fan, and so on)

Memory:

Manufacturer	Part Number	DRAM Part Number	On Intel tested list?

Add-in adapters (Example: NICs, Management Adapters, Serial Expansion Cards, PCI Express* Adapters, RAID Controllers, SCSI Controllers, and so on):

Type	Slot	Manufacturer	Model	Firmware

Other third part hardware (Example: Example: KVM, Chassis, and so on):

Description/Use	Manufacturer	Model	Firmware

Storage Devices (Example: SCSI, SATA, SAS, USB, Tape, and so on):

Manufacturer	Model	Type	Size	Firmware	In Hot Swap Bay?

Operating System Information (Example: Red Hat* Enterprise Linux, Microsoft Windows* Server 2003, Service pack 1, OEM CD):

Manufacturer:

Version:

Language version (English, Arabic, Chinese (Simplified)):

Service Pack Level or Kernel Revision:

Distribution (OEM/Retail):

Intel® RAID Controller: (Example SRCU42E)

RAID controller part number (PBA number):

RAID controller firmware version:

Has the latest RAID firmware been tried? (Yes/No):

RAID driver version:

Has the latest RAID driver been tried? (Yes/No):

RAID volumes configuration (disks and RAID level):

RAID volume use (Boot device/Data Volume):

Is BBU (Battery Backup Unit) installed? (Yes/No):

BBU part number:

Detailed description of issue:

Troubleshooting tried:

Steps to replicate the issue:

Issue impact statements:

Do you have any potential Intel system, or component purchases that this issue is holding up? If yes, please provide a brief description below.

Do you have systems already purchased that are not being delivered to your customers because of this issue? If yes, please provide a brief description below.

Have you returned systems or components to your place of purchase because of this issue? If yes, please provide a brief description below.

*All other brands and names are property of their respective owners.