

Intel® Server Compute Blade SBXD132 Installation and User's Guide

**A Guide for Technically Qualified Assemblers of Intel® Identified Subassemblies/
Products**

Intel Order Number D64326-002

Disclaimer

Information in this document is provided in connection with Intel® products. No license, express or implied, by estoppel or otherwise, to any intellectual property rights is granted by this document. Except as provided in Intel's Terms and Conditions of Sale for such products, Intel assumes no liability whatsoever, and Intel disclaims any express or implied warranty, relating to sale and/or use of Intel® products including liability or warranties relating to fitness for a particular purpose, merchantability, or infringement of any patent, copyright or other intellectual property right. Intel products are not designed, intended or authorized for use in any medical, life saving, or life sustaining applications or for any other application in which the failure of the Intel product could create a situation where personal injury or death may occur. Intel may make changes to specifications and product descriptions at any time, without notice.

Intel® server boards contain a number of high-density VLSI and power delivery components that need adequate airflow for cooling. Intel's own chassis are designed and tested to meet the intended thermal requirements of these components when the fully integrated system is used together. It is the responsibility of the system integrator that chooses not to use Intel developed server building blocks to consult vendor datasheets and operating parameters to determine the amount of airflow required for their specific application and environmental conditions. Intel Corporation can not be held responsible if components fail or the server board does not operate correctly when used outside any of their published operating or non-operating limits.

Intel, Intel Pentium, and Intel Xeon are trademarks or registered trademarks of Intel Corporation or its subsidiaries in the United States and other countries.

* Other names and brands may be claimed as the property of others.

Copyright © 2006-2007, Intel Corporation. All Rights Reserved

Contents

Safety Information	vii
Important Safety Instructions	vii
Wichtige Sicherheitshinweise	vii
Consignes de sécurité	vii
Instrucciones de seguridad importantes	vii
Warnings.....	viii
Introduction	1
Related Documentation	2
The Resource CD	3
Hardware and Software Requirements	3
Notices and Statements Used in this Document	3
Features and Specifications	4
What Your Blade Server Offers	5
Reliability, Availability, and Serviceability Features	6
Major Components of the Blade Server.....	8
Power, Controls, Jumpers, Switches, and Indicators	9
Turning on the Blade Server	9
Turning off the Blade Server	9
Understanding the Control Panel and LEDs	10
Blade Server Connectors	12
Installing Options	15
Installation Guidelines	15
System Reliability Guidelines	15
Handling Static-sensitive Devices	16
Removing the Blade Server from the Intel® Blade Server Chassis SBCE	16
Opening the Blade Server Cover	17
Removing an Expansion Unit	18
Removing the Blade Server Bezel Assembly	19
Installing a SAS Hard Disk Drive	20
Removing a SAS Hard Disk Drive	21
Installing Memory Modules	22
Installing an Additional Microprocessor	24
Installing an I/O-expansion Card	28
Installing a Small-form-factor Expansion Card	29
Installing a Standard-form-factor Expansion Card	30
Installing an Expansion Unit	31
Completing the Installation	32
Installing the Blade Server Bezel Assembly	33

Closing the Blade Server Cover	34
Installing the Blade Server in an Intel® Blade Server Chassis SBCE	35
Updating the Blade Server Configuration	36
Input/output Connectors and Devices	36
Memory and I/O Expansion for the Intel® Server Compute Blade SBXD132	37
Intel® Blade Storage Expansion Module for the Intel® Server Compute Blade SBXD132	39
Installation Guidelines	39
System Reliability Considerations	40
Handling Static-sensitive Devices	40
Notices and Statements used in this Document.....	41
Installing the Expansion Unit	41
Installing the Expansion Unit Cover	43
Removing the Expansion Unit Cover	44
Installing a ServeRAID SAS Controller	45
Installing an I/O-expansion Card	47
Installing a Hot-swap SAS Hard Disk Drive.....	50
Completing the Installation	51
Configuring the Expansion Unit RAID Array.....	52
Using the Adaptec RAID Configuration Utility Program	52
Using the ServeRAID Manager Program	53
Light Path Diagnostics*	53
Configuring the Blade Server	57
Using the Configuration/Setup Utility program	57
Configuration/Setup Utility Menu Choices	58
Using Passwords	61
Using the PXE Boot Agent Utility Program	61
Firmware Updates	61
Configuring the Gigabit Ethernet Controllers	62
Blade Server Ethernet Controller Enumeration	62
Configuring a RAID Array	63
Using the LSI Logic Configuration Utility Program	63
Starting the LSI Logic Configuration Utility program	64
Installing the Operating System	65
Solving Problems	67
Diagnostic Tools Overview	67
A Warranty	69
Limited Warranty for Intel® Chassis Subassembly Products	69
Extent of Limited Warranty	69
Warranty Limitations and Exclusions	70
Limitations of Liability	70

How to Obtain Warranty Service	70
Telephone Support	71
Returning a Defective Product	71
B Regulatory and Compliance Information	73
Product Regulatory Compliance	73
Product Safety Compliance	73
Product EMC Compliance - Class A Compliance	74
Certifications / Registrations / Declarations	74
Product Regulatory Compliance Markings	75
Electromagnetic Compatibility Notices	76
FCC Verification Statement (USA)	76
Industry Canada (ICES-003)	77
Europe (CE Declaration of Conformity)	77
VCCI (Japan)	77
BSMI (Taiwan)	77
Korean Compliance (RRL)	78
Restriction of Hazardous Substances (RoHS) Compliance	78
End of Life / Product Recycling	78
C Getting Help	79
World Wide Web	79
Telephone	79
U.S. and Canada	79
Europe	79
In Asia-Pacific region	80
Japan	80
Latin America	80
D Safety Information	83
English	83
Server Safety Information	83
Safety Warnings and Cautions	83
Intended Application Uses	84
Site Selection	84
Equipment Handling Practices	84
Power and Electrical Warnings	84
System Access Warnings	85
Rack Mount Warnings	86
Electrostatic Discharge (ESD)	86
Other Hazards	87
Deutsch.....	88
Sicherheitshinweise für den Server	88
Sicherheitshinweise und Vorsichtsmaßnahmen	88
Zielbenutzer der Anwendung	89
Standortauswahl	89
Handhabung von Geräten	89

Warnhinweise für den Systemzugang	91
Elektrostatische Entladungen (ESD)	92
Andere Gefahren	93
Français	94
Consignes de sécurité sur le serveur	94
Sécurité: avertissements et mises en garde	94
Domaines d'utilisation prévus	95
Sélection d'un emplacement	95
Pratiques de manipulation de l'équipement	95
Décharges électrostatiques (ESD)	98
Autres risques	99
Español	100
Información de seguridad del servidor	100
Advertencias y precauciones sobre seguridad	100
Aplicaciones y usos previstos	101
Selección de la ubicación	101
Manipulación del equipo	101
Advertencias el acceso al sistema	103
Descarga electrostática (ESD)	104
E Installation/Assembly Safety Instructions	111
English	111
Deutsch	113
Français	116
Español	118
Italiano	120

Safety Information

Important Safety Instructions

Read all caution and safety statements in this document before performing any of the instructions. See also Intel® Server Boards and Server Chassis Safety Information on the *Intel® Server Deployment Toolkit CD* and/or at <http://support.intel.com/support/motherboards/server/sb/cs-010770.htm>.

Wichtige Sicherheitshinweise

Lesen Sie zunächst sämtliche Warnung und Sicherheitshinweise in diesem Dokument, bevor Sie eine der Anweisungen ausführen. Beachten Sie hierzu auch die Sicherheitshinweise zu Intel-Serverplatinen und Servergehäusen auf der *Intel® Server Deployment Toolkit CD* oder unter <http://support.intel.com/support/motherboards/server/sb/cs-010770.htm>.

Consignes de sécurité

Lisez attention toutes les consignes de sécurité et les mises en garde indiquées dans ce document avant de suivre toute instruction. Consultez Intel Server Boards and Server Chassis Safety Information sur le *Intel® Server Deployment Toolkit CD* ou bien rendez-vous sur le site <http://support.intel.com/support/motherboards/server/sb/cs-010770.htm>.

Instrucciones de seguridad importantes

Lea todas las declaraciones de seguridad y precaución de este documento antes de realizar cualquiera de las instrucciones. Vea Intel Server Boards and Server Chassis Safety Information en el *Intel® Server Deployment Toolkit CD* y/o en <http://support.intel.com/support/motherboards/server/sb/cs-010770.htm>.

重要安全指导

在执行任何指令之前，请阅读本文档中的所有注意事项及安全声明。和/或 <http://support.intel.com/support/motherboards/server/sb/cs-010770.htm> 上的 *Intel Server Boards and Server Chassis Safety Information* (《Intel 服务器主板与服务器机箱安全信息》)。

Warnings

These warnings and cautions apply whenever you remove the blade server enclosure cover to access components inside the system. Only a technically qualified person should maintain or configure the blade system.

Heed safety instructions: Before working with your server product, whether you are using this guide or any other resource as a reference, pay close attention to the safety instructions. You must adhere to the assembly instructions in this guide to ensure and maintain compliance with existing product certifications and approvals. Use only the described, regulated components specified in this guide. Use of other products / components will void the UL listing and other regulatory approvals of the product and will most likely result in noncompliance with product regulations in the region(s) in which the product is sold.

System power on/off: The power button DOES NOT turn off the system AC power. To remove power from the blade system, you must unplug the AC power cord from the wall outlet or the chassis. Make sure the AC power cord is unplugged before you open the chassis, add, or remove any components.

Hazardous conditions, devices and cables: Hazardous electrical conditions may be present on power, telephone, and communication cables. Turn off the blade system and disconnect the power cord, telecommunications systems, networks, and modems attached to the blade system before opening it. Otherwise, personal injury or equipment damage can result.

Electrostatic discharge (ESD) and ESD protection: ESD can damage disk drives, boards, and other parts. We recommend that you perform all procedures in this document only at an ESD workstation. If one is not available, provide some ESD protection by wearing an anti-static wrist strap attached to chassis ground (any unpainted metal surface) on your blade system when handling parts.

ESD and handling electronic devices: Always handle electronic devices carefully. They can be extremely sensitive to ESD. Do not touch the connector contacts.

Installing or removing jumpers: A jumper is a small plastic encased conductor that slips over two jumper pins. Some jumpers have a small tab on top that you can grip with your fingertips or with a pair of fine needle nosed pliers. If your jumpers do not have such a tab, take care when using needle nosed pliers to remove or install a jumper; grip the narrow sides of the jumper with the pliers, never the wide sides. Gripping the wide sides can damage the contacts inside the jumper, causing intermittent problems with the function controlled by that jumper. Take care to grip with, but not squeeze, the pliers or other tool you use to remove a jumper, or you may bend or break the pins on the board.

Reinstalling enclosure cover: To protect internal components and for proper cooling and airflow, the blade server cannot be inserted into the SBCE unit with the blade enclosure cover removed. Operating it without the enclosure cover in place can damage system parts.

1 Introduction

The Intel® Server Compute Blade SBXD132 is compatible with the Intel® Blade Server Chassis SBCE. This high-density, high-performance blade server is ideally suited for networking environments that require superior microprocessor performance, efficient memory management, flexibility, and reliable data storage.

This *Installation and User's Guide* provides information about:

- Setting up the blade server
- Starting and configuring the blade server
- Installing hardware options
- Installing the operating system
- Performing basic troubleshooting of the blade server

Packaged with this document are software CDs that help you to configure hardware, install device drivers, and install the operating system. To download the latest device drivers, go to <http://support.intel.com/support/>.

The blade server comes with a limited warranty. For information about the terms of the warranty and getting service and assistance, see [Appendix A, “Warranty” on page 69](#). You can obtain up-to-date information about the blade server at <http://support.intel.com/support/>.

If firmware and documentation updates are available, you can download them from <http://support.intel.com/support/>. The blade server might have features that are not described in the documentation that comes with the blade server, and the documentation might be updated occasionally to include information about those features, or technical updates might be available to provide additional information that is not included in the blade server documentation. To check for updates, go to <http://support.intel.com/support/>. For firmware and documentation updates, under **Download Center**, type SBXD132 and click **Search**.

Note: Changes are made periodically to the Intel Web site. Procedures for locating firmware and documentation might change from what is described in this document.

Note: The illustrations in this document might differ slightly from the hardware.

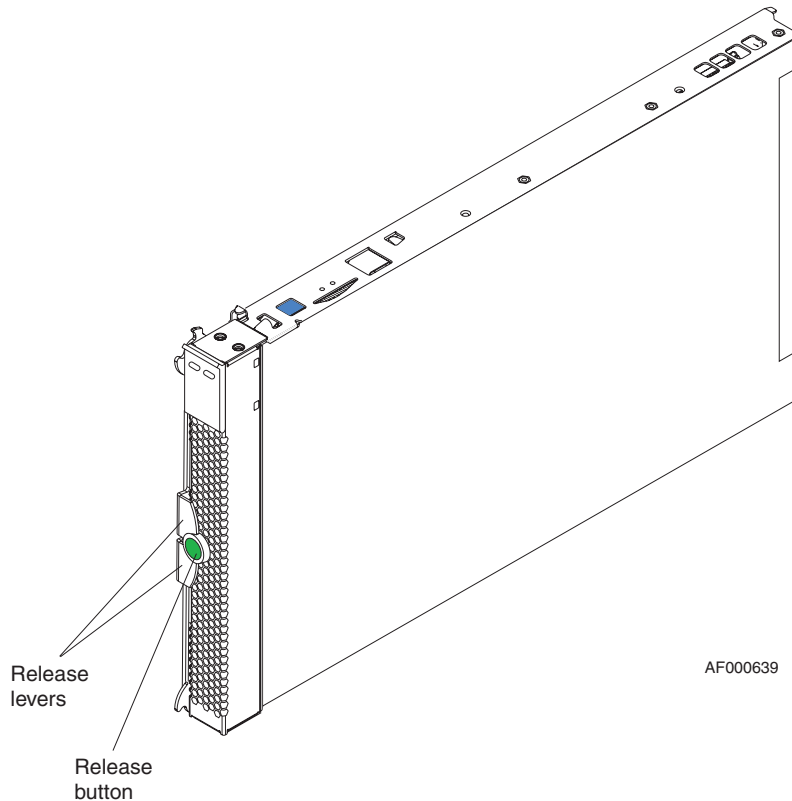

Related Documentation

This *Installation and User's Guide* contains general information about the blade server, including how to install supported options and how to configure the blade server. The following documentation also comes with the blade server:

- *Hardware Maintenance and Troubleshooting Guide*
This document is in Portable Document Format (PDF) on the Resource CD. It contains information to help you solve problems yourself, and it contains information for service technicians.
- *Safety Information*
This document is in PDF format on the Resource CD. It contains translated caution and danger statements. Each caution and danger statement that appears in the documentation has a number that you can use to locate the corresponding statement in your language in the *Safety Information* document.

Depending on your blade server product, additional documents might be included on the Resource CD.

The blade server might have features that are not described in the documentation that comes with the server. The documentation might be updated occasionally to include information about those features, or technical updates might be available to provide additional information that is not included in the blade server documentation. The most recent versions of all blade server documentation are at <http://support.intel.com/support/>. In addition to the documentation in this library, be sure to review the *Intel® Blade Server Chassis SBCE Installation and User's Guide* for information to help you prepare for system installation and configuration. This document is available at <http://support.intel.com/support/>.

The Resource CD

You can run the Resource CD on any personal computer that meets the hardware and software requirements.

The Resource CD contains documentation for your blade server in PDF format.

Hardware and Software Requirements

The Resource CD requires the following minimum hardware and software:

- Microsoft® Windows® NT 4.0 (with Service Pack 3 or later), Windows 2000, or Red Hat Linux.
- 100-MHz microprocessor.
- 32 MB of RAM.
- Adobe Acrobat Reader 3.0 (or later) or xpdf, which comes with Linux operating systems. Acrobat Reader software is included on the Resource CD.

Notices and Statements Used in this Document

The following notices and statements are used in this document:

- **Note:** These notices provide important tips, guidance, or advice.
- **Important:** These notices provide information or advice that might help you avoid inconvenient or problem situations.
- **Attention:** These notices indicate possible damage to programs, devices, or data. An attention notice is placed just before the instruction or situation in which damage could occur.
- **Caution:** These statements indicate situations that can be potentially hazardous to you. A caution statement is placed just before the description of a potentially hazardous procedure step or situation.
- **Danger:** These statements indicate situations that can be potentially lethal or extremely hazardous to you. A danger statement is placed just before the description of a potentially lethal or extremely hazardous procedure step or situation.

Features and Specifications

The following table provides a summary of the features and specifications of the blade server.

Notes:

- *Power, cooling, removable-media drives, external ports, and advanced system management are provided by the SBCE unit.*
- *The operating system in the blade server must provide USB support for the blade server to recognize and use the removable-media drives and front-panel USB ports. The SBCE unit uses USB for internal communications with these devices.*

<p>Microprocessor:</p> <p>Supports up to two dual-core/quad-core Intel® Xeon® microprocessors</p> <p>NOTE: Use the Configuration/Setup Utility program to determine the type and speed of the microprocessors in your blade server.</p> <p>Memory:</p> <ul style="list-style-type: none"> • Dual-channel DIMMs: 4 DIMM slots • Type: fully-buffered double-data rate (FB-DDR2), PC2-4200, ECC SDRAM registered x4 DIMMs • Supports 512 MB, 1 GB, 2 GB, and 4 GB DIMMs (as of the date of this publication) with up to 16 GB of total memory in the system board • Additional memory support when an optional Intel® Blade Server Memory and I/O Expansion Blade is installed <p>Drives:</p> <p>Support for two internal small-form-factor Serial Attached SCSI (SAS) drives</p>	<p>Integrated functions:</p> <ul style="list-style-type: none"> • Dual Gigabit Ethernet controllers • Expansion card interface • Local service processor: Baseboard management controller (BMC) with Intelligent Platform Management Interface (IPMI) firmware • ATI* RN-50 video controller • LSI* 1064E Serial Attached SCSI (SAS) controller • Light path diagnostics • RS-485 interface for communication with the management module • Serial over LAN (SOL) • 4 USB buses for communication with keyboard, mouse, and removable media drives <p>Electrical Input:</p> <ul style="list-style-type: none"> • 12 V dc 	<p>Environment:</p> <ul style="list-style-type: none"> • Air temperature: <ul style="list-style-type: none"> – Blade server on: 10° to 35° C (50° to 95° F). Altitude: 0 to 914 m (2998.69 ft) – Blade server on: 10° to 32° C (50° to 90° F). Altitude: 914 m to 2134 m (2998.69 ft to 7000 ft) – Blade server off: -40° to 60° C (-40° to 140° F) • Humidity: <ul style="list-style-type: none"> – Blade server on: 8% to 80% Blade server off: 5% to 80% <p>Size:</p> <ul style="list-style-type: none"> • Height: 24.5 cm (9.7 inches) • Depth: 44.6 cm (17.6 inches) • Width: 2.9 cm (1.14 inches) • Maximum weight: 5.4 kg (12 lb) <p>Predictive Failure Analysis (PFA) alerts:</p> <ul style="list-style-type: none"> • Microprocessor • Memory • Hard disk drives
---	---	--

What Your Blade Server Offers

The design of the blade server takes advantage of advancements in memory management and data storage. The blade server uses the following features and technologies:

- **Baseboard management controller (BMC)**

The baseboard management controller (BMC) is on the system board of the blade server. The BMC operates as the service processor for the blade server and performs several tasks, including the following functions:

- Provides RS-485 interfaces to the management module
- Provides support for:
 - Intelligent Platform Management Interface (IPMI)
 - The operating system
 - Power control and advanced power management
 - Reliability, availability, and serviceability (RAS) features
 - Serial over LAN (SOL)

- **Disk drive support**

The blade server supports up to two 2.5-inch small form factor (SFF) Serial Attached SCSI (SAS) hard disk drives.

- **Impressive performance using the latest microprocessor technology**

The blade server supports up to two dual-core/quad-core Intel® Xeon processor microprocessors.

- **Integrated network support**

The blade server comes with two integrated Broadcom* BCM5708S Gigabit Ethernet controllers, which support connection to a 10-Mbps, 100-Mbps, or 1000-Mbps network through an Ethernet-compatible switch module in the SBCE unit. The controller supports Wake on LAN® technology.

- **I/O-expansion**

The blade server has connectors on the system board for optional expansion cards for adding more network communication capabilities to the blade server.

- **Large system memory**

The blade server system board supports up to 16 GB of system memory. The memory controller provides support for up to four industry-standard fully-buffered double-data rate (FB-DDR2), PC2-4200, ECC SDRAM registered x4 DIMMs installed in the system board. The controller is able to support additional memory DIMMs installed in an optional expansion unit. For the most current list of supported DIMMs, see the Intel® Server Compute Blade SBXD132 *Memory List Test Report Summary* at <http://support.intel.com/support/>.

- **Light path diagnostics**

Light path diagnostics provides light-emitting diodes (LEDs) to help you diagnose problems. For more information, see the *Intel® Server Compute Blade SBXD132 Hardware Maintenance and Troubleshooting Guide*.

- **PCI Express**

PCI Express is a fully serial interface that can be used for universal connectivity for use as a chip-to-chip interconnect, I/O interconnect for adapters, and an I/O attachment point to Gigabit-networking devices. PCI Express bridges a PCI Express bus to a PCIX bus and converts the transactions on the PCI bus to transactions on the PCIX bus. Using the expansion card connector you can add additional LAN interfaces. The expansion card connector supports PCI-X 133 and bridges PCI Express into PCI-X 133.

- **Power throttling**

Each blade server is powered by two redundant power-supply modules. By enforcing a power policy known as power domain oversubscription, the SBCE unit can share the power load between two power modules to ensure efficient power for each device in the SBCE unit. This policy is enforced when the initial power is applied to the SBCE unit or when a blade server is inserted into the SBCE unit. You can configure and monitor the power environment by using the management module. For more information about configuring and using power throttling, see the management-module documentation or <http://support.intel.com/support/>.

Reliability, Availability, and Serviceability Features

Three of the most important features in server design are reliability, availability, and serviceability (RAS). These RAS features help to ensure the integrity of the data that is stored in the blade server, the availability of the blade server when you need it, and the ease with which you can diagnose and correct problems.

The blade server has the following RAS features:

- Advanced Configuration and Power Interface (ACPI)
- Automatic error retry or recovery
- Built-in monitoring for temperature, voltage, hard disk drives, and flash drives
- x4 SDDC
- Customer support center 24 hours per day, 7 days a week¹
- Customer-upgradeable basic input/output system (BIOS) code and diagnostics
- Diagnostic support of Ethernet controllers
- ECC memory
- ECC protection on the L2 cache
- Error codes and messages

1. Service availability will vary by country. Response time will vary depending on the number and nature of incoming calls.

- Failover Ethernet support
- Hot-spare memory
- Hot-swap drives on optional storage expansion unit
- Light path diagnostics feature
- Memory parity testing
- Microprocessor built-in self-test (BIST) during power-on self-test (POST)
- Microprocessor presence detection
- Microprocessor serial number access
- Power policy support
- Power-on self-test (POST)
- Predictive Failure Analysis (PFA) alerts
- ROM Resident Diagnostics
- SDRAM with serial presence detect (SPD) and vital product data (VPD)
- Service processor that communicates with the management module to enable remote blade server management
- System error logging
- Wake on LAN capability

Major Components of the Blade Server

You must remove the blade server from the SBCE unit and remove the cover to see the components.

The following illustration shows the major components of the blade server.

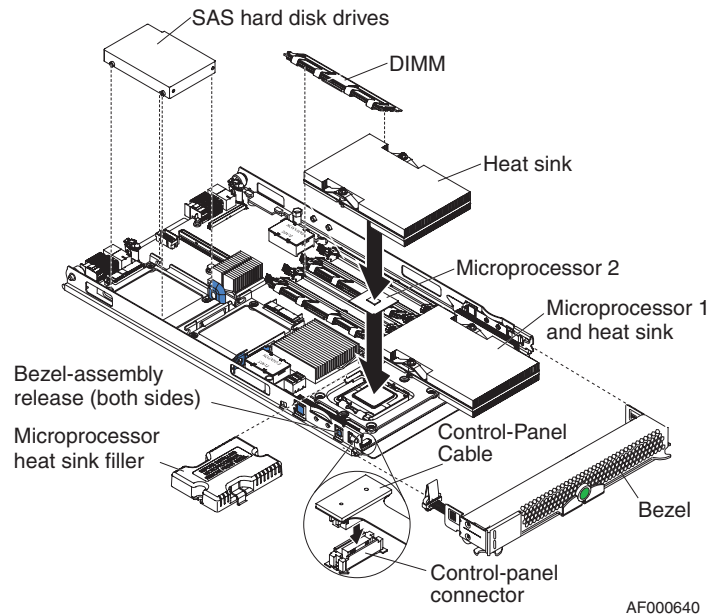

2 Power, Controls, Jumpers, Switches, and Indicators

This chapter describes the power features, how to turn on and turn off the blade server, and what the controls and indicators mean. This chapter also identifies the system-board connectors.

Turning on the Blade Server

After you connect the blade server to power through the SBCE unit, the blade server can start in any of the following ways:

- You can press the power-control button on the front of the blade server (behind the control panel door, see [“Understanding the Control Panel and LEDs” on page 10](#)) to start the blade server.

Notes:

1. *Wait until the power-on LED on the blade server flashes slowly before pressing the power-control button. While the service processor in the management module is initializing, the power-on LED does not flash, and the power-control button on the blade server does not respond.*
 2. *While the blade server is starting, the power-on LED on the front of the blade server is lit. See [“Understanding the Control Panel and LEDs” on page 10](#) for the power-on LED states.*
- If a power failure occurs, the SBCE unit and then the blade server can start automatically when power is restored, if the blade server is configured through the management module to do so.
 - You can turn on the blade server remotely by using the management module.
 - If the blade server is connected to power (the power-on LED is flashing slowly), the operating system supports the Wake on LAN feature, and the Wake on LAN feature has not been disabled through the management module, the Wake on LAN feature can turn on the blade server. However, the blade server can only receive the Wake on LAN command through the Ethernet ports that are integrated on the system board, not through the Ethernet ports on an installed I/O expansion card.

Turning off the Blade Server

When you turn off the blade server, it is still connected to power through the SBCE unit. The blade server can respond to requests from the service processor, such as a remote request to turn on the blade server. To remove all power from the blade server, you must remove it from the SBCE unit.

Shut down the operating system before you turn off the blade server. See the operating-system documentation for information about shutting down the operating system.

The blade server can be turned off in any of the following ways:

- You can press the power-control button on the blade server (behind the control panel door, see “[Understanding the Control Panel and LEDs](#)” on page 10). This starts an orderly shutdown of the operating system, if this feature is supported by the operating system.

Note: *After turning off the blade server, wait at least 5 seconds before you press the power-control button to turn on the blade server again.*

- If the operating system stops functioning, you can press and hold the power-control button for more than 4 seconds to turn off the blade server.
- The management module can turn off the blade server.
 - If the system is not operating correctly, the management module will automatically turn off the blade server.
 - Through the management-module Web interface, you can also configure the management module to turn off the blade server. For additional information, see the *Intel® Blade Server Management Module SBCECMM: Installation and User’s Guide*.

Understanding the Control Panel and LEDs

This section describes the controls and LEDs on the blade server.

Note: *The control panel door is shown in the closed (normal) position in the following illustration. To access the power-control button, you must open the control panel door.*

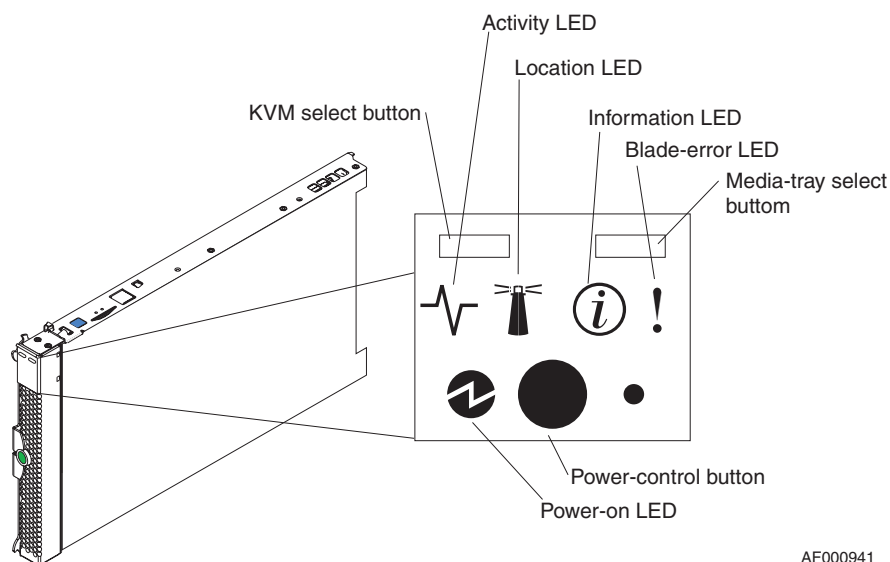

AF000941

Keyboard/video/mouse (KVM) select button: Press this button to associate the shared SBCE unit keyboard port, video port, and mouse port with the blade server. The LED on this button flashes while the request is being processed, and then is lit when the ownership of the keyboard, video, and mouse has been transferred to the blade server. It can take approximately 20 seconds to switch the keyboard, video, and mouse control to the blade server.

Using a keyboard that is directly attached to the management-module, you can press keyboard keys in the following sequence to switch KVM control between blade servers:

NumLock NumLock *blade_server_number* Enter

Where *blade_server_number* is the two-digit number for the blade bay in which the blade server is installed. A blade server that occupies more than one blade bay is identified by the lowest bay number that it occupies.

If there is no response when you press the KVM select button, you can use the management-module Web interface to determine whether local control has been disabled on the blade server.

Notes:

1. *The operating system in the blade server must provide USB support for the blade server to recognize and use the keyboard and mouse, even if the keyboard and mouse have PS/2[®]-style connectors.*
2. *If you install a supported Microsoft* Windows* operating system on the blade server while it is not the current owner of the keyboard, video, and mouse, a delay of up to 1 minute occurs the first time that you switch the keyboard, video, and mouse to the blade server. All subsequent switching takes place in the normal KVM switching time frame (up to 20 seconds).*

Media-tray select button: Press this button to associate the shared SBCE unit media tray (removable-media drives and front-panel USB ports) with the blade server. The LED on the button flashes while the request is being processed, and then is lit when the ownership of the media tray has been transferred to the blade server. It can take approximately 20 seconds for the operating system in the blade server to recognize the media tray.

If there is no response when you press the media-tray select button, you can use the management-module Web interface to determine whether local control has been disabled on the blade server.

Note: *The operating system in the blade server must provide USB support for the blade server to recognize and use the removable-media drives and front-panel USB ports.*

Activity LED: When this green LED is lit, it indicates that there is activity on the hard disk drive, or network.

Location LED: When this blue LED is lit, it has been turned on by the system administrator to aid in visually locating the blade server. The location LED on the SBCE unit is lit also. The location LED can be turned off through the management-module Web interface.

Information LED: When this amber LED is lit, it indicates that information about a system error for the blade server has been placed in the management-module event log. The information LED can be turned off through the management-module Web interface.

Blade-error LED: When this amber LED is lit, it indicates that a system error has occurred in the blade server. The blade-error LED will turn off only after the error is corrected.

Power-control button: This button is behind the control panel door. Press this button to turn on or turn off the blade server.

Note: The power-control button has effect only if local power control is enabled for the blade server. Local power control is enabled and disabled through the management-module Web interface.

Power-on LED: This green LED indicates the power status of the blade server in the following manner:

- Flashing rapidly: The service processor (BMC) on the blade server is communicating with the management module.
- Flashing slowly: The blade server has power but is not turned on.
- Lit continuously: The blade server has power and is turned on.

Blade Server Connectors

The following illustration shows the system-board components, including connectors for user-installable options, for the blade server.

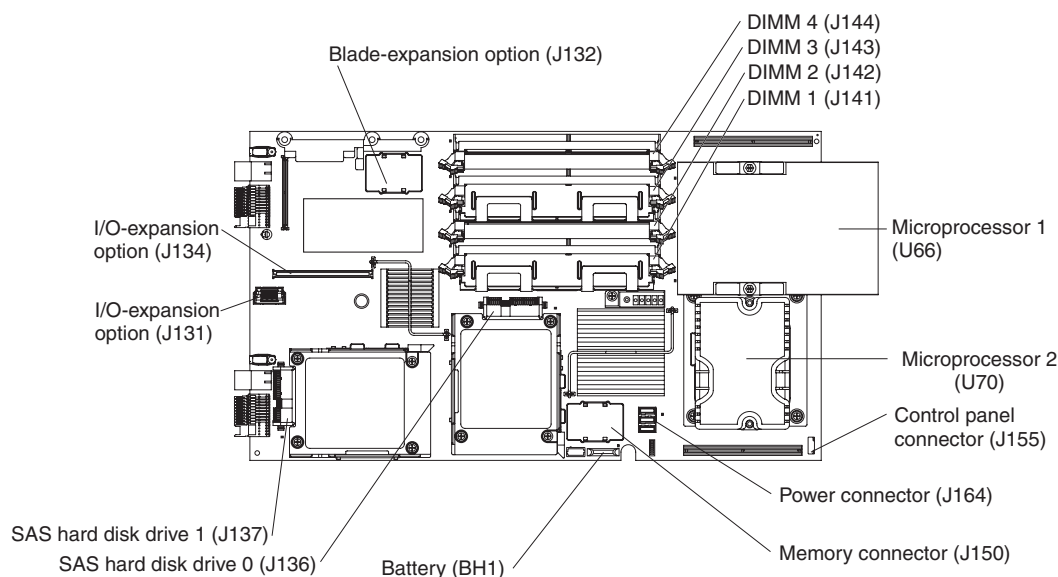

AF002051

The following illustration shows components for the optional Intel® Blade Server Memory and I/O Expansion Blade.

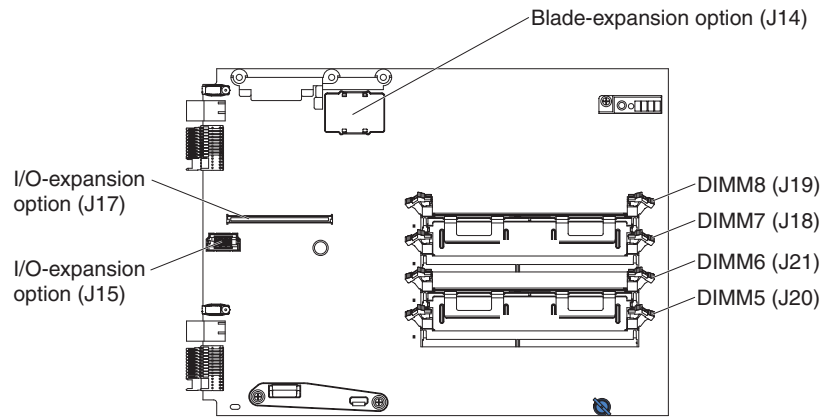

3 Installing Options

This chapter provides instructions for installing hardware options in the blade server. Some option-removal instructions are provided in case you need to remove one option to install another.

Installation Guidelines

Before you begin installing options in the blade server, read the following information:

- Read the safety information beginning on page [vii](#) and the guidelines in “[Handling Static-sensitive Devices](#)” on page 16. This information will help you work safely with the blade server and options.
- When you install your new blade server, take the opportunity to download and apply the most recent firmware updates. This step will help to make sure that any known issues are addressed and that your blade server is ready to function at maximum levels of performance. To download firmware updates for your server, go to <http://support.intel.com/support/>.
- Observe good housekeeping in the area where you are working. Place removed covers and other parts in a safe place.
- Back up all important data before you make changes to disk drives.
- Before you remove a blade server from the SBCE unit, you must shut down the operating system and turn off the blade server. You do not have to shut down the SBCE unit itself.
- When you are finished working on the blade server, reinstall all safety shields, guards, labels, and ground wires.
- For a list of supported options for the blade server, go to <http://support.intel.com/support/>.

System Reliability Guidelines

To help ensure proper cooling and system reliability, make sure that the following requirements are met:

- Each microprocessor socket always contains either a microprocessor heat-sink filler or a microprocessor and heat sink. If the blade server has only one microprocessor, it must be installed in microprocessor socket 1.
- You do not operate the SBCE unit without a blade server, expansion unit, or filler blade installed in each blade bay to ensure proper cooling. See the documentation for your SBCE unit for additional information.
- The blade server battery must be operational. If the battery becomes defective, replace it immediately. For instructions, see the *Intel® Server Compute Blade SBXD132 Hardware Maintenance and Troubleshooting Guide*.

Handling Static-sensitive Devices

Warning: *Static electricity can damage the blade server and other electronic devices. To avoid damage, keep static-sensitive devices in their static-protective packages until you are ready to install them.*

To reduce the possibility of damage from electrostatic discharge, observe the following precautions:

- Limit your movement. Movement can cause static electricity to build up around you.
- Handle the device carefully, holding it by its edges or its frame.
- Do not touch solder joints, pins, or exposed circuitry.
- Do not leave the device where others can handle and damage it.
- While the device is still in its static-protective package, touch it to an *unpainted* metal part of the SBCE unit or any *unpainted* metal surface on any other grounded rack component in the rack in which you are installing the device for at least 2 seconds. This drains static electricity from the package and from your body.
- Remove the device from its package and install it directly into the blade server without setting it down. If it is necessary to set down the device, put it back into its static-protective package. Do not place the device on the blade server cover or on a metal surface.
- Take additional care when you handle devices during cold weather. Heating reduces indoor humidity and increases static electricity.

Removing the Blade Server from the Intel® Blade Server Chassis SBCE

The following illustration shows how to remove a blade server from a SBCE unit. The appearance of your SBCE unit might be different, see the documentation for your SBCE unit for additional information.

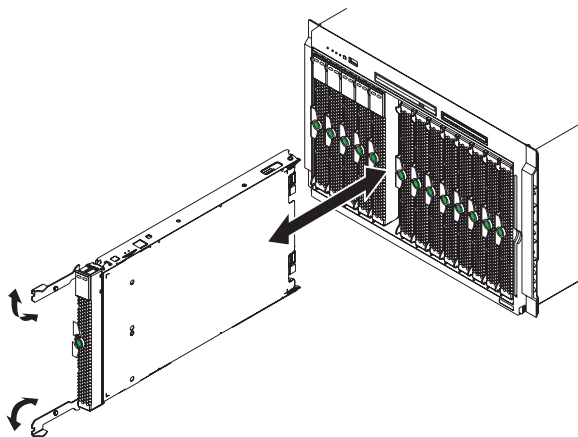

AF000944

Warning: To maintain proper system cooling, do not operate the SBCE unit without a blade server, expansion unit, or blade filler installed in each blade bay.

Note the bay number. Reinstalling a blade server into a different bay than the one from which it was removed could have unintended consequences. Some configuration information and update options are established according to bay number; if you reinstall the blade server into a different bay, you might need to reconfigure the blade server.

To remove the blade server, complete the following steps:

1. If the blade server is operating, shut down the operating system; then, press the power-control button (behind the blade server control panel door) to turn off the blade server (see [“Turning off the Blade Server”](#) on page 9 for more information).

Caution: Wait at least 30 seconds, until the hard disk drives stop spinning, before proceeding to the next step.

2. Open the two release handles as shown in the illustration. The blade server moves out of the bay approximately 0.6 cm (0.25 inch).
3. Pull the blade server out of the bay.
4. Place either a blade filler or another blade in the bay within 1 minute.

Opening the Blade Server Cover

Note: If the blade server has an expansion unit installed in place of the cover, remove it (see [“Removing an Expansion Unit”](#) on page 18).

The following illustration shows how to open the cover on a blade server.

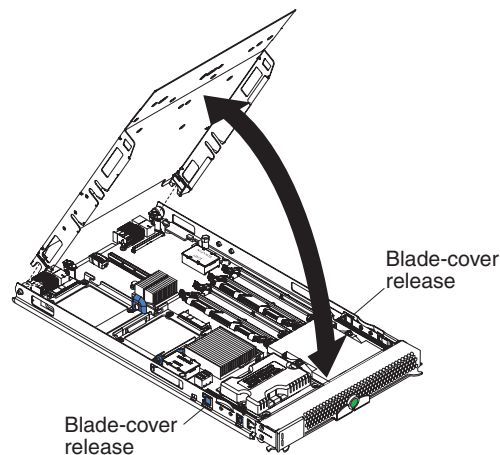

AF000641

To open the blade server cover, complete the following steps:

1. Read the safety information beginning on page vii and [“Installation Guidelines”](#) on page 15.

2. If the blade server is installed in a SBCE unit, remove it (see [“Removing the Blade Server from the Intel® Blade Server Chassis SBCE”](#) on page 16 for instructions).
3. Carefully lay the blade server down on a flat, static-protective surface, with the cover side up.
4. Press the blade-cover release on each side of the blade server or expansion unit and lift the cover open, as shown in the illustration.
5. Lay the cover flat, or lift it from the blade server and store for future use.

Caution: *Hazardous energy is present when the blade server is connected to the power source. Always replace the blade cover before installing the blade server.*

Removing an Expansion Unit

The following illustration shows how to remove an expansion unit from a blade server.

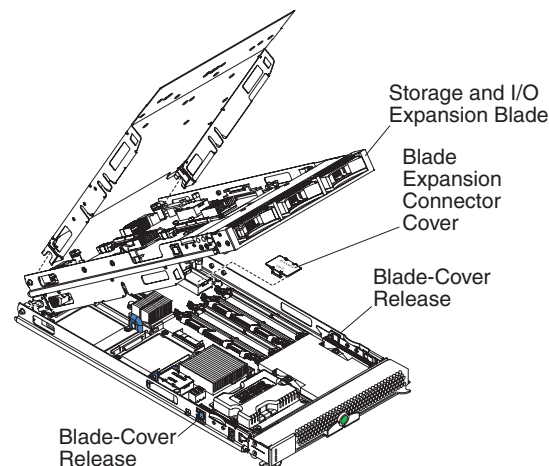

AF000642

To remove the expansion unit, complete the following steps:

1. Read the safety information beginning on page vii and [“Installation Guidelines”](#) on page 15.
2. If the blade server is installed in a SBCE unit, remove it (see [“Removing the Blade Server from the Intel® Blade Server Chassis SBCE”](#) on page 16 for instructions).
3. Carefully lay the blade server down on a flat, static-protective surface, with the cover side up.
4. Open the blade server cover, if one is installed (see [“Opening the Blade Server Cover”](#) on page 17 for instructions).
5. Remove the expansion unit:
 - a. Press the blade-cover release on each side of the blade server.

- b. Use the extraction device on the expansion unit, if one is present, to disengage the expansion unit from the system board. These extraction devices can be of several types, including thumb screws or levers.
- c. Rotate the expansion unit open, as shown in the illustration; then, lift the expansion unit from the blade server.

Removing the Blade Server Bezel Assembly

To install certain options, you must first remove the blade server bezel assembly. The following illustration shows how to remove the bezel assembly.

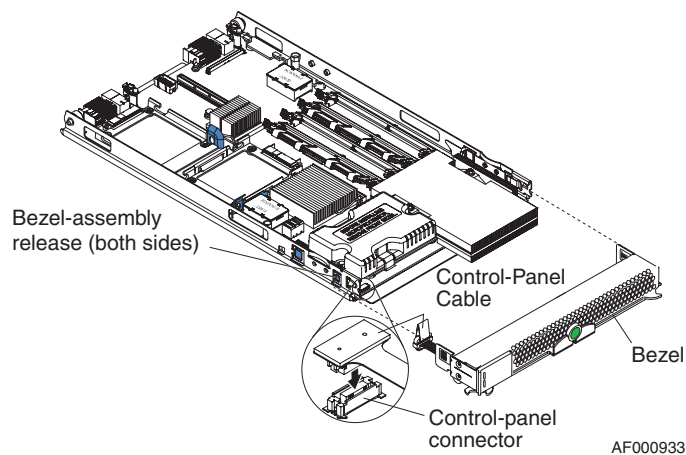

To remove the blade server bezel assembly, complete the following steps:

1. Read the safety information beginning on page [vii](#) and “[Installation Guidelines](#)” on [page 15](#).
2. Open the blade server cover (see “[Opening the Blade Server Cover](#)” on [page 17](#) for instructions).
3. Press the bezel-assembly release and pull the bezel assembly away from the blade server approximately 1.2 cm (0.5 inch).
4. Disconnect the control-panel cable from the control-panel connector.
5. Pull the bezel assembly away from the blade server.
6. Store the bezel assembly in a safe place.

Installing a SAS Hard Disk Drive

The blade server has two connectors on the system board for installing optional SFF SAS hard disk drives.

Depending on the blade server model, at least one SAS hard disk drive might already be installed. If the blade server is equipped with one SAS hard disk drive, you can install an additional SAS hard disk drive. These two SAS hard disk drives can be used to implement and manage a redundant array of independent disks (RAID) level-1 array. See [“Configuring a RAID Array” on page 63](#) for information about SAS RAID configuration.

The following illustration shows how to install a SAS hard disk drive.

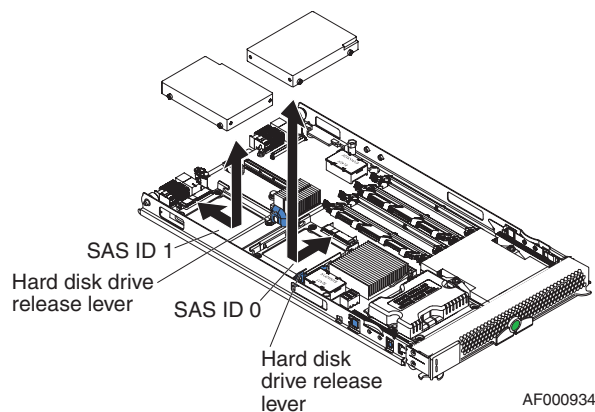

Note: Do not install a SAS hard disk drive in SAS connector 1 (SAS ID 1) if you intend to also install an optional standard-form-factor expansion card. The standard-form-factor expansion card occupies the same area as the second hard disk drive.

To install a SAS hard disk drive, complete the following steps:

1. Read the safety information beginning on page [vii](#) and [“Installation Guidelines” on page 15](#).
2. Shut down the operating system, turn off the blade server, and remove the blade server from the SBCE unit (see [“Removing the Blade Server from the Intel® Blade Server Chassis SBCE” on page 16](#) for instructions).
3. Carefully lay the blade server on a flat, static-protective surface.
4. Open the blade server cover (see [“Opening the Blade Server Cover” on page 17](#) for instructions).
5. Locate SAS connector 0 (J136) or SAS connector 1 (J137).
6. If a standard-form-factor expansion card is installed in the SAS connector 1 location, complete the following steps:
 - a. Remove the expansion card (see the illustration in [“Installing a Standard-form-factor Expansion Card” on page 30](#)) and its mounting bracket, and save the screws that secure the mounting bracket to the system board. Store the screws in a safe place.

- b. Install the SAS connector 1 drive tray. Secure the drive tray to the system board with the screws from the option kit.

Caution: Do not press on the top of the drive. Pressing on the top might damage the drive.

7. Put the drive into the tray and push it, from the rear edge of the drive, into the connector until the drive moves past the lever at the back of the tray.

If you have other options to install or remove, do so now; otherwise, go to [“Completing the Installation” on page 32](#).

Removing a SAS Hard Disk Drive

The following illustration shows how to remove a SAS hard disk drive.

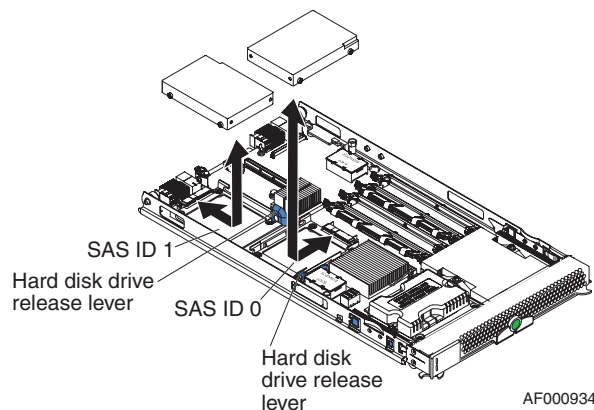

To remove a SAS hard disk drive, complete the following steps:

1. Read the safety information beginning on page [vii](#) and [“Installation Guidelines” on page 15](#).
2. Shutdown the operating system, turn off the blade server, and remove the blade server from the SBCE unit (see [“Removing the Blade Server from the Intel® Blade Server Chassis SBCE” on page 16](#) for instructions).
3. Carefully lay the blade server on a flat, static-protective surface.
4. Open the blade server cover (see [“Opening the Blade Server Cover” on page 17](#) for instructions).
5. Locate SAS connector 0 (J136) or SAS connector 1 (J137). Slowly pull the blue lever at the back of the hard disk drive tray away from the hard disk drive to disengage the drive from its tray.
6. From the rear edge of the drive, slide the drive out of the SAS connector.

Installing Memory Modules

The following notes describe the types of dual inline memory modules (DIMMs) that the blade server supports and other information that you must consider when installing DIMMs:

- The system board contains four DIMM connectors. If an optional Intel® Blade Server Memory and I/O Expansion Blade is installed on your blade server, it provides four additional DIMM connectors. The server supports two-way memory interleaving.
- The DIMM options that are available for the blade server are 512 MB, 1 GB, 2 GB and 4 GB. Depending on the memory configuration set in blade server BIOS, the blade server can support a minimum of 1 GB and a maximum of 16 GB of system memory in the system board and a maximum of 32 GB of system memory when an optional Intel® Blade Server Memory and I/O Expansion Blade is installed.
- For blade servers with no Memory and I/O Expansion Blade, when you install memory, you must install a pair of matched DIMMs. Install the DIMMs in the following order:

Pair	DIMM connectors
First	1 (J141) and 3 (J143)
Second	2 (J142) and 4 (J144)

- To set up a non-mirrored memory configuration for a blade server with a Memory and I/O Expansion Blade, when you install memory, you must install a pair of matched DIMMs. Install the DIMMs in the following order:

Pair	DIMM connectors
First	1 (system board J141) and 3 (system board J143)
Second	1 (Memory and I/O Expansion Blade J18) and 3 (Memory and I/O Expansion Blade J20)
Third	2 (system board J142) and 4 (system board J144)
Fourth	2 (Memory and I/O Expansion Blade J19) and 4 (Memory and I/O Expansion Blade J21)

- To set up a mirrored memory configuration for a blade server with a Memory and I/O Expansion Blade, when you install memory, you must install matched DIMMs in groups of four. Install the DIMMs in the following order:

Pair	DIMM connectors
First	1 (system board J141) and 3 (system board J143) 1 (Memory and I/O Expansion Blade J18) and 3 (Memory and I/O Expansion Blade J20)

Pair	DIMM connectors
Second	2 (system board J142) and 4 (system board J144) 2 (Memory and I/O Expansion Blade J19) and 4 (Memory and I/O Expansion Blade J21)

- All DIMMs in a pair or group must be the same size, speed, type, technology, and physical design. You can mix compatible DIMMs from different manufacturers.
- All DIMMs must have the same speed. However, different pairs or groups of DIMMs do not have to be of the same size, type, technology, and physical design.
- Install only fully-buffered double-data rate dual-channel (FB-DDR2), PC2-4200, registered SDRAM with ECC DIMMs. For a current list of supported DIMMs for the blade server, see <http://support.intel.com/support/>.
- Installing or removing DIMMs changes the configuration information for the blade server. After installing or removing a DIMM, you must change and save the new configuration information by using the Configuration/Setup Utility program. When you restart the blade server, it displays a message indicating that the memory configuration has changed. Start the Configuration/Setup Utility program and select **Save Settings** (see “Configuration/Setup Utility Menu Choices” on page 58 for more information).

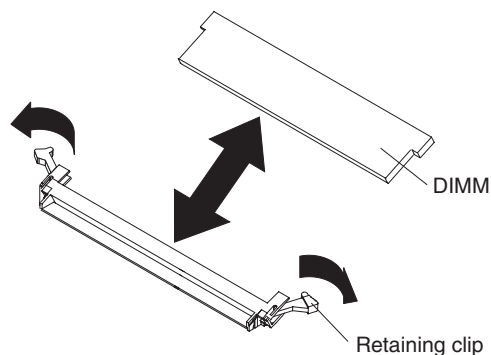

To install a DIMM, complete the following steps:

1. Read the safety information beginning on page vii and “Installation Guidelines” on page 15.
2. Read the documentation that comes with the DIMMs.
3. Shut down the operating system, turn off the blade server, and remove the blade server from the SBCE unit (see “Removing the Blade Server from the Intel® Blade Server Chassis SBCE” on page 16 for instructions).
4. Carefully lay the blade server on a flat, static-protective surface.
5. Open the blade server cover (see “Opening the Blade Server Cover” on page 17 for instructions).

6. If a Memory and I/O Expansion Blade is installed and you are installing DIMMs on the system board, remove the expansion blade (see “[Removing an Expansion Unit](#)” on page 18).
7. Locate the DIMM connectors (see the illustrations in “[Blade Server Connectors](#)” on page 12). Determine the connectors into which you will install the DIMMs.
8. Touch the static-protective package that contains the DIMM to any *unpainted* metal surface on the SBCE unit or any *unpainted* metal surface on any other grounded rack component in the rack in which you are installing the DIMM for at least 2 seconds; then, remove the DIMM from its package.
9. To install the DIMMs, repeat the following steps for each DIMM that you install:
 - a. Turn the DIMM so that the DIMM keys align correctly with the connector on the system board.

Caution: *To avoid breaking the retaining clips or damaging the DIMM connectors, handle the clips gently.*
 - b. Insert the DIMM by pressing the DIMM along the guides into the connector. Make sure that the retaining clips snap into the closed positions.

Important: *If there is a gap between the DIMM and the retaining clips, the DIMM has not been correctly installed. In this case, open the retaining clips and remove the DIMM; then, reinsert the DIMM.*
10. If you have other options to install or remove, do so now; otherwise, go to “[Completing the Installation](#)” on page 32.

If memory is installed in the Memory and I/O Expansion Blade, it can be configured to provide memory mirroring using the Configuration/Setup Utility program. See **Advanced Setup** -> **Memory Settings** under “[Configuration/Setup Utility Menu Choices](#)” on page 58 for more information.

Installing an Additional Microprocessor

The blade server comes with at least one microprocessor. If the blade server comes with one microprocessor, you can install a second microprocessor. If more than one microprocessor is installed, the blade server can now operate as a symmetric multiprocessing (SMP) server. With SMP, certain operating systems and application programs can distribute the processing load between the microprocessors.

Notes:

1. You can not remove the single microprocessor and replace it with a different type of microprocessor of greater or lesser speed.
2. If you install a second microprocessor, you must install the same microprocessor type and speed as the first microprocessor.

To use SMP, obtain an SMP-capable operating system. For a list of supported operating systems and other options, go to <http://support.intel.com/support/>.

The following notes describe the type of microprocessor that the server supports and other information that you must consider when installing a microprocessor:

- Always install microprocessors that have the same cache size and type, the same clock speed, and identical internal and external clock frequencies (including system bus speed).
- Make sure that the microprocessor with the lowest feature set is the startup (bootstrap) microprocessor, which is installed in the microprocessor 1 socket (U66).
- For a list of microprocessors that the blade server supports, go to <http://support.intel.com/support/>.
- Before installing a new microprocessor, download and install the most current level of BIOS code, from <http://support.intel.com/support/>.
- The microprocessors terminate themselves; therefore, no terminator card is required if microprocessor socket 2 is empty. However, for proper airflow, this socket must contain a microprocessor heat-sink filler, sometimes called a microprocessor baffle.
- The microprocessor speeds are automatically set for this server; therefore, you do not have to set any microprocessor frequency-selection jumpers or switches.

The following illustration shows how to install the second microprocessor on the system board for the blade server.

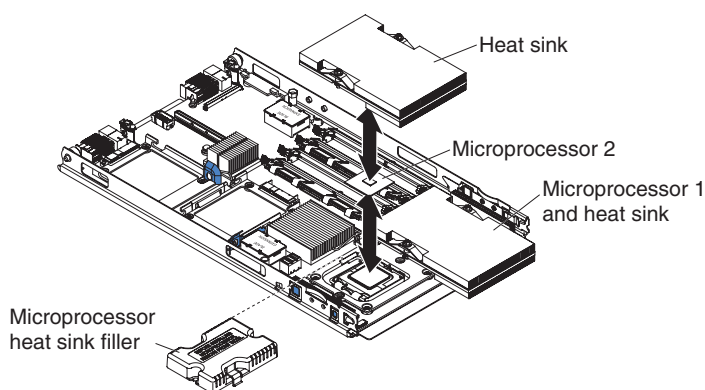

To install an additional microprocessor, complete the following steps:

1. Read the safety information beginning on page [vii](#) and “[Installation Guidelines](#)” on [page 15](#).
2. Shut down the operating system, turn off the blade server, and remove the blade server from the SBCE unit (see “[Removing the Blade Server from the Intel® Blade Server Chassis SBCE](#)” on [page 16](#) for instructions).
3. Carefully lay the blade server on a flat, static-protective surface.
4. Open the blade server cover (see “[Opening the Blade Server Cover](#)” on [page 17](#) for instructions).
5. Remove the bezel assembly (see “[Installing the Blade Server Bezel Assembly](#)” on [page 33](#) for instructions).
6. Locate the microprocessor socket on the system board.

7. Remove the two screws that secure the heat-sink filler and then remove the filler from the microprocessor socket.

Install the microprocessor:

Caution: Do not touch the pins in the microprocessor socket. Touching these pins might result in permanent damage to the system board.

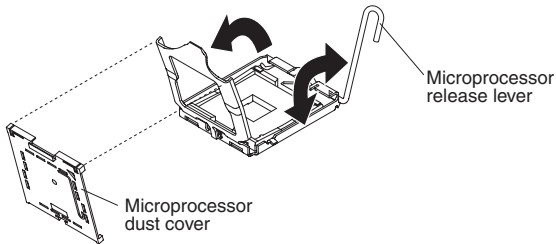

- a. Remove the protective cover from the microprocessor retainer, if one is present.

Caution: Do not use any tools or sharp objects to lift the locking lever on the microprocessor socket. Doing so might result in permanent damage to the system board.

- b. Rotate the locking lever on the microprocessor socket from its closed and locked position until it stops in the fully open position (approximately a 135° angle), as shown.
- c. Rotate the microprocessor retainer on the microprocessor socket from its closed position until it stops in the fully open position (approximately a 135° angle), as shown.
- d. Touch the static-protective package that contains the new microprocessor to any *unpainted* metal surface on the blade server or any *unpainted* metal surface on any other grounded rack component in the rack you are installing the microprocessor in for at least 2 seconds; then, remove the microprocessor from the package.
- e. Remove the cover from the bottom of the microprocessor.

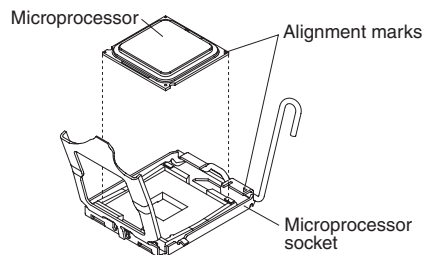

8. Center the microprocessor over the microprocessor socket. Align the triangle on the corner of the microprocessor with the triangle on the corner of the socket and carefully place the microprocessor into the socket.

Caution:

- Do not press the microprocessor into the socket.
 - Make sure that the microprocessor is oriented and aligned correctly in the socket before you try to close the microprocessor retainer.
- f. Carefully close the microprocessor retainer.
 - g. Rotate the locking lever on the microprocessor socket to the closed and locked position. Make sure that the lever is secured in the locked position by the tab on the microprocessor socket.
9. Install a heat sink on the microprocessor.

Caution:

- Do not set down the heat sink after you remove the plastic cover.
- Do not touch the thermal grease on the bottom of the heat sink. Touching the thermal grease will contaminate it. If the thermal grease on the microprocessor or heat sink becomes contaminated, contact your service technician.

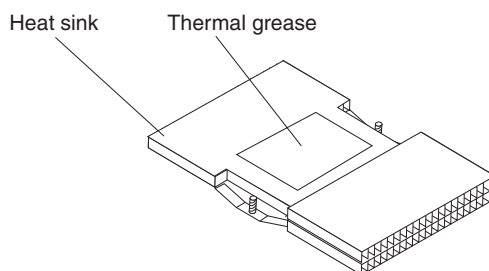

- a. Remove the plastic protective cover from the bottom of the heat sink.
 - b. Make sure that the thermal material is still on the bottom of the heat sink; then, align and place the heat sink on top of the microprocessor in the retention bracket, thermal material side down. Press firmly on the heat sink.
 - c. Align the two screws on the heat sink with the holes on the heat-sink retention module.
 - d. Press firmly on the captive screws and tighten them with a screwdriver, alternating between screws until they are tight. If possible, each screw should be rotated two full rotations at a time. Repeat until the screws are tight. Do not overtighten the screws by using excessive force. If you are using a torque wrench, tighten the screws to 8.5 to 13 Newton-meters (Nm) (6.3 to 9.6 foot-pounds).
10. If you have other options to install or remove, do so now; otherwise, go to [“Completing the Installation” on page 32.](#)

Installing an I/O-expansion Card

If I/O-expansion is supported by the SBCE unit in which the blade server is installed, you can add an I/O-expansion card to the blade server. An I/O expansion card provides additional connections for communicating on a network.

The blade server supports various types of I/O expansion cards. See <http://support.intel.com/support/> for a list of available I/O expansion cards and their form-factor types.

Make sure that the SBCE unit and the I/O modules to which the I/O expansion card is mapped support the network-interface type of the I/O expansion card. For example, if you add an Ethernet expansion card to a blade server installed in a SBCE unit, the I/O-modules in I/O-module bays 3 and 4 on the SBCE unit must both be compatible with the expansion card. All other expansion cards that are installed on other blade servers in the SBCE unit must also be compatible with these I/O-modules. In this example, you could then install two Ethernet switch modules, two pass-thru modules, or one Ethernet switch module and one pass-thru module. Because pass-thru modules are compatible with a variety of I/O-expansion cards, installing two pass-thru modules would enable the use of several different types of compatible I/O-expansion cards on blade servers within the same SBCE unit.

The following sections describe how to install an I/O-expansion card in the blade server. The illustrations show installation of the I/O-expansion cards in the system board: installing the cards in an expansion unit is similar.

Installing a Small-form-factor Expansion Card

The following illustration shows how to install a small-form-factor expansion card.

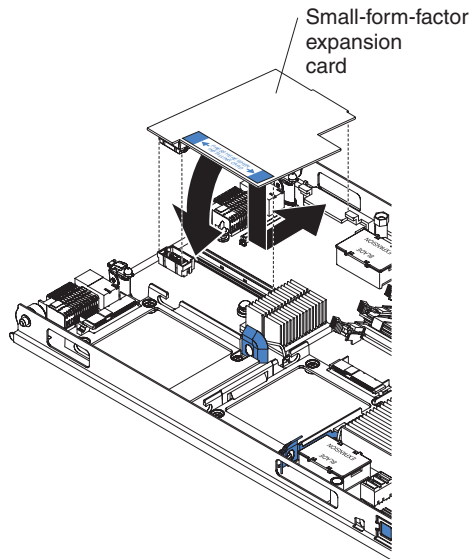

To install a small-form-factor expansion card, complete the following steps:

1. Read the safety information beginning on page [vii](#) and “[Installation Guidelines](#)” on [page 15](#).
2. Shut down the operating system, turn off the blade server, and remove the blade server from the SBCE unit (see “[Removing the Blade Server from the Intel® Blade Server Chassis SBCE](#)” on [page 16](#) for instructions).
3. Carefully lay the blade server on a flat, static-protective surface.
4. Open the cover (see “[Opening the Blade Server Cover](#)” on [page 17](#) for instructions).
5. If a Memory and I/O Expansion Blade is installed and you are installing the expansion card on the system board, remove the expansion blade (see “[Removing an Expansion Unit](#)” on [page 18](#)).
6. Touch the static-protective package that contains the expansion card to any *unpainted* metal surface on the SBCE unit or any *unpainted* metal surface on any other grounded rack component; then, remove the expansion card from the package.
7. Locate the expansion-card connector and orient the expansion card.
8. Slide the notch in the narrow end of the card into the raised hook on the expansion card bracket; then, gently pivot the card into the expansion card connectors.

Note: For device-driver and configuration information needed to complete the installation of the expansion card, see the documentation that comes with the expansion card.

9. If you have other options to install or remove, do so now; otherwise, go to “[Completing the Installation](#)” on [page 32](#).

Installing a Standard-form-factor Expansion Card

If a SAS drive is connected to SAS connector 1 (J137), you must remove it and the SAS drive tray before you can install a standard-form-factor expansion card and expansion card bracket on the system board (see [“Removing a SAS Hard Disk Drive” on page 21](#)). You cannot have both a drive that is connected to SAS connector 1 and a standard-form-factor expansion card installed in the system board of the blade server. If you are removing the SAS disk drive, backup any information on it that you want to keep to another storage device.

If the SAS hard disk drive that is installed in SAS connector 1 is part of a RAID array, delete the SAS RAID array before removing the drive. When you delete the RAID array, the array configuration information is removed, but no data is deleted.

The following illustration shows how to install a standard-form-factor expansion card.

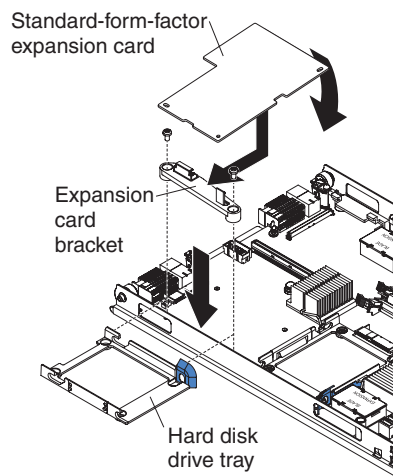

To install a standard-form-factor expansion card, complete the following steps:

1. Read the safety information beginning on page [vii](#) and [“Installation Guidelines” on page 15](#).
2. Shut down the operating system, turn off the blade server, and remove the blade server from the SBCE unit (see [“Removing the Blade Server from the Intel® Blade Server Chassis SBCE” on page 16](#) for instructions).
3. Carefully lay the blade server on a flat, static-protective surface.
4. Open the cover (see [“Opening the Blade Server Cover” on page 17](#) for instructions).
5. If a Memory and I/O Expansion Blade is installed and you are installing the expansion card on the system board, remove the expansion blade (see [“Removing an Expansion Unit” on page 18](#)).
6. If you are installing the expansion card in the system board and a drive is connected to SAS connector 1, remove the drive and tray (see [“Removing a SAS Hard Disk Drive” on page 21](#) for instructions), and save the screws that secure the tray to the system board. Store the screws in a safe place.

7. Touch the static-protective package that contains the expansion card to any *unpainted* metal surface on the SBCE unit or any *unpainted* metal surface on any other grounded rack component; then, remove the expansion card from the package.
8. Install the expansion card bracket, if it is not already installed. Secure the bracket to the system board with the screws from the option kit or from the removed drive tray.
9. Locate the expansion-card connector and orient the expansion card.
10. Slide the notch in the narrow end of the card into the raised hook on the expansion card bracket; then, gently pivot the wide end of the card into the expansion-card connectors.

Note: For device-driver and configuration information to complete the installation of the expansion card, see the documentation that comes with the expansion card.

11. If you have other options to install or remove, do so now; otherwise, go to [“Completing the Installation” on page 32](#).

Installing an Expansion Unit

Note: If an Intel® Blade Storage Expansion Module for the Intel® Server Compute Blade SBXD132 is installed on a blade server with a Memory and I/O Expansion Blade, installation of standard-form-factor or small-form-factor expansion cards in the Intel® Blade Storage Expansion Module is not supported.

The following illustration shows how to install an expansion unit on a blade server.

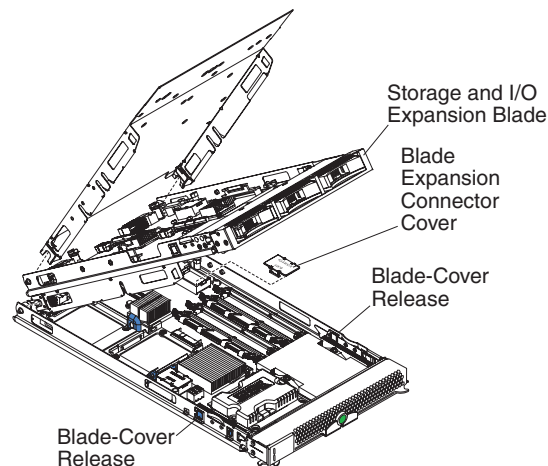

AF000642

To install an expansion unit, complete the following steps:

1. Read the safety information that begins on page [vii](#) and [“Installation Guidelines” on page 15](#).
2. If you removed the blade bezel assembly, replace it now (see [“Installing the Blade Server Bezel Assembly” on page 33](#) for instructions).

3. Remove the protective covers from the blade expansion connectors, if they are present.

Note: For some expansion units, you only need to remove the cover closest to the rear of the blade server.

4. If you are installing a Memory and I/O Expansion Blade on the blade server, remove the power jumper from power connector J164. Store the power jumper in a safe place.
5. Touch the static-protective package that contains the expansion unit to any *unpainted* metal surface on the SBCE unit or any *unpainted* metal surface on any other grounded rack component; then, remove the expansion unit from the package.
6. Install the expansion unit:
 - a. Orient the expansion unit as shown in the illustration.
 - b. Lower the expansion unit so that the slots at the rear slide down onto the cover pins at the rear of the blade server.
 - c. Close the expansion unit (see the documentation for the expansion unit for information and instructions):
 - If the expansion unit has an extraction device, pivot the expansion unit closed; then, use the extraction device to fully seat the expansion unit on the system board. These extraction devices can be of several types, including thumb screws or levers.
 - If the expansion unit has no extraction device, pivot the expansion unit closed; then, press the expansion unit firmly into place until the blade-cover releases click.

The connectors on the expansion unit automatically align with and connect to the connectors on the system board.

7. If you have other expansion units to install, do so now; otherwise, go to [“Completing the Installation” on page 32](#).

Completing the Installation

To complete the installation, complete the following tasks. Instructions for each task are in the following sections.

1. Reinstall the blade server bezel assembly, if you removed it (see [“Installing the Blade Server Bezel Assembly” on page 33](#) for information on installing the bezel assembly).
2. Reinstall the Memory and I/O Expansion Blade, if you removed it to install other options (see [“Installing an Expansion Unit” on page 31](#) for information on installing the Memory and I/O Expansion Blade).
3. Close the blade server cover, unless you installed an optional expansion unit that has its own cover (see [“Closing the Blade Server Cover” on page 34](#)).

Caution: *Hazardous energy is present when the blade server is connected to the power source. Always replace the blade cover before installing the blade server.*

4. Reinstall the blade server into the SBCE unit (see “[Installing the Blade Server in an Intel® Blade Server Chassis SBCE](#)” on page 35).
5. Turn on the blade server (see “[Turning on the Blade Server](#)” on page 9).
6. For certain options, run the blade server Configuration/Setup Utility program (see [Chapter 6, “Configuring the Blade Server”](#)).

Note: *If you have just connected the power cords of the SBCE unit to electrical outlets, you must wait until the power-on LED on the blade server flashes slowly before you press the power-control button.*

Installing the Blade Server Bezel Assembly

The following illustration shows how to install the bezel assembly.

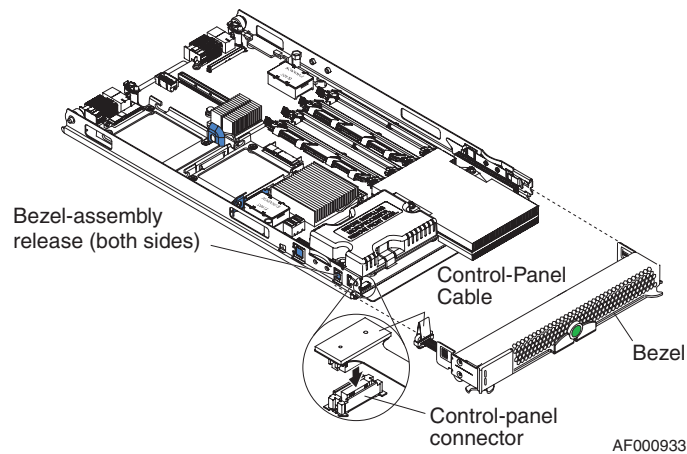

To install the blade server bezel assembly, complete the following steps:

1. Read the safety information beginning on page [vii](#) and “[Installation Guidelines](#)” on [page 15](#).
2. Connect the control-panel cable to the control-panel connector on the system board.
3. Carefully slide the bezel assembly onto the blade server until it clicks into place.

Closing the Blade Server Cover

Attention: You cannot insert the blade server into the SBCE unit until the cover is installed and closed or an expansion unit is installed. Do not attempt to override this protection.

The following illustration shows how to close the blade server cover.

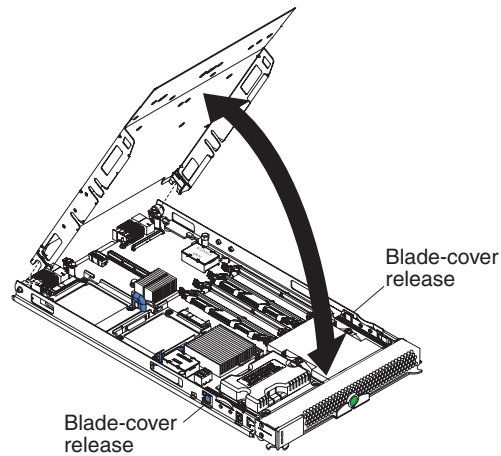

AF000641

To close the blade server cover, complete the following steps:

1. Read the safety information beginning on page [vii](#) and “[Installation Guidelines](#)” on [page 15](#).
2. If you removed the blade bezel assembly, replace it now (see “[Installing the Blade Server Bezel Assembly](#)” on [page 33](#) for instructions).
3. If a Memory and I/O Expansion Blade is *not* installed on the blade server, make sure that the power jumper is installed in power connector J164.
4. Lower the cover so that the slots at the rear slide down onto the pins at the rear of the blade server, as shown in the illustration. Before closing the cover, make sure that all components are installed and seated correctly and that you have not left loose tools or parts inside the blade server.
5. Pivot the cover to the closed position, as shown in the illustration, until it clicks into place.

Installing the Blade Server in an Intel® Blade Server Chassis SBCE

The following illustration shows how to install a blade server into a chassis. The appearance of your SBCE unit might be different, see the documentation for your SBCE unit for additional information.

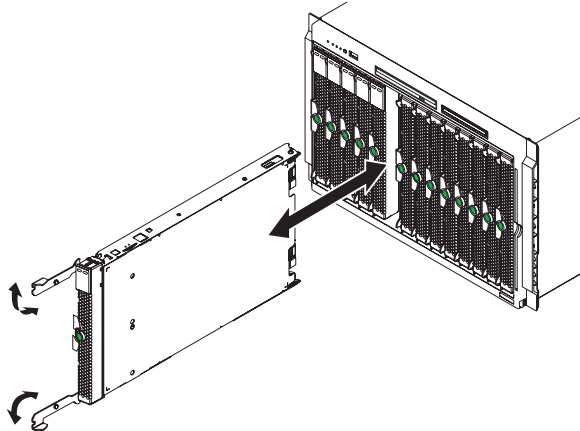

AF000944

To install a blade server in a SBCE unit, complete the following steps.

Caution: *Hazardous energy is present when the blade server is connected to the power source. Always replace the blade cover before installing the blade server.*

1. Read the safety information beginning on page [vii](#) and “[Installation Guidelines](#)” on page [15](#) through “[Handling Static-sensitive Devices](#)” on page [16](#).
2. If you have not done so already, install any options that you want, such as SAS drives or memory, in the blade server.
3. Select the bay for the blade server; at least one blade bay is required.

Notes:

- *When any blade server or option is in blade bays 7 through 14, power modules must be present in all four power-module bays. For additional information, see the [Installation and User’s Guide](#) that comes with the SBCE unit.*
 - *To help ensure proper cooling, performance, and system reliability, make sure that each blade bay on the front of the SBCE unit contains a blade server, expansion unit, or blade filler. Do not operate a SBCE unit for more than 1 minute without a blade server, expansion unit, or blade filler in each blade bay.*
4. Make sure that the release handles on the blade server are in the open position (perpendicular to the blade server).
 5. Slide the blade server into the blade bay until it stops.
 6. Push the release handles on the front of the blade server to the closed position.
 7. Turn on the blade server (see “[Turning on the Blade Server](#)” on page [9](#) for instructions).

8. Make sure that the power-on LED on the blade server control panel is lit continuously, indicating that the blade server is receiving power and is turned on.
9. If you have other blade servers to install, do so now.

If you reinstall a blade server that you removed, you must install it in the same blade bay from which you removed it. Some blade server configuration information and update options are established according to bay number. Reinstalling a blade server into a different blade bay from the one from which it was removed could have unintended consequences, and you might have to reconfigure the blade server.

If this is the initial installation for the blade server in the SBCE unit, you must configure the blade server through the Configuration/Setup Utility program and install the blade server operating system. See [“Updating the Blade Server Configuration” on page 36](#) and [Chapter 7, “Installing the Operating System”](#) for details.

Updating the Blade Server Configuration

When the blade server starts for the first time after you add or remove an internal option, you might receive a message that the configuration has changed. The Configuration/Setup Utility program automatically starts so that you can save the new configuration settings. See [“Using the Configuration/Setup Utility program” on page 57](#) for more information about the Configuration/Setup Utility program.

Some options have device drivers that you must install. See the documentation that comes with each option for information about installing device drivers.

The blade server comes with at least one microprocessor. If more than one microprocessor is installed, the blade server can operate as a symmetric multiprocessing (SMP) server. You might have to upgrade the operating system to support SMP. See [Chapter 7, “Installing the Operating System”](#) and your operating-system documentation for additional information.

Input/output Connectors and Devices

The input/output connectors that are available to the blade server are supplied by the SBCE unit. See the documentation that comes with the SBCE unit for information about the input/output connectors.

The blade server has two selection buttons on the control panel: the media tray select button and the keyboard/video/mouse select button. See [“Understanding the Control Panel and LEDs” on page 10](#) for information about these buttons and their functions.

The Ethernet controllers on the blade server communicate with the network through the Ethernet-compatible I/O modules on the SBCE unit. Network signals to and from the blade server or any expansion cards are automatically routed to a same-network-interface I/O module through circuitry in the SBCE unit.

4 Memory and I/O Expansion for the Intel® Server Compute Blade SBXD132

Memory and I/O expansion for the Intel® Server Compute Blade SBXD132 is provided by installation of an optional expansion unit, which can support up to four additional dual-inline memory (DIMM) connectors. The memory and I/O expansion unit can also support installation of standard-form-factor and small-form-factor cards, as well as a storage expansion unit, such as the Intel® Blade Storage Expansion Module (see “[Intel® Blade Storage Expansion Module for the Intel® Server Compute Blade SBXD132](#)” on page 39 for additional details).

Note: *If an Intel® Blade Storage Expansion Module is installed on the Memory and I/O Expansion Unit then installation of standard-form-factor or small-form-factor expansion cards are not supported in the Intel® Blade Storage Expansion Module.*

The following illustration shows the memory and I/O expansion unit and some of the available optional components.

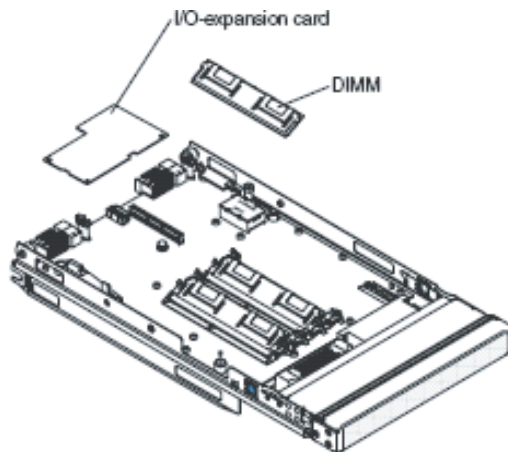

5 Intel® Blade Storage Expansion Module for the Intel® Server Compute Blade SBXD132

The Intel® Blade Storage Expansion Module for the Intel® Server Compute Blade SBXD132 is a redundant array of independent disks (RAID) storage device which can be installed on a blade server that supports Serial Attached SCSI (SAS) hard disk drives (see the *Tested Hardware and Operating System List* at <http://support.intel.com/support/> to see if your blade server supports this expansion unit). The expansion unit has an intelligent RAID controller and cache memory that can support RAID level-0, level-1, and level-5 (depending on the model). It supports RAID configurations that use up to three hot-swap SAS hard disk drives in the expansion unit and up to two hard disk drives that are installed in the host blade server.

The expansion unit also supports up to two I/O-expansion cards (standard-form-factor, and small-form-factor) to provide additional network connections and has a blade expansion connector that allows another expansion unit to be installed.

Notes:

- *The illustrations in this document might differ slightly from your hardware.*

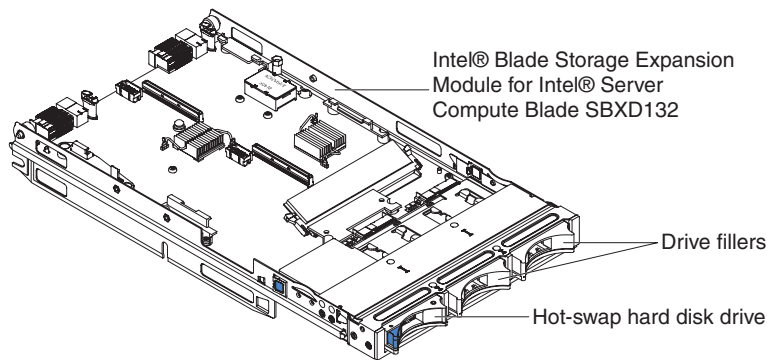

AF000935

Installation Guidelines

Before you install the expansion unit on a blade server, read the following information:

- Read the safety information that begins on page vii and the guidelines in “[Handling Static-sensitive Devices](#)” on page 40. This information will help you work safely.
- Observe good housekeeping in the area where you are working. Place removed covers and other parts in a safe place.

- Back up all important data before you make changes to disk drives.
- Before you remove a blade server from the SBCE unit, you must shut down the operating system and turn off the blade server. You do not have to shut down the SBCE unit itself.
- Blue on a component indicates touch points, where you can grip the component to remove it from or install it in the blade server, or open or close a latch.

System Reliability Considerations

To help ensure proper cooling and system reliability, make sure that:

- Each of the blade bays on the front of the SBCE unit contains either a blade server, expansion unit or filler.
- A removed blade server or filler is replaced within 1 minute of removal.
- Each of the hard disk drive bays in the expansion unit contains either a hot-swap SAS hard disk drive or a filler.

Handling Static-sensitive Devices

Note: *Static electricity can damage electronic devices and your blade server. To avoid damage, keep static-sensitive devices in their static-protective packages until you are ready to install them.*

To reduce the possibility of damage from electrostatic discharge, observe the following precautions:

- Limit your movement. Movement can cause static electricity to build up around you.
- Handle the device carefully, holding it by its edges or its frame.
- Do not touch solder joints, pins, or exposed printed circuitry.
- Do not leave the device where others can handle and damage it.
- While the device is still in its static-protective package, touch it to an *unpainted* metal part of the SBCE unit or any *unpainted* metal surface on any other grounded rack component in the rack in which you are installing the device for at least 2 seconds. This drains static electricity from the package and from your body.
- Remove the device from its package and install it directly on the blade server without setting the device down. If it is necessary to set down the device, put it back into its static-protective package. Do not place the device on your SBCE unit or on a metal surface.
- Take additional care when handling devices during cold weather. Heating reduces indoor humidity and increases static electricity.

Notices and Statements used in this Document

The following notices and statements are used in the documentation:

- **Note:** These notices provide important tips, guidance, or advice.
- **Important:** These notices provide information or advice that might help you avoid inconvenient or problem situations.
- **Attention:** These notices indicate possible damage to programs, devices, or data. An attention notice is placed just before the instruction or situation in which damage could occur.
- **Caution:** These statements indicate situations that can be potentially hazardous to you. A caution statement is placed just before the description of a potentially hazardous procedure step or situation.
- **Danger:** These statements indicate situations that can be potentially lethal or extremely hazardous to you. A danger statement is placed just before the description of a potentially lethal or extremely hazardous procedure step or situation.

Installing the Expansion Unit

Notes:

1. *The expansion unit can be installed only on a blade server that supports SAS hard disk drives (see the Tested Hardware and Operating System List at <http://support.intel.com/support/> to see if your blade server supports this expansion unit).*
2. *After you install the expansion unit on a host blade server, the combined unit will occupy one additional blade bay in the SBCE unit than the host blade server alone.*

The following illustrations show how to install the expansion unit.

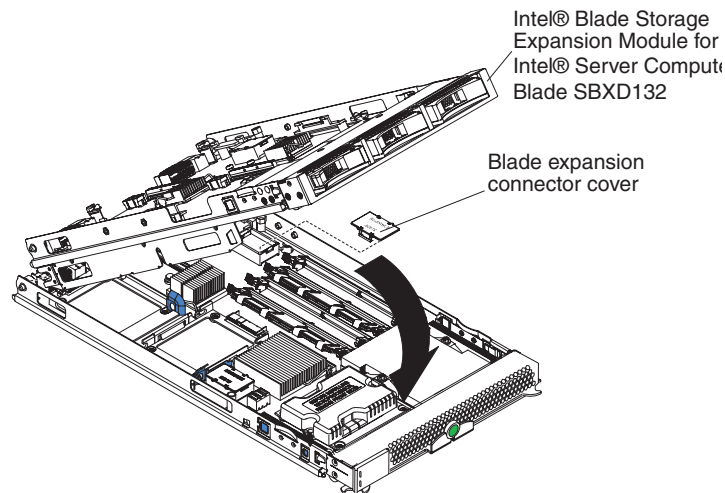

AF000936

Complete the following steps to install the expansion unit:

1. Read the Safety information beginning on page [vii](#) and “[Installation Guidelines](#)” on [page 39](#).
2. If the host blade server is installed in a SBCE unit, shut down the operating system and turn off the blade server; then, remove the blade server from the SBCE unit (see the documentation that comes with the blade server for more information).
3. Carefully lay the blade server on a flat, static-protective surface.
4. Open the blade server cover and lift it off of the blade server (see the documentation that comes with the blade server for more information).
5. Locate the blade expansion connector near the rear of the host blade server and remove the cover from the connector.
6. Touch the static-protective package that contains the expansion unit to any *unpainted* metal surface on the SBCE unit or any *unpainted* metal surface on another grounded rack component; then, remove the expansion unit from the package.
7. Orient the expansion unit over the blade server.
8. Lower the expansion unit so that the slots at the rear slide down onto the pins at the rear of the blade server.
9. Pivot the expansion unit closed and press it firmly into place until the cover-release latches click. The connector on the expansion unit automatically aligns with and connects to the blade expansion connector on the blade server.
10. Install a ServeRAID™ SAS controller in the expansion unit (see “[Installing a ServeRAID SAS Controller](#)” on [page 45](#)).
11. If you have I/O-expansion cards to install in the expansion unit, do so now (see “[Installing an I/O-expansion Card](#)” on [page 47](#)); otherwise, go to “[Completing the Installation](#)” on [page 51](#).

Installing the Expansion Unit Cover

The following illustration shows how to install the expansion unit cover.

Note: Once the expansion unit is installed on the host blade server, the blade server cover is used as the expansion unit cover.

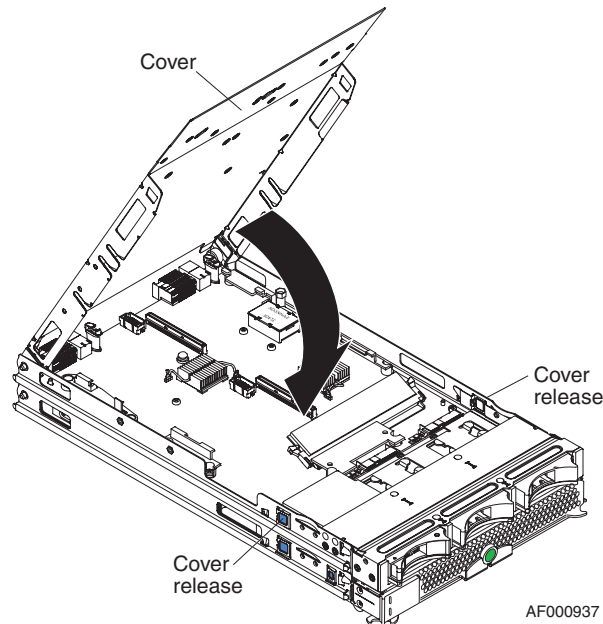

Complete the following steps to install the expansion unit cover:

1. Read the Safety information beginning on page [vii](#) and “[Installation Guidelines](#)” on [page 39](#).
2. Orient the cover over the expansion unit.
3. Lower the cover so that the slots at the rear slide down onto the pins at the rear of the expansion unit.
4. Pivot the cover closed and press it firmly into place until the cover-release latches click.

Caution: Hazardous energy is present when the blade is connected to the power source. Always replace the blade cover before installing the blade.

Removing the Expansion Unit Cover

The following illustration shows how to remove the expansion unit cover.

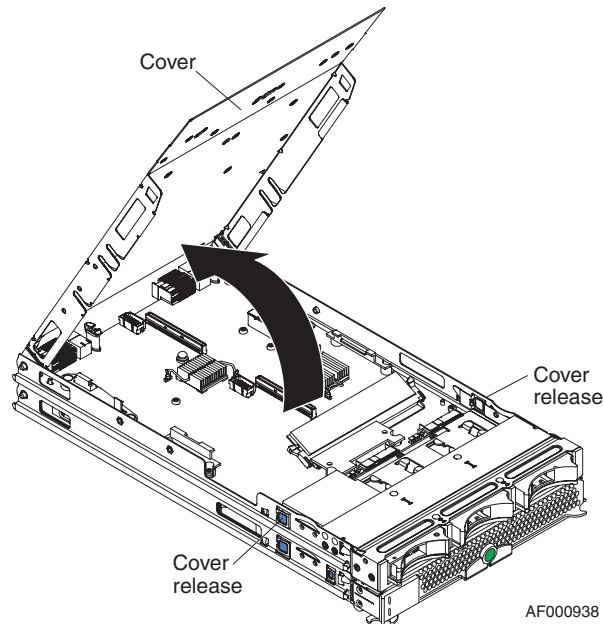

Complete the following steps to remove the expansion unit cover:

1. Read the Safety information beginning on page [vii](#) and “[Installation Guidelines](#)” on [page 39](#).
2. If the host blade server and expansion unit are installed in a SBCE unit, shut down the operating system and turn off the blade server; then, remove the combined blade server and expansion unit from the SBCE unit (see the documentation that comes with the blade server for more information).
3. Carefully lay the combined unit down on a flat, static-protective surface, with the cover side up.
4. Press the cover release on each side of the expansion unit and lift the cover open.
5. Lift the cover from the expansion unit and store it for future use.

Caution: *Hazardous energy is present when the blade server is connected to the power source. Always replace the blade cover before installing the blade server.*

Installing a ServeRAID SAS Controller

The Intel® Blade Storage Expansion Module SBESAS comes with a ServeRAID SAS Controller that supports RAID level-0 and level-1. An optional ServeRAID SAS Controller AB256BSE (256-MB cache memory and battery backup for the Intel® Blade Storage Expansion Module SBESAS) is also available that supports RAID level-0, level-1, and level-5. You must install one of these SAS controllers before you can create and use the RAID.

Complete the following steps to install a ServeRAID SAS Controller:

1. Read the Safety information beginning on page [vii](#) and “[Installation Guidelines](#)” on [page 39](#).
2. If the host blade server and expansion unit are installed in a SBCE unit, shut down the operating system and turn off the blade server; then, remove the combined blade server and expansion unit from the SBCE unit (see the documentation that comes with the blade server for more information).
3. Carefully lay the combined unit down on a flat, static-protective surface, with the cover side up.
4. Remove the cover from the expansion unit (see “[Removing the Expansion Unit Cover](#)” on [page 44](#)).

To install a ServeRAID SAS Controller, complete the following steps.

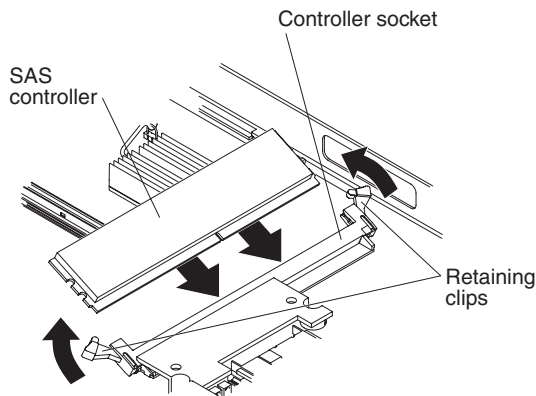

1. Touch the static-protective package that contains the ServeRAID SAS Controller to any *unpainted* metal surface on the SBCE unit or any *unpainted* metal surface on any other grounded rack component; then, remove the SAS controller from the package.
2. Make sure that both of the controller socket retaining clips are in the fully open position.
3. Orient the SAS controller so that the keys align correctly with the controller socket.

Caution: To avoid breaking the retaining clips or damaging the controller socket, open and close the clips gently.

4. Insert the SAS controller by pressing it along the guides into the connector socket. Make sure that the retaining clips snap into the closed position.

To install a ServeRAID SAS Controller AB256BSE, complete the following steps.

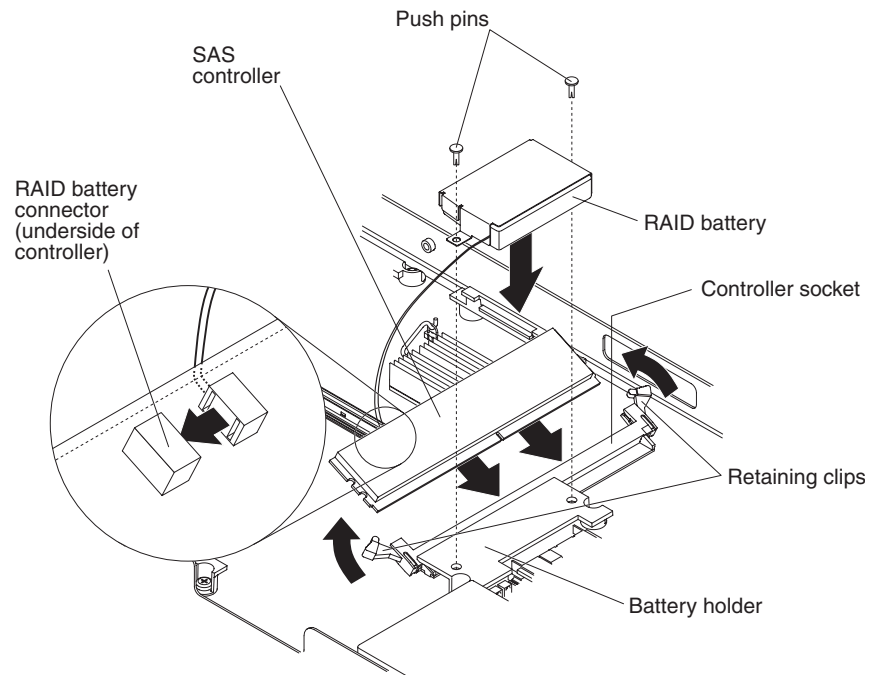

1. Touch the static-protective package that contains the RAID battery to any *unpainted* metal surface on the SBCE unit or any *unpainted* metal surface on any other grounded rack component; then, remove the RAID battery from the package.
2. Place the RAID battery into position on the battery holder.
3. Insert the two push pins until they lock the battery into place in the battery holder.
4. Touch the static-protective package that contains the ServeRAID SAS Controller AB256BSE to any *unpainted* metal surface on the SBCE unit or any *unpainted* metal surface on any other grounded rack component; then, remove the SAS controller from the package.
5. Connect the RAID battery cable to the connector on the underside of the controller.

Note: Route the RAID battery cable over the top of the SAS controller to make sure that it does not interfere with the installation.

6. Make sure that both of the controller socket retaining clips are in the fully open position.
7. Orient the SAS controller so that the keys align correctly with the controller socket.

Caution: To avoid breaking the retaining clips or damaging the controller socket, open and close the clips gently.

8. Insert the SAS controller by pressing it along the guides into the connector socket. Make sure that the retaining clips snap into the closed position.
9. If you have I/O-expansion cards to install in the expansion unit, do so now (see [“Installing an I/O-expansion Card” on page 47](#)); otherwise, go to [“Completing the Installation” on page 51](#).

Installing an I/O-expansion Card

You can install up to two I/O-expansion cards in the expansion unit to provide additional connections for communicating on a network. The following illustration shows the locations of the connectors and the different form factors of the supported I/O-expansion cards in the expansion unit.

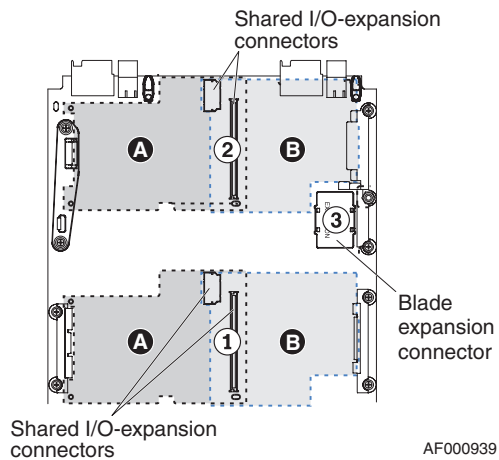

Before installing an I/O-expansion card, consider the following information:

- The expansion unit supports two different form factors of I/O-expansion cards: standard form factor (A) and small form factor (B).
- Either a standard-form-factor or a small-form-factor card can be installed in each pair of the shared connectors, (1 and 2).
- The network-interface type of the I/O-expansion card must be supported by the corresponding I/O modules in the SBCE unit.
 - Connector 1 provides a connection to SBCE unit I/O bays 1 and 2.
 - Connector 2 provides a connection to SBCE unit I/O bays 3 and 4.

To install an I/O-expansion card, complete the following steps:

1. Read the Safety information beginning on page [vii](#) and [“Installation Guidelines” on page 39](#).
2. If the host blade server and expansion unit are installed in a SBCE unit, complete the following steps:

- a. Shut down the operating system and turn off the blade server; then, remove the combined blade server and expansion unit from the SBCE unit (see the documentation that comes with the blade server for more information).
 - b. Carefully lay the combined unit down on a flat, static-protective surface, with the cover side up.
 - c. Remove the cover from the expansion unit (see [“Removing the Expansion Unit Cover” on page 44](#)).
3. Touch the static-protective package that contains the expansion card to any *unpainted* metal surface on the SBCE unit or any *unpainted* metal surface on any other grounded rack component; then, remove the expansion card from the package.
 4. To install a small-form-factor expansion card, complete the following steps.

Note: *The following illustration shows how to install a small-form-factor expansion card in the rear connectors of the expansion unit; installing a card in the connectors closest to the front of the expansion unit is similar.*

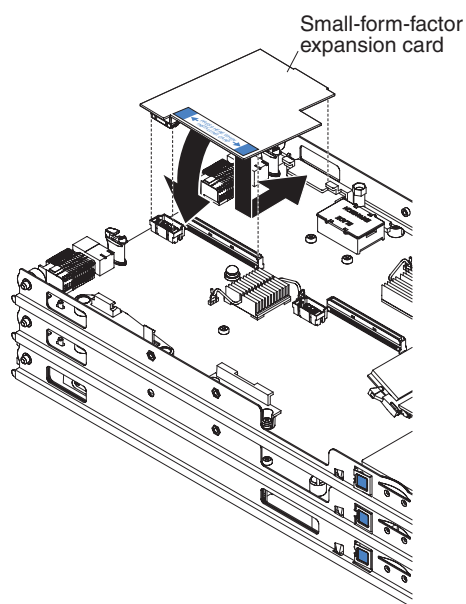

- a. Locate the expansion-card connectors and orient the expansion card above them.
- b. Slide the notch in the narrow end of the card into the raised hook on the expansion-card bracket; then, gently pivot the card into the expansion-card connectors.

5. To install a standard-form-factor expansion card, complete the following steps.

Note: *The following illustration shows how to install a standard-form-factor expansion card in the rear connectors of the expansion unit; installing a card in the connectors closest to the front of the expansion unit is similar.*

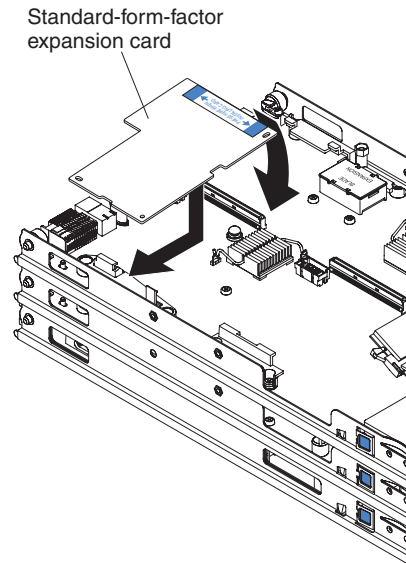

- a. Locate the expansion-card connectors and orient the expansion card above them.
- b. Slide the notch in the narrow end of the card into the raised hook on the expansion-card bracket; then, gently pivot the wide end of the card into the expansion-card connectors.

Installing a Hot-swap SAS Hard Disk Drive

After you have installed the expansion unit on the blade server, you can install up to three hot-swap SAS hard disk drives in the expansion unit.

Note: You do not have to turn off the blade server to install or remove hot-swap hard disk drives from the expansion unit.

The following illustration shows how to install a hot-swap SAS hard disk drive.

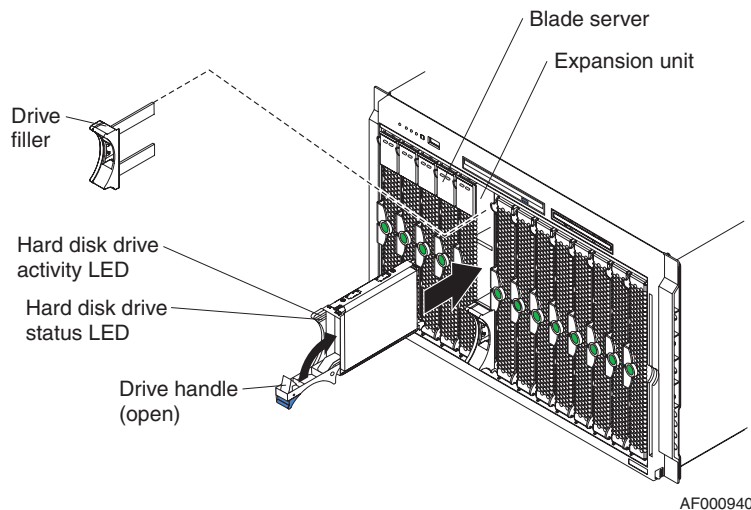

Complete the following steps to install a hot-swap SAS hard disk drive in the expansion unit.

Caution: To maintain proper system cooling, do not operate the SBCE unit for more than 1 minute without either a hard disk drive or a drive filler installed in each hard disk drive bay.

1. Read the Safety information beginning on page [vii](#) and “Installation Guidelines” on [page 39](#).
2. Select the hot-swap bay in which you want to install the hard disk drive.
3. Firmly grasp the drive filler that is in the bay and pull it out of the expansion unit.
4. If you are installing a new hard disk drive, touch the static-protective package that contains the drive to any *unpainted* metal surface on the SBCE unit or any *unpainted* metal surface on any other grounded rack component; then, remove the drive from the package.
5. Make sure that the drive handle is in the open position (perpendicular to the drive).
6. Align the hard disk drive with the guide rails in the bay.
7. Gently push the hard disk drive into the bay until the drive stops.
8. Push the drive handle to the closed (locked) position.

Caution: *Make sure that a drive filler is installed in any disk drive bay that does not contain a hard disk drive.*

9. Make sure that the host blade server is turned on; then, check the hard disk drive LEDs to make sure that the drive is operating correctly.
 - If the green hard disk drive activity LED is flashing, the drive is being accessed.
 - If the amber hard disk drive status LED is lit continuously, that drive is faulty and must be replaced.

Completing the Installation

To complete the installation, complete the following tasks:

1. Install the cover on the expansion unit (see [“Installing the Expansion Unit Cover” on page 43](#)).
2. Insert the combined blade server and expansion unit into the SBCE unit.

Note: *Make sure that the SBCE unit has the required number of power modules present to supply power to the blade bay in which the expansion unit is installed. For additional information, see the documentation that comes with the SBCE unit.*

3. If you have hot-swap hard disk drives to install in the expansion unit, do so now (see [“Installing a Hot-swap SAS Hard Disk Drive” on page 50](#)). Make sure that a drive filler is installed in any disk drive bay that does not contain a hard disk drive.
4. Turn on the blade server.
5. If you have just installed a ServeRAID SAS controller, complete the following steps:
 - a. If you want to include the host blade server hard disk drives in the expansion unit RAID, use the configuration utility in the blade server to enable this option (see the documentation that comes with the blade server for more information).
 - b. Use a RAID configuration program to create and manage the RAID (see [“Configuring the Expansion Unit RAID Array” on page 52](#) for more information).

Configuring the Expansion Unit RAID Array

After installing a new ServeRAID SAS controller in the expansion unit, you must configure the RAID array before it can be used. Basic RAID configuration can be performed using either the Adaptec RAID Configuration Utility or the ServeRAID Manager program. The ServeRAID Manager program also provides additional configuration features.

Using the Adaptec RAID Configuration Utility Program

Use the Adaptec RAID Configuration Utility program to perform the following tasks:

- Create a RAID array
- View the RAID configuration and associated devices

Starting the Adaptec RAID Configuration Utility Program

To start the Adaptec RAID Configuration Utility program, complete the following steps:

1. Turn on the server.
2. When the prompt <<< Press <CTRL><A> for Adaptec RAID Configuration Utility! >>> appears, press Ctrl+A.
3. To select a choice from the menu, use the arrow keys to highlight it and press Enter.

Adaptec RAID Configuration Utility Menu Choices

The following choices are on the Adaptec RAID Configuration Utility menu:

- **Array Configuration Utility**
Select this choice to create, manage, or delete arrays, or to initialize drives.
- **Serial Select Utility**
Select this choice to configure the controller interface definitions or to configure the physical transfer and SAS address of the selected drive.
- **Disk Utilities**
Select this choice to format a disk or verify the disk media. Select a device from the list and read the instructions on the screen carefully before making a selection.

Creating a RAID Array

To create a RAID array, complete the following steps:

1. Start the Adaptec RAID Configuration Utility program (see [“Starting the Adaptec RAID Configuration Utility Program”](#) on page 52).
2. Select **Array Configuration Utility**.
3. From the Main menu, select **Create Array**.

Note: *Hard disk drives in an array can have different capacities, but the RAID controller treats them as if they all have the capacity of the smallest hard disk drive.*

4. From the list of available drives, select the drives that you want to include in the array and press Enter.
5. From the list of RAID levels available, select the one you want to use.
6. Follow the instructions on the screen to complete the configuration; then, select **Done** to exit.
7. Restart the server.

Viewing the Array Configuration

To view information about the RAID array, complete the following steps:

1. Start the Adaptec RAID Configuration Utility program (see [“Starting the Adaptec RAID Configuration Utility Program”](#) on page 52).
2. Select **Array Configuration Utility**.
3. From the Main menu, select **Manage Arrays**.
4. Select an array and press Enter.
5. To exit from the program, press Esc.

Using the ServeRAID Manager Program

The ServeRAID Support CD contains the ServeRAID Manager program, which you can use to configure the hard disk drives for use with the ServeRAID SAS controller in the expansion unit. For details about using this programs, see the documentation that comes on the IBM ServeRAID Support CD.

Light Path Diagnostics*

Light path diagnostics is a system of LEDs on the system board of the expansion unit. When an error occurs, these LEDs can be lit to help identify the source of the error.

To view the light path LEDs, remove the blade server and expansion unit from the SBCE unit; then, press and hold the light path diagnostics switch for a maximum of 25 seconds. The light path diagnostics LED will be lit to indicate that there is enough power present to light the error LEDs, and the LED for the failing component also will be lit.

The following illustration shows the locations of the light path LEDs on the expansion unit system board.

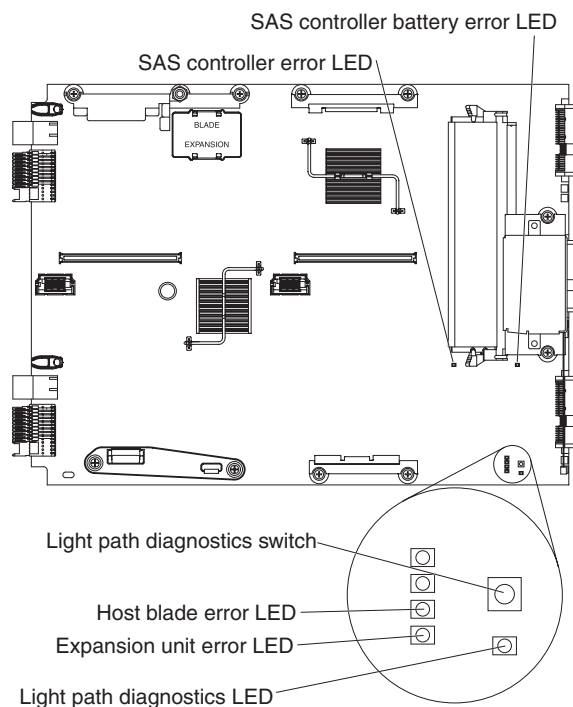

The following table describes the LEDs on the expansion unit system board and suggested actions to correct the detected problems. Follow the suggested actions in the order in which they are listed in the Action column until the problem is solved.

Lit light path diagnostics LED	Description	Action
Expansion unit error (amber)	A system board error has occurred in the expansion unit.	Check for error LEDs that are lit on the expansion unit system board. Reseat the following components: <ol style="list-style-type: none"> 1. SAS controller 2. SAS controller battery. 3. Expansion unit. 4. Replace the expansion unit.
Host blade error (amber)	A system board error has occurred on the host blade server.	Remove the expansion unit from the blade server and check the blade server for errors (see the documentation that comes with the blade server for more information).
Light path diagnostics (green)	The light path LEDs on the expansion unit system board have power.	Check for error LEDs that are lit on the expansion unit system board.
SAS controller battery error (amber)	The SAS controller battery has failed.	<ol style="list-style-type: none"> 1. Reseat the SAS controller battery cable. 2. Replace the SAS controller battery.

Lit light path diagnostics LED	Description	Action
SAS controller error (amber)	An error has occurred in the SAS controller.	<ol style="list-style-type: none"> 1. Reseat the SAS controller. 2. Replace the SAS controller. 3. Replace the expansion unit.

6 Configuring the Blade Server

This chapter describes the configuration requirements for the blade server. Before you continue, you should make sure that the blade server has the latest version of firmware code. For additional information, see [“Firmware Updates” on page 61](#).

The following configuration programs come with the blade server:

- **Configuration/Setup Utility program**
The Configuration/Setup Utility program is part of the basic input/output system (BIOS) code in the blade server. Use it to change system settings, such as interrupt requests (IRQ), date and time, and passwords. See [“Using the Configuration/Setup Utility program” on page 57](#) for more information.
- **LSI Logic Configuration Utility program**
The LSI Logic Configuration Utility program is part of the BIOS code in the blade server. Use it to set the device scan order and to set the SAS controller IDs. See [“Using the LSI Logic Configuration Utility Program” on page 63](#) for more information.
- **Preboot Execution Environment (PXE) boot agent utility program**
The PXE boot agent utility program is part of the BIOS code in the blade server. Use it to select the boot protocol and other boot options and to select a power-management option. For information about using this utility program, see [“Using the PXE Boot Agent Utility Program” on page 61](#).

Using the Configuration/Setup Utility program

To start the Configuration/Setup Utility program, complete the following steps:

1. Turn on the blade server (see [“Turning on the Blade Server” on page 9](#)).
2. Immediately give the blade server control of the SBCE unit shared keyboard, video, and mouse ports.
 - If you are managing the blade server using the system console, press the KVM select button on the blade server (see [“Understanding the Control Panel and LEDs” on page 10](#) for information).
 - If you are managing the blade server from a remote location, see the *Intel® Blade Server Management Module SBCECMM Installation and User’s Guide*, *Intel® Server Blade Chassis Enterprise Management Module CBCECMM2: Installation and User’s Guide*, *Intel® Blade Server Chassis SBCE: Management Module Command-Line Interface Reference Guide*, or *Intel® Blade Server Chassis SBCE: Serial Over LAN (SOL) Setup Guide* for information and instructions.
3. When the Configuration/Setup utility message appears, press **F1**.
4. Follow the instructions on the screen.

Configuration/Setup Utility Menu Choices

The following choices are on the Configuration/Setup Utility main menu. Depending on the version of the BIOS code in the blade server, some menu choices might differ slightly from these descriptions.

- **System Summary**

Select this choice to display configuration information, including the type, speed, and cache sizes of the microprocessors and the amount of installed memory. When you make configuration changes through other options in the Configuration/Setup Utility program, the changes are reflected in the system summary; you cannot change settings directly in the system summary.

- **Processor Summary**

Select this choice to view information about the microprocessors installed in the blade server.

- **USB Device Summary**

Select this choice to view information about the USB devices installed in the blade server.

- **System Information**

Select this choice to display information about the blade server. When you make configuration changes through other options in the Configuration/Setup Utility program, some of those changes are reflected in the system information; you cannot change settings directly in the system information.

- **Product Data**

Select this choice to view the machine type and model of the blade server, the serial number, and the revision level or issue date of the BIOS and diagnostics code stored in electrically erasable programmable ROM (EEPROM).

- **Devices and I/O Ports**

Select this choice to view or change assignments for devices and input/output (I/O) ports.

You can also enable or disable the integrated SAS and Ethernet controllers, all standard ports (such as serial), and the I/O-expansion card. **Enable** is the default setting for all controllers. If you disable a device, it cannot be configured, and the operating system will not be able to detect it (this is equivalent to disconnecting the device). If you disable the Ethernet controller, the blade server will have no Ethernet capability.

With an optional Intel® Blade Storage Expansion Module for the Intel® Server Compute Blade SBXD132, you can control all of the SAS hard disk drives in the host blade server. Set **BSE3 Controls All Blade SAS HDD** to **Enable** to control all of the hard disk drives in the host blade server.

- **Remote Console Redirection**

Select this choice to enable Serial over LAN (SOL) and to set remote console communication parameters.

- **Video**

Select this choice to view information about the integrated video controller.

— **System MAC Addresses**

Select this choice to set and view the MAC addresses for the Ethernet controllers on the blade server.

• **Date and Time**

Select this choice to set the system date and time, in 24-hour format (*hour:minute:second*).

• **System Security**

Select this choice to set a power-on password. See “Using Passwords” on page 61 for more information about passwords.

• **Start Options**

Select this choice to view or change the start options. Changes in the start options take effect when you start the blade server.

— **Startup Sequence Options**

Select this choice to view the startup device sequence that is set for the blade server.

***Note:** To set the startup sequence, which is the order in which the blade server checks devices to find a boot record, you must use the management-module Web interface.*

You can set keyboard operating characteristics, such as whether the blade server starts with the keyboard number lock on or off. You can enable the blade server to run without a diskette drive or keyboard.

You can enable or disable the PXE option for either of the integrated Gigabit Ethernet controllers. The default setting is **Planar Ethernet 1**, which enables the PXE option for the first Ethernet controller on the system board.

If you enable the boot fail count, the BIOS default settings will be restored after three consecutive failures to find a boot record.

You can enable a virus-detection test that checks for changes in the boot record when the blade server starts.

This choice is on the full Configuration/Setup menu only.

• **Advanced Setup**

Select this choice to change settings for advanced hardware features.

***Important:** The blade server might malfunction if these options are incorrectly configured. Follow the instructions on the screen carefully.*

— **Memory Settings**

Select this choice to manually enable a pair of memory connectors.

If a memory error is detected during POST or memory configuration, the blade server automatically disables the failing memory pair of memory connectors and continues operating with reduced memory. After the problem is corrected, you must enable the memory connectors. Use the arrow keys to highlight the pair of memory connectors that you want to enable, and use the arrow keys to select **Enable**.

To maintain optimum system operation in the event of a memory failure, you can set the **Memory Configuration** for memory **Mirroring** or **Sparing**. Memory mirroring stores duplicate data on two DIMMs to prevent data loss if a DIMM fails. Memory sparing removes the failed memory from the system configuration and activates a Hot Spare Memory pair of DIMMs to replace the failed memory pair of DIMMs. Before you can enable the memory mirroring or sparing, at least two pairs of DIMMs must be installed in the blade server that adhere to the special requirements described in [“Installing Memory Modules” on page 22](#). Set the **Memory Configuration** to **Flat** to disable memory mirroring and sparing.

***Note:** Memory mirroring is available only when an optional Intel® Blade Server Memory and I/O Expansion Blade is installed on the blade server.*

— **CPU Options**

Select this choice to disable the microprocessor cache or to set the microprocessor cache to use the write-back or the write-through method. Write-back caching generally provides better system performance.

You can also select this choice to enable or disable hyper-threading and adjust microprocessor performance settings. If enabled, hyper-threading will only be active if it is supported by your operating system.

— **PCI Bus Control**

Select this choice to view and set interrupts for PCI devices and to configure the master-latency-timer value for the blade server.

— **Baseboard Management Controller (BMC) Settings**

Select this choice to enable or disable the **Reboot on System NMI** option on the menu. If you enable this option, the blade server will automatically restart 60 seconds after the service processor issues a nonmaskable interrupt (NMI) to the blade server. You can also select this choice to enable or disable and set the time-outs for the POST and OS loader watchdog timers and view BMC version information.

-- **BMC Network Configuration**

Select this choice to set the network addresses of the BMC.

-- **BMC System Event Log**

Select this choice to view and clear BMC event log entries.

• **Save Settings**

Select this choice to save the changes you have made in the settings.

• **Restore Settings**

Select this choice to cancel the changes you have made in the settings and restore the previous settings.

• **Load Default Settings**

Select this choice to cancel the changes you have made in the settings and restore the factory settings.

• **Exit Setup**

Select this choice to exit from the Configuration/Setup Utility program. If you have not saved the changes you have made in the settings, you are asked whether you want to save the changes or exit without saving them.

Using Passwords

From the **System Security** choice, you can set, change, and delete a power-on password.

If you set a power-on password, you must type the power-on password to complete the system startup and to have access to the full Configuration/Setup Utility menu.

You can use any combination of up to seven characters (A–Z, a–z, and 0–9) for the password. Keep a record of your password in a secure place.

If you forget the power-on password, you can regain access to the blade server in by removing the blade server battery and then reinstalling it, or by using the power-on password override switch (see the *Intel® Server Compute Blade SBXD132 Hardware Maintenance and Troubleshooting Guide* on the Resource CD for instructions).

Using the PXE Boot Agent Utility Program

Use the Preboot Execution Environment (PXE) boot agent utility program to select the boot protocol and other boot options and to select a power-management option.

Note: The blade server does not support Remote Program Load (RPL) selection for the boot protocol option.

To start the PXE boot agent utility program, complete the following steps:

1. Turn on the server.
2. When the `Broadcom NetXtreme Boot Agent vX.X.X` prompt appears, press `Ctrl+S`. You have 2 seconds (by default) to press `Ctrl+S` after the prompt appears.

If the PXE setup prompt is not displayed, use the Configuration/Setup Utility program to set the **Enable Ethernet PXE/DHCP** option.

3. Use the arrow keys or press `Enter` to select a choice from the menu.
4. Follow the instructions on the screen to change the settings of the selected items; then, press `Enter`.

Firmware Updates

Intel periodically makes BIOS, service processor (BMC), and diagnostic firmware updates available for the blade server. Before you install the blade server in a SBCE unit, go to <http://support.intel.com/support/> to download the latest firmware for the blade server. Install the updates, using the instructions that are included with the downloaded files.

Important: To avoid problems and to maintain proper system performance, always make sure that the BIOS, service processor (BMC), and diagnostic firmware levels are consistent for all blade servers within the SBCE unit.

Configuring the Gigabit Ethernet Controllers

Two Ethernet controllers are integrated on the blade server system board. Each controller provides a 1000-Mbps full-duplex interface for connecting to one of the Ethernet-compatible I/O-modules in I/O-module bays 1 and 2, which enables simultaneous transmission and reception of data on the Ethernet local area network (LAN). Each Ethernet controller on the system board is routed to a different I/O-module in I/O-module bay 1 or bay 2. The routing from an Ethernet controller to I/O-module bay will vary based on blade server type and the operating system that is installed. See “Blade Server Ethernet Controller Enumeration” on page 62 for information about how to determine the routing from an Ethernet controller to an I/O-module bay for the blade server.

Note: Other types of blade servers, such as the Intel® Server Compute Blade SBX82, that are installed in the same SBCE unit as the Intel® Server Compute Blade SBXD132 might have different Ethernet controller routing. See the documentation that comes with the other blade servers for information.

You do not have to set any jumpers or configure the controllers for the blade server operating system. However, you must install a device driver to enable the blade server operating system to address the Ethernet controllers. For device drivers and information about configuring the Ethernet controllers, see the *Broadcom NetXtreme Gigabit Ethernet Software* CD that comes with the blade server. For updated information about configuring the controllers, see <http://support.intel.com/support/>.

The Ethernet controllers in your blade server support failover, which provides automatic redundancy for the Ethernet controllers. Without failover, you can have only one Ethernet controller from each server attached to each virtual LAN or subnet. With failover, you can configure more than one Ethernet controller from each server to attach to the same virtual LAN or subnet. Either one of the integrated Ethernet controllers can be configured as the primary Ethernet controller. If you have configured the controllers for failover and the primary link fails, the secondary controller takes over. When the primary link is restored, the Ethernet traffic switches back to the primary Ethernet controller. See the operating-system device-driver documentation for information about configuring for failover.

Important: To support failover on the blade server Ethernet controllers, the Ethernet switch modules in the SBCE unit must have identical configurations.

Blade Server Ethernet Controller Enumeration

The enumeration of the Ethernet controllers in a blade server is operating-system dependent. You can verify the Ethernet controller designations that a blade server uses through the operating-system settings.

The routing of an Ethernet controller to a particular I/O-module bay depends on the type of blade server. You can verify which Ethernet controller is routed to which I/O-module bay by using the following test:

1. Install only one Ethernet switch module or pass-thru module in I/O-module bay 1.
2. Make sure that the ports on the switch module or pass-thru module are enabled (click **I/O-module Tasks** “**Management**” **Advanced Management** in the management module Web-based user interface).
3. Enable only one of the Ethernet controllers on the blade server. Note the designation that the blade server operating system has for the controller.
4. Ping an external computer on the network connected to the switch module or pass-thru module. If you can ping the external computer, the Ethernet controller that you enabled is associated with the switch module or pass-thru module in I/O-module bay 1. The other Ethernet controller in the blade server is associated with the switch module or pass-thru module in I/O-module bay 2.

If you have installed an I/O-expansion card in the blade server, communications from the expansion card are routed to I/O-module bays 3 and 4. You can verify which controller on the card is routed to which I/O-module bay by performing the same test and using a controller on the expansion card and a compatible switch module or pass-thru module in I/O-module bay 3 or 4.

Configuring a RAID Array

Configuring a SAS RAID array applies to a blade server in which two SAS hard disk drives are installed.

Two SAS hard disk drives in the blade server can be used to implement and manage RAID level-0 (striping) or RAID level-1 (mirror) arrays in operating systems that are listed on <http://support.intel.com/support/>. For the blade server, you must configure the SAS RAID using the LSI Configuration Utility program.

If an optional Intel® Blade Storage Expansion Module for the Intel® Server Compute Blade SBXD132 is installed, you can use it to control all of the SAS hard disk drives installed in the blade server. You enable this feature using the Configuration/Setup Utility program (see Devices and I/O Ports on page 58 for information and instructions).

Using the LSI Logic Configuration Utility Program

You can use the LSI Logic Configuration Utility program to:

- Set the SAS device scan order
- Set the SAS ID for the controller
- Manage the SAS RAID configuration

Starting the LSI Logic Configuration Utility program

To start the LSI Logic Configuration Utility program, complete the following steps:

1. Turn on the blade server (make sure that the blade server is the owner of the keyboard, video, and mouse) and watch the monitor screen.
2. When the <<<Press Ctrl-C to start LSI Logic Configuration Utility>>> prompt appears, press Ctrl-C.
3. Use the arrow keys to select the controller from the list of adapters; then, press Enter.
4. Follow the instructions on the screen to change the settings of the selected items; then, press Enter. If you select **SAS Topology** or **Advanced Adapter Properties**, additional screens are displayed.

7 Installing the Operating System

Important:

- 1. The operating system in the blade server must provide USB support for the blade server to recognize and use the keyboard, mouse, and removable-media drives. The Intel® Blade Server Chassis SBCE uses USB for internal communication with these devices.*
- 2. Some operating systems enable you to select the type of mouse that is being used. If you are offered this choice, select USB instead of PS/2. Although the mouse might be a PS/2-style device, communication with the mouse is through an internal USB bus in the SBCE unit; therefore, the operating system in the blade server must recognize the mouse as a USB device.*

8 Solving Problems

This chapter provides basic information about the diagnostic tools that are available to help you solve some common problems that might occur while you are setting up the blade server.

If you install the blade server in the SBCE unit and the blade server does not start, perform the following actions:

- Make sure that the SBCE unit is correctly connected to a power source.
- Reseat the blade server in the SBCE unit (see [“Installing the Blade Server in an Intel® Blade Server Chassis SBCE” on page 35](#)).
- If the power-on LED is flashing slowly, turn on the blade server (see [“Turning on the Blade Server” on page 9](#)).
- If you have just added a new optional device or component, make sure that it is correctly installed and compatible with the blade server and its components. If the device or component is not compatible, remove it from the blade server, reinstall the blade server in the SBCE unit, and then restart the blade server.

If the blade server does not start after you have performed the preceding actions, see the *Intel® Server Compute Blade SBXD132 Hardware Maintenance and Troubleshooting Guide* on the Resource CD.

Diagnostic Tools Overview

The following tools are available to help you diagnose and solve hardware-related problems:

- **POST beep codes**

The power-on self-test beep codes can indicate the detection of a problem.

 - One beep indicates successful completion of POST
 - Repeating long beeps indicate a memory error. Make sure that all DIMMs are correctly installed.
 - Additional beep codes are listed under “Diagnostics” in the *Hardware Maintenance and Troubleshooting Guide* for your blade server type.
- **POST error codes**

The POST error codes indicate the detection of a problem. See the *Hardware Maintenance and Troubleshooting Guide* for more information.
- **Troubleshooting tables**

Use the troubleshooting tables to find solutions to problems that have identifiable symptoms. These tables are in the *Hardware Maintenance and Troubleshooting Guide* for your blade server.

- **Diagnostic programs and error messages**

Real Time Diagnostics tests the major components of the Intel® blade server system, including the management modules, I/O-modules, removable media drives, and the blade servers, while the operating system is running. See the *Hardware Maintenance and Troubleshooting Guide* for more information.

Note: If you are unable to find the system error logs in the blade-server firmware code, view the system event log in the chassis management module.

- **Light path diagnostics**

Use light path diagnostics LEDs on the system board to identify system errors. If the system-error LED on the system LED panel on the front or rear of the SBCE unit is lit, one or more error LEDs on the SBCE unit components also might be lit. These LEDs help identify the cause of the problem. Blade server error LEDs are described in the *Hardware Maintenance and Troubleshooting Guide* for your blade server.

A Warranty

Limited Warranty for Intel® Chassis Subassembly Products

Intel warrants that the Products (defined herein as the Intel® chassis subassembly and all of its various components and software delivered with or as part of the Products) to be delivered hereunder, if properly used and installed, will be free from defects in material and workmanship and will substantially conform to Intel's publicly available specifications for a period of three (3) years after the date the Product was purchased from an Intel authorized distributor. Software of any kind delivered with or as part of products is expressly provided “as is” unless specifically provided for otherwise in any software license accompanying the software.

If any Product furnished by Intel which is the subject of this Limited Warranty fails during the warranty period for reasons covered by this Limited Warranty, Intel, at its option, will:

- REPAIR the Product by means of hardware and/or software; OR
- REPLACE the Product with another Product; OR
- REFUND the then-current value of the Product if Intel is unable to repair or replace the Product.

If such Product is defective, transportation charges for the return of Product to buyer within the USA will be paid by Intel. For all other locations, the warranty excludes all costs of shipping, customs clearance, and other related charges. Intel will have a reasonable time to make repairs or to replace Product or to refund the then-current value of the Product.

In no event will Intel be liable for any other costs associated with the replacement or repair of Product, including labor, installation or other costs incurred by buyer and in particular, any costs relating to the removal or replacement of any product soldered or otherwise permanently affixed to any printed circuit board.

This Limited Warranty, and any implied warranties that may exist under state law, apply only to the original purchaser of the Product.

Extent of Limited Warranty

Intel does not warrant that Products to be delivered hereunder, whether delivered stand-alone or integrated with other Products, including without limitation semiconductor components, will be free from design defects or errors known as “errata.” Current characterized errata are available upon request.

This Limited Warranty does not cover damages due to external causes, including accident, problems with electrical power, usage not in accordance with product instructions, misuse, neglect, alteration, repair, improper installation, or improper testing.

Warranty Limitations and Exclusions

These warranties replace all other warranties, expressed or implied including, but not limited to, the implied warranties of merchantability and fitness for a particular purpose. Intel makes no expressed warranties beyond those stated here. Intel disclaims all other warranties, expressed or implied including, without limitation, implied warranties of merchantability and fitness for a particular purpose. Some jurisdictions do not allow the exclusion of implied warranties, so this limitation may not apply.

All expressed and implied warranties are limited in duration to the limited warranty period. No warranties apply after that period. Some jurisdictions do not allow limitations on how long an implied warranty lasts, so this limitation may not apply to you.

Limitations of Liability

Intel's responsibility under this, or any other warranty, implied or expressed, is limited to repair, replacement, or refund, as set forth above. These remedies are the sole and exclusive remedies for any breach of warranty. Intel is not responsible for direct, special, incidental, or consequential damages resulting from any breach of warranty under another legal theory including, but not limited to, lost profits, downtime, goodwill, damage to or replacement of equipment and property, and any costs of recovering, reprogramming, or reproducing any program or data stored in or used with a system containing this product. Some jurisdictions do not allow the exclusion or limitation of incidental or consequential damages, so the above limitations or exclusions may not apply to you.

This limited warranty gives you specific legal rights, and you may also have other rights that vary from jurisdiction to jurisdiction.

Any and all disputes arising under or related to this Limited Warranty shall be adjudicated in the following forums and governed by the following laws: for the United States of America, Canada, North America, and South America, the forum shall be Santa Clara, California, USA, and the applicable law shall be that of the State of California, USA; for the Asia Pacific region, the forum shall be Singapore and the applicable law shall be that of Singapore; for Europe and the rest of the world, the forum shall be London and the applicable law shall be that of the United Kingdom.

In the event of any conflict between the English language version and any other translated version(s) of this Limited Warranty, the English language version shall control.

How to Obtain Warranty Service

To obtain warranty service for this Product, you may contact Intel or your authorized distributor.

- North America and Latin America To obtain warranty repair for the product, please go to the following Web site to obtain instructions: <http://support.intel.com/support/motherboards/draform.htm>
- In Europe and in Asia Contact your original authorized distributor for warranty service.

Any replacement Product is warranted under this written warranty and is subject to the same limitations and exclusions for the remainder of the original warranty period.

Telephone Support

If you cannot find the information you need on Intel's World Wide Web site (<http://www.intel.com/>), call your local distributor or an Intel Customer Support representative. See “[Getting Help](#)” for telephone numbers.

Returning a Defective Product

Before returning any product, call your authorized dealer/distribution authority.

B Regulatory and Compliance Information

Product Regulatory Compliance

Warning: *To ensure regulatory compliance, you must adhere to the assembly instructions in this guide to ensure and maintain compliance with existing product certifications and approvals. Use only the described, regulated components specified in this guide. Use of other products/components will void the UL listing and other regulatory approvals of the product and will most likely result in noncompliance with product regulations in the region(s) in which the product is sold.*

This is an FCC Class A device. Integration of it into a Class B chassis does not result in a Class B device.

Product Safety Compliance

This blade server product, when correctly integrated per this guide, complies with the following safety and electromagnetic compatibility (EMC) regulations.

Intended Application

This product was evaluated as Information Technology Equipment (ITE), which may be installed in offices, schools, computer rooms, and similar commercial type locations. The suitability of this product for other product categories and environments (such as: medical, industrial, telecommunications, NEBS, residential, alarm systems, test equipment, etc.), other than an ITE application, may require further evaluation.

Product Safety Compliance

The server chassis complies with the following product safety requirements:

- UL60950-1 - CSA 60950-1 (USA / Canada)
- EN60950-1 (Europe)
- IEC60950-1 (International)
- CB Certificate & Report, IEC6095-1 (report to include all country national deviations)
- GOST R 50377-92 - License (Russia)
- CE - Low Voltage Directive 73/23/EEE (Europe)
- CNS 14336 BSMI Certification (Taiwan)

Product EMC Compliance - Class A Compliance

This blade server has been tested and verified to comply with the following electromagnetic compatibility (EMC) regulations when installed in a compatible Intel® host system. For information on compatible host system(s) contact your local Intel representative.

- FCC /ICES-003 - Emissions (USA/Canada) Verification
- CISPR 22 - Emissions (International)
- EN55022 - Emissions (Europe)
- EN55024 - Immunity (Europe)
- EN61000-3-2 - Harmonics (Europe)
- EN61000-3-3 - Voltage Flicker (Europe)
- CE - EMC Directive 89/336/EEC (Europe)
- VCCI Emissions (Japan)
- AS/NZS 3548 Emissions (Australia / New Zealand)
- BSMI CNS13438 Emissions (Taiwan)
- GOST R 29216-91 Emissions (Russia)
- GOST R 50628-95 Immunity (Russia)
- RRL MIC Notice No. 1997-41 (EMC) & 1997-42 (EMI) (Korea)

Certifications / Registrations / Declarations

- UL/cUL Listing (US/Canada)
- CE Declaration of Conformity (Europe)
- FCC/ICES-003 Class A Verification (USA/Canada)
- VCCI Certification (Japan)
- C-Tick Declaration of Conformity (Australia/New Zealand)
- BSMI Certification (Taiwan)
- GOST R Certification / License (Russia)
- RRL Certification (Korea)

Product Regulatory Compliance Markings

This Intel® product bears the following regulatory marks.

Table 1. Product Regulatory Compliance Markings

Regulatory Compliance	Region	Marking
cULus Listing Marks	USA/Canada	
CE Mark	Europe	
FCC Marking (Class A)	USA	This device complies with Part 15 of the FCC Rules. Operation of this device is subject to the following two conditions: (1) This device may not cause harmful interference, and (2) This device must accept any interference received, including interference that may cause undesired operation. Manufactured by Intel Corporation
EMC Marking (Class A)	Canada	CANADA ICES-003 CLASS A CANADA NMB-003 CLASSE A
VCCI Marking (Class A)	Japan	この装置は、クラス A 情報技術装置です。この装置を家庭環境で使用すると電波妨害を引き起こすことがあります。この場合には使用者が適切な対策を講ずるよう要求されることがあります。VCCI-A
BSMI Certification Number & Class A Warning	Taiwan	 <div style="border: 1px solid black; padding: 5px; width: fit-content;">警告使用者： 這是甲類的資訊產品，在居住的環境中使用時，可能會造成射頻干擾，在這種情況下，使用者會被要求採取某些適當的對策</div>
GOST R Marking	Russia	
RRL MIC Mark	Korea	 인증번호: CPU See the regulatory information document for additional information.

Electromagnetic Compatibility Notices

FCC Verification Statement (USA)

This device complies with Part 15 of the FCC Rules. Operation is subject to the following two conditions: (1) this device may not cause harmful interference, and (2) this device must accept any interference received, including interference that may cause undesired operation.

For questions related to the EMC performance of this product, contact:

Intel Corporation
5200 N.E. Elam Young Parkway
Hillsboro, OR 97124-6497
1-800-628-8686

This equipment has been tested and found to comply with the limits for a Class A digital device, pursuant to Part 15 of the FCC Rules. These limits are designed to provide reasonable protection against harmful interference in a residential installation. This equipment generates, uses, and can radiate radio frequency energy and, if not installed and used in accordance with the instructions, may cause harmful interference to radio communications. However, there is no guarantee that interference will not occur in a particular installation. If this equipment does cause harmful interference to radio or television reception, which can be determined by turning the equipment off and on, the user is encouraged to try to correct the interference by one or more of the following measures:

- Reorient or relocate the receiving antenna.
- Increase the separation between the equipment and the receiver.
- Connect the equipment to an outlet on a circuit other than the one to which the receiver is connected.
- Consult the dealer or an experienced radio/TV technician for help.

Any changes or modifications not expressly approved by the grantee of this device could void the user's authority to operate the equipment. The customer is responsible for ensuring compliance of the modified product.

Only peripherals (computer input/output devices, terminals, printers, etc.) that comply with FCC Class A or B limits may be attached to this computer product. Operation with noncompliant peripherals is likely to result in interference to radio and TV reception.

All cables used to connect to peripherals must be shielded and grounded. Operation with cables, connected to peripherals, that are not shielded and grounded may result in interference to radio and TV reception.

Industry Canada (ICES-003)

Cet appareil numérique respecte les limites bruits radioélectriques applicables aux appareils numériques de Classe A prescrites dans la norme sur le matériel brouilleur: "Appareils Numériques", NMB-003 édictée par le Ministre Canadien des Communications.

English translation of the notice above:

This digital apparatus does not exceed the Class A limits for radio noise emissions from digital apparatus set out in the interference-causing equipment standard entitled: "Digital Apparatus," ICES-003 of the Canadian Department of Communications.

Europe (CE Declaration of Conformity)

This product has been tested in accordance to, and complies with the Low Voltage Directive (73/23/EEC) and EMC Directive (89/336/EEC). The product has been marked with the CE Mark to illustrate its compliance.

VCCI (Japan)

<p>この装置は、情報処理装置等電波障害自主規制協議会（VCCI）の基準に基づくクラスA情報技術装置です。この装置を家庭環境で使用すると電波妨害を引き起こすことがあります。この場合には使用者が適切な対策を講ずるよう要求されることがあります。</p>	
--	--

English translation of the preceding notice:

This is a Class A product based on the standard of the Voluntary Control Council for Interference (VCCI) from Information Technology Equipment. If this is used near a radio or television receiver in a domestic environment, it may cause radio interference. Install and use the equipment according to the instruction manual.

BSMI (Taiwan)

<p>警告使用者： 這是甲類的資訊產品，在居住的環境中使用時，可能會造成射頻干擾，在這種情況下，使用者會被要求採取某些適當的對策</p>

The BSMI Certification Marking and EMC warning is located on the outside rear area of the product.

Korean Compliance (RRL)

Following is the RRL certification information for Korea.

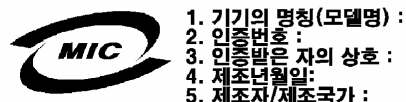

English translation of the notice above:

1. Type of Equipment (Model Name): On License and Product
2. Certification No.: On RRL certificate. Obtain certificate from local Intel representative
3. Name of Certification Recipient: Intel Corporation
4. Date of Manufacturer: Refer to date code on product
5. Manufacturer/Nation: Intel Corporation/Refer to country of origin marked on product

Restriction of Hazardous Substances (RoHS) Compliance

Intel has a system in place to restrict the use of banned substances in accordance with the European Directive 2002/95/EC. Compliance is based on declaration that materials banned in the RoHS Directive are either (1) below all applicable substance threshold limits or (2) an approved/pending RoHS exemption applies.

Note: *RoHS implementing details are not fully defined and may change.*

Threshold limits and banned substances are noted as follows:

- Quantity limit of 0.1% by mass (1000 PPM) for:
 - Lead
 - Mercury
 - Hexavalent chromium
 - Polybrominated biphenyls diphenyl ethers (PBDE, PBB)
- Quantity limit of 0.01% by mass (100 PPM) for:
 - Cadmium

End of Life / Product Recycling

Product recycling and end-of-life take back systems and requirements vary from country to country. Contact the retailer or distributor of this product for information on product recycling and / or take back.

C Getting Help

World Wide Web

<http://support.intel.com/support/motherboards/server/blade.htm>

Telephone

All calls are billed US \$25.00 per incident, levied in local currency at the applicable credit card exchange rate plus applicable taxes. (Intel reserves the right to change the pricing for telephone support at any time without notice).

For an updated support contact list, see <http://www.intel.com/support/9089.htm/>

U.S. and Canada

1-800-404-2284

Europe

Belgium 02 714 3182
Denmark ... 38 487077
Finland 9 693 79297
France..... 01 41 918529
Germany ... 069 9509 6099
Holland..... 020 487 4562
Italy..... 02 696 33276
Norway 23 1620 50
Spain..... 91 377 8166
Sweden..... 08 445 1251
UK..... 870 6072439

In Asia-Pacific region

Australia.... 1800 649931

Cambodia.. 63 2 636 9797 (via Philippines)

China 800 820 1100 (toll-free)
..... 8 621 33104691 (not toll-free)

Hong Kong 852 2 844 4456

India..... 0006517 2 68303634 (manual toll-free. You need an IDD-equipped telephone)

Indonesia ... 803 65 7249

Korea 822 767 2595

Malaysia 1 800 80 1390

Myanmar... 63 2 636 9796 (via Philippines)

New Zealand 0800 444 365

Pakistan.... 632 63684 15 (IDD via Philippines)

Philippines 1 800 1 651 0117

Singapore .. 65 6213-1311

Taiwan 2 2545-1640

Thailand 1 800 631 0003

Vietnam 632 6368416 (IDD via Philippines)

Japan

Domestic.... 0120 868686

Outside country 81 298 47 0800

Latin America

Argentina .. Contact AT&T USA at 0-800 222 1288. Once connected, dial 800 843 4481

Brazil 001-916 377 0180

Chile

Easter Island. Contact AT&T USA at 800 800 311. Once connected, dial 800 843 4481

Mainland and Juan .. Contact AT&T USA at 800 225 288. Once connected, dial 800 843 4481

Colombia... Contact AT&T USA at 01 800 911 0010. Once connected, dial 800 843 4481

Costa Rica . Contact AT&T USA at 0 800 0 114 114. Once connected, dial 800 843 4481

Ecuador

(Andimate) Contact AT&T USA at 1 999 119. Once connected, dial 800 843 4481

(Pacifictel) Contact AT&T USA at 1 800 225 528. Once connected, dial 800 843 4481

Guatemala. Contact AT&T USA at 99 99 190. Once connected, dial 800 843 4481

Mexico Contact AT&T USA at 001 800 462 628 4240. Once connected, dial 800 843 4481

Miami 1 800 621 8423

Panama..... Contact AT&T USA at 00 800 001 0109. Once connected, dial 800 843 4481

Paraguay ... 001 916 377 0114

Peru 001 916 377 0114

Uruguay..... 001 916 377 0114

Venezuela... Contact AT&T USA at 0 800 2255 288. Once connected, dial 800 843 4481

D Safety Information

English

Server Safety Information

This document applies to Intel® server boards, Intel® server chassis and installed peripherals. To reduce the risk of bodily injury, electrical shock, fire, and equipment damage, read this document and observe all warnings and precautions in this guide before installing or maintaining your Intel® server product.







In the event of a conflict between the information in this document and information provided with the product or on the website for a particular product, the product documentation takes precedence.

Your server should be integrated and serviced only by technically qualified persons.

You must adhere to the guidelines in this guide and the assembly instructions in your server manuals to ensure and maintain compliance with existing product certifications and approvals. Use only the described, regulated components specified in this guide. Use of other products / components will void the UL Listing and other regulatory approvals of the product, and may result in noncompliance with product regulations in the region(s) in which the product is sold.

Safety Warnings and Cautions

To avoid personal injury or property damage, before you begin installing the product, read, observe, and adhere to all of the following safety instructions and information. The following safety symbols may be used throughout the documentation and may be marked on the product and / or the product packaging.

CAUTION	Indicates the presence of a hazard that may cause minor personal injury or property damage if the CAUTION is ignored.
WARNING	Indicates the presence of a hazard that may result in serious personal injury if the WARNING is ignored.
	Indicates potential hazard if indicated information is ignored.
	Indicates shock hazards that result in serious injury or death if safety instructions are not followed.
	Indicates hot components or surfaces.
	Indicates do not touch fan blades, may result in injury.
	Indicates to unplug all AC power cord(s) to disconnect AC power
	Please recycle battery

Intended Application Uses

This product was evaluated as Information Technology Equipment (ITE), which may be installed in offices, schools, computer rooms, and similar commercial type locations. The suitability of this product for other product categories and environments (such as medical, industrial, residential, alarm systems, and test equipment), other than an ITE application, may require further evaluation.

Site Selection

The system is designed to operate in a typical office environment. Choose a site that is:

- Clean, dry, and free of airborne particles (other than normal room dust).
- Well-ventilated and away from sources of heat including direct sunlight and radiators.
- Away from sources of vibration or physical shock.
- Isolated from strong electromagnetic fields produced by electrical devices.
- In regions that are susceptible to electrical storms, we recommend you plug your system into a surge suppressor and disconnect telecommunication lines to your modem during an electrical storm.
- Provided with a properly grounded wall outlet.
- Provided with sufficient space to access the power supply cord(s), because they serve as the product's main power disconnect.

Equipment Handling Practices

Reduce the risk of personal injury or equipment damage:

- Conform to local occupational health and safety requirements when moving and lifting equipment.
- Use mechanical assistance or other suitable assistance when moving and lifting equipment.
- To reduce the weight for easier handling, remove any easily detachable components.

Power and Electrical Warnings

Caution: *The power button, indicated by the stand-by power marking, DOES NOT completely turn off the system AC power, 5V standby power is active whenever the system is plugged in. To remove power from system, you must unplug the AC power cord from the wall outlet. Your system may use more than one AC power cord. Make sure all AC power cords are*

unplugged. Make sure the AC power cord(s) is/are unplugged before you open the chassis, or add or remove any non hot-plug components.

Do not attempt to modify or use an AC power cord if it is not the exact type required. A separate AC cord is required for each system power supply.

Some power supplies in Intel® servers use Neutral Pole Fusing. To avoid risk of shock use caution when working with power supplies that use Neutral Pole Fusing.

The power supply in this product contains no user-serviceable parts. Do not open the power supply. Hazardous voltage, current and energy levels are present inside the power supply. Return to manufacturer for servicing.

When replacing a hot-plug power supply, unplug the power cord to the power supply being replaced before removing it from the server.

To avoid risk of electric shock, turn off the server and disconnect the power cord, telecommunications systems, networks, and modems attached to the server before opening it.

Power Cord Warnings

If an AC power cord was not provided with your product, purchase one that is approved for use in your country.

Caution: *To avoid electrical shock or fire, check the power cord(s) that will be used with the product as follows:*

- *Do not attempt to modify or use the AC power cord(s) if they are not the exact type required to fit into the grounded electrical outlets*
- *The power cord(s) must meet the following criteria:*
- *The power cord must have an electrical rating that is greater than that of the electrical current rating marked on the product.*
- *The power cord must have safety ground pin or contact that is suitable for the electrical outlet.*
- *The power supply cord(s) is/are the main disconnect device to AC power. The socket outlet(s) must be near the equipment and readily accessible for disconnection.*
- *The power supply cord(s) must be plugged into socket-outlet(s) that is /are provided with a suitable earth ground.*

System Access Warnings

Caution: *To avoid personal injury or property damage, the following safety instructions apply whenever accessing the inside of the product:*

- *Turn off all peripheral devices connected to this product.*
- *Turn off the system by pressing the power button to off.*
- *Disconnect the AC power by unplugging all AC power cords from the system or wall outlet.*

- *Disconnect all cables and telecommunication lines that are connected to the system.*
- *Retain all screws or other fasteners when removing access cover(s). Upon completion of accessing inside the product, refasten access cover with original screws or fasteners.*
- *Do not access the inside of the power supply. There are no serviceable parts in the power supply. Return to manufacturer for servicing.*
- *Power down the server and disconnect all power cords before adding or replacing any non hot-plug component.*
- *When replacing a hot-plug power supply, unplug the power cord to the power supply being replaced before removing the power supply from the server.*

Caution: *If the server has been running, any installed processor(s) and heat sink(s) may be hot. Unless you are adding or removing a hot-plug component, allow the system to cool before opening the covers. To avoid the possibility of coming into contact with hot component(s) during a hot-plug installation, be careful when removing or installing the hot-plug component(s).*

Caution: *To avoid injury do not contact moving fan blades. If your system is supplied with a guard over the fan, do not operate the system without the fan guard in place.*

Rack Mount Warnings

The equipment rack must be anchored to an unmovable support to prevent it from tipping when a server or piece of equipment is extended from it. The equipment rack must be installed according to the rack manufacturer's instructions.

Install equipment in the rack from the bottom up, with the heaviest equipment at the bottom of the rack.

Extend only one piece of equipment from the rack at a time.

You are responsible for installing a main power disconnect for the entire rack unit. This main disconnect must be readily accessible, and it must be labeled as controlling power to the entire unit, not just to the server(s).

To avoid risk of potential electric shock, a proper safety ground must be implemented for the rack and each piece of equipment installed in it.

Electrostatic Discharge (ESD)

Caution: *ESD can damage disk drives, boards, and other parts. We recommend that you perform all procedures at an ESD workstation. If one is not available, provide some ESD protection by wearing an antistatic wrist strap attached to chassis ground -- any unpainted metal surface -- on your server when handling parts.*

Always handle boards carefully. They can be extremely sensitive to ESD. Hold boards only by their edges. After removing a board from its protective wrapper or from the server, place the board component side up on a grounded, static free surface. Use a

conductive foam pad if available but not the board wrapper. Do not slide board over any surface.

Other Hazards

Battery Replacement

Caution: *There is the danger of explosion if the battery is incorrectly replaced. When replacing the battery, use only the battery recommended by the equipment manufacturer.*

Dispose of batteries according to local ordinances and regulations.

Do not attempt to recharge a battery.

Do not attempt to disassemble, puncture, or otherwise damage a battery.

Cooling and Airflow

Caution: *Carefully route cables as directed to minimize airflow blockage and cooling problems.*

For proper cooling and airflow, operate the system only with the chassis covers installed. Operating the system without the covers in place can damage system parts. To install the covers:

- *Check first to make sure you have not left loose tools or parts inside the system.*
- *Check that cables, add-in boards, and other components are properly installed.*
- *Attach the covers to the chassis according to the product instructions.*

Laser Peripherals or Devices

Caution: *To avoid risk of radiation exposure and/or personal injury:*

- *Do not open the enclosure of any laser peripheral or device*
- *Laser peripherals or devices have are not user serviceable*
- *Return to manufacturer for servicing*

Deutsch

Sicherheitshinweise für den Server

Das vorliegende Dokument bezieht sich auf Intel® Serverplatinen, Intel® Servergehäuse (Standfuß und Rack) sowie installierte Peripheriegeräte. Es enthält Warnungen und Vorsichtsmaßnahmen zur Vermeidung von Gefahren durch Verletzung, Stromschlag, Feuer und Beschädigungen von Geräten. Lesen Sie diese Dokument daher sorgfältig, bevor Sie Ihr Intel® Serverprodukt installieren oder warten.







Bei Widersprüchen zwischen den hier vorliegenden Angaben und den Informationen im Lieferumfang des Produkts oder auf der Website des betreffenden Produkts hat die Produktdokumentation Vorrang.

Die Integration und Wartung des Servers darf nur durch technisch qualifizierte Personen erfolgen.

Um die Einhaltung der vorhandenen Zulassungen und Genehmigungen für das Produkt zu gewährleisten, sind die Richtlinien in diesem Handbuch sowie die Montageanleitungen in den Serverhandbüchern zu beachten. Verwenden Sie nur die beschriebenen, zugelassenen Komponenten, die im vorliegenden Handbuch angegeben werden. Die Verwendung anderer Produkte oder Komponenten führt zum Erlöschen der UL-Zulassung und anderer Genehmigungen für das Produkt. Dadurch kann das Produkt gegen Produktbestimmungen verstoßen, die im Verkaufsland gelten.

Sicherheitshinweise und Vorsichtsmaßnahmen

Um Verletzungen und Beschädigungen zu vermeiden, sollten Sie vor dem Beginn der Produktinstallation die nachfolgend aufgeführten Sicherheitshinweise und -informationen sorgfältig lesen und befolgen. In dem vorliegenden Handbuch sowie auf dem Produkt und auf der Verpackung werden folgende Sicherheitssymbole verwendet:

VORSICHT	Weist auf eine Gefahrenquelle hin, die bei Nichtbeachtung des VORSICHTSHINWEISES zu leichteren Verletzungen bzw. Sachbeschädigungen führen kann.
WARNUNG	Weist auf eine Gefahrenquelle hin, die bei Nichtbeachtung der WARNUNG zu ernstesten Verletzungen führen kann.
	Weist auf potentielle Gefahr bei Nichtbeachtung der angezeigten Informationen hin.
	Weist auf die Gefahr eines Stromschlags hin, der bei Nichtbeachtung der Sicherheitshinweise zu schweren oder tödlichen Verletzungen führen kann.
	Weist auf Verbrennungsgefahr an heißen Bauteilen bzw. Oberflächen hin.
	Weist darauf hin, daß das Anfassen des Gebläses zu Verletzungen führen kann.
	Bedeutet, alle Netzkabel abzuziehen und das Gerät von der Netzspannung zu trennen.
	Bereiten Sie bitte Batterie auf

Zielbenutzer der Anwendung

Dieses Produkt wurde in seiner Eigenschaft als IT-Gerät getestet, das in Büros, Schulen, Computerräumen und ähnlichen öffentlichen Räumlichkeiten installiert werden kann. Die Eignung dieses Produkts für andere Einsatzbereiche als IT (z. B. Medizin, Industrie, Alarmsysteme oder Prüfgeräte) kann u. U. weitere Tests erfordern.

Standortauswahl

Das System ist für den Betrieb innerhalb normaler Büroumgebungen geeignet. Wählen Sie einen Standort, der folgenden Kriterien entspricht:

- Sauber, trocken und frei von Partikeln in der Luft (außer dem normalen Raumstaub).
- Gut belüftet, nicht in der Nähe von Wärmequellen und keiner direkten Sonnenbestrahlung ausgesetzt.
- Nicht in der Nähe von Vibrations- oder Erschütterungsquellen.
- Abgeschirmt von starken elektromagnetischen Feldern, die durch elektrische Geräte erzeugt werden.
- In gewittergefährdeten Gebieten sollten Sie das System an einen Überspannungsschutz anschließen und bei einem Gewitter die Telekommunikationskabel zum Modem abziehen.
- Eine ordnungsgemäß geerdete Wandsteckdose muß vorhanden sein.
- Ausreichender Freiraum für den Zugang zu den Netzkabeln, da diese die Hauptvorrichtung zum Trennen des Produkts von der Stromversorgung sind.

Handhabung von Geräten

Beachten Sie zur Vermeidung von Verletzungen oder Beschädigungen an den Geräten die folgenden Hinweise:

- Halten Sie beim Transportieren und Anheben von Geräten die örtlichen Gesundheits- und Sicherheitsvorschriften ein.
- Verwenden Sie mechanische oder andere geeignete Hilfsmittel zum Transportieren oder Anheben von Geräten.
- Entfernen Sie alle Komponenten, die sich leicht abnehmen lassen, um das Gewicht zu reduzieren und die Handhabung zu erleichtern.

Warnungen zu Netzspannung und Elektrizität

Vorsicht: Durch Betätigen der mit dem Standby-Symbol gekennzeichneten Netztaste wird das System NICHT vollständig vom Netz getrennt. Es sind weiterhin 5 V aktiv, solange das System eingesteckt ist. Um das System vollständig vom Strom zu trennen, muß das Netzkabel aus der Steckdose abgezogen werden. Das System verfügt möglicherweise über mehrere Netzkabel. Vergewissern Sie sich in diesem Fall, daß alle Netzkabel abgezogen sind. Wenn Sie Komponenten ein- oder ausbauen möchten, die nicht hot-plug-fähig sind, stellen Sie sicher, daß zuvor alle Netzkabel abgezogen sind.

Nehmen Sie keine Änderungen am Netzkabel vor, und verwenden Sie kein Kabel, das nicht genau dem geforderten Typ entspricht. Jedes Netzteil im System muß über ein eigenes Netzkabel angeschlossen werden.

Einige Netzteile von Intel Servern verwenden Nullleitersicherungen. Vorsicht ist geboten im Umgang mit Netzteilen, welche Nullleitersicherungen verwenden, um das Risiko eines elektrischen Schlages zu vermeiden

Das Netzteil in diesem Produkt enthält keine Teile, die vom Benutzer gewartet werden können. Öffnen Sie das Netzteil nicht. Im Netzteil bestehen gefährliche Spannungen, Ströme und Energiequellen. Schicken Sie das Gerät für Wartungsarbeiten an den Hersteller zurück.

Wenn Sie ein hot-plug-fähiges Netzteil austauschen, ziehen Sie dessen Netzkabel ab, bevor Sie es aus dem Server ausbauen.

Zur Vermeidung von Stromschlägen schalten Sie den Server aus, und trennen Sie vor dem Öffnen des Geräts das Netzkabel sowie alle an den Server angeschlossene Telekommunikationssysteme, Netzwerke und Modems.

Hinweis für Netzkabel

Wenn kein Netzkabel mit dem Produkt geliefert wurde, kaufen Sie ein Kabel, das für die

Vorsicht: Prüfen Sie zur Vermeidung von Stromschlag- oder Feuergefahr die mit dem Produkt zu verwendenden Netzkabel wie folgt:

- Nehmen Sie keine Änderungen an einem Netzkabel vor, und benutzen sie es nicht, wenn es nicht genau in die geerdeten Netzsteckdosen paßt.
- Netzkabel müssen die folgenden Anforderungen erfüllen:
- Die Nennbelastbarkeit des Netzkabels muß mindestens so hoch sein wie die am Produkt angegebenen Nennstromaufnahme.
- Das Netzkabel muß einen zur Netzsteckdose passenden Schutzkontakt besitzen.
- Die Netzkabel sind die Hauptvorrichtung zum Trennen des Geräts vom Stromnetz. Die Steckdose muß in der Nähe der Anlage angebracht und gut erreichbar sein.
- Netzkabel müssen an eine ordnungsgemäß geerdete Steckdose angeschlossen sein.

Warnhinweise für den Systemzugang

Vorsicht: Um Verletzungen und Beschädigungen zu vermeiden, sollten Sie vor Arbeiten im Produktinneren folgende Sicherheitsanweisungen beachten:

- Schalten Sie alle am Produkt angeschlossenen Peripheriegeräte aus.
- Schalten Sie das System mit dem Netzschalter aus.
- Trennen Sie das Gerät von der Stromquelle, indem Sie alle Netzkabel vom System bzw. aus der Steckdose ziehen.
- Ziehen Sie alle Kabel und alle an das System angeschlossenen Telekommunikationsleitungen ab.
- Bewahren Sie alle Schrauben und anderen Befestigungselemente gut auf, nachdem Sie die Gehäuseabdeckung entfernt haben. Wenn Sie Ihre Arbeiten im Systeminneren beendet haben, befestigen Sie die Gehäuseabdeckung mit den Originalschrauben bzw. -befestigungselementen.
- Führen Sie keine Arbeiten im Netzteil aus. Das Netzteil enthält keine für den Benutzer wartungsbedürftigen Teile. Schicken Sie das Gerät für Wartungsarbeiten an den Hersteller zurück.
- Schalten Sie den Server aus, und ziehen Sie alle Netzkabel ab, bevor Sie Komponenten ein- oder ausbauen, die nicht hot-plug-fähig sind.
- Wenn Sie ein hot-plug-fähiges Netzteil austauschen, ziehen Sie dessen Netzkabel ab, bevor Sie es aus dem Server ausbauen.

Vorsicht: War Ihr Server in Betrieb, können die installierten Prozessoren und Kühlkörper heiß sein. Sofern Sie keine Hot-Plug-Komponenten ein- oder ausbauen, warten Sie mit dem Abnehmen der Abdeckungen, bis das System abgekühlt ist. Gehen Sie beim Aus- oder Einbauen von Hot-Plug-Komponenten sorgfältig vor, um nicht mit heißen Komponenten in Berührung zu kommen.

Vorsicht: Berühren Sie nicht die rotierenden Lüfterflügel, um Verletzungen zu vermeiden. Falls Ihr System mit einer Lüfterabdeckung besitzt, darf es nicht ohne diese Abdeckung betrieben werden.

Warnhinweise für Racks

Das Geräte-Rack muß auf einer geeigneten, festen Unterlage verankert werden, um ein Umkippen zu vermeiden, wenn ein Server oder andere Geräte herausgezogen werden. Bei der Installation des Racks müssen die Anweisungen des Rack-Herstellers beachtet werden.

Gehen Sie bei der Installation von Geräten im Rack immer von unten nach oben vor, und bauen Sie das schwerste Gerät an der untersten Position im Rack ein.

Ziehen Sie jeweils immer nur ein Gerät aus dem Rack heraus.

Sie müssen für die gesamte Rack-Einheit einen Netztrennschalter einrichten. Dieser Netztrennschalter muß leicht zugänglich sein und über eine Kennzeichnung verfügen, die besagt, daß er die Stromzufuhr zur gesamten Einheit steuert und nicht nur zu den Servern.

Zur Vermeidung von Stromschlaggefahr müssen das Rack selbst und alle darin eingebauten Geräte ordnungsgemäß geerdet sein.

Elektrostatische Entladungen (ESD)

Vorsicht: *Elektrostatische Entladungen können zur Beschädigung von Festplatten, Platinen und anderen Komponenten führen. Daher sollten Sie alle Arbeiten an einer ESD-Workstation ausführen. Steht ein solcher Arbeitsplatz nicht zur Verfügung, erzielen Sie einen gewissen Schutz vor elektrostatischen Entladungen durch Tragen einer Antistatik-Manschette, die Sie während der Arbeit zur Erdung an einem beliebigen unlackierten Metallteil des Computergehäuses befestigen.*

Gehen Sie bei der Handhabung von Platinen immer mit größter Vorsicht vor. Sie können äußerst empfindlich gegenüber elektrostatischer Entladung sein. Halten Sie Platinen nur an den Kanten fest. Legen Sie die Platinen nach dem Auspacken aus der Schutzhülle oder nach dem Ausbau aus dem Server mit der Bauelementseite nach oben auf eine geerdete, statisch entladene Unterlage. Verwenden Sie dazu, sofern verfügbar, eine leitfähige Schaumstoffunterlage, aber nicht die Schutzhülle der Platine. Ziehen Sie die Platine nicht über eine Fläche.

Andere Gefahren

Batterieaustausch

Vorsicht: Wird die Batterie unsachgemäß ausgetauscht, besteht Explosionsgefahr. Verwenden Sie als Ersatz nur die vom Gerätehersteller empfohlene Batterie.

Beachten Sie bei der Entsorgung von Batterien die gültigen Bestimmungen.

Versuchen Sie nicht, eine Batterie aufzuladen.

Versuchen Sie nicht, eine Batterie zu öffnen oder sonstwie zu beschädigen.

Kühlung und Luftstrom

Vorsicht: Verlegen Sie Kabel sorgfältig entsprechend der Anleitung, um Störungen des Luftstroms und Kühlungsprobleme zu vermeiden.

Zur Gewährleistung des ordnungsgemäßen Kühlungs- und Luftstromverhaltens darf das System nur mit angebrachten Gehäuseabdeckungen betrieben werden. Die Inbetriebnahme des Systems ohne Abdeckung kann zur Beschädigung von Systemkomponenten führen. So bringen Sie die Abdeckung wieder an:

- Vergewissern Sie sich zunächst, daß Sie keine Werkzeuge oder Teile im Gehäuse vergessen haben.
- Prüfen Sie, ob Kabel, Erweiterungskarten sowie weitere Komponenten ordnungsgemäß angebracht sind.
- Befestigen Sie die Abdeckungen am Gehäuse des Produkts, wie in dessen Anleitung beschrieben.

Laser-Peripheriegeräte oder -Komponenten

Vorsicht: Beachten Sie zur Vermeidung von Strahlung und Verletzungen die folgenden Hinweise:

- Öffnen Sie keinesfalls das Gehäuse von Laser-Peripheriegeräten oder Laser-Komponenten.
- Laser-Peripheriegeräte oder -Komponenten besitzen keine für den Benutzer wartungsbedürftigen Teile.
- Schicken Sie das Gerät für Wartungsarbeiten an den Hersteller zurück.

Français

Consignes de sécurité sur le serveur

Ce document s'applique aux cartes serveur Intel®, au châssis de serveur Intel® (sur pieds et sur rack) et aux périphériques installés. Pour réduire les risques de dommages corporels, d'électrocution, d'incendie et de dommages matériels, lisez ce document et respectez tous les avertissements et précautions mentionnés dans ce guide avant d'installer ou de mettre à jour votre produit serveur Intel®.







En cas de conflit entre les informations fournies dans ce document et celles livrées avec le produit ou publiées sur le site Web pour un produit particulier, la documentation du produit prime.

Votre serveur doit être intégré et entretenu uniquement par des techniciens qualifiés.

Vous devez suivre les informations de ce guide et les instructions d'assemblage des manuels de serveur pour vérifier et maintenir la conformité avec les certifications et approbations de produit existantes. Utilisez uniquement les composants décrits et réglementés spécifiés dans ce guide. L'utilisation d'autres produits/composants annulera la liste UL et les autres approbations réglementaires du produit, et le produit peut ne pas être conforme aux autres lois et réglementations locales applicables au produit.

Sécurité: avertissements et mises en garde

Pour éviter de vous blesser ou d'endommager votre équipement, lisez et respectez toutes les informations et consignes de sécurité avant de commencer l'installation du produit. Les symboles de sécurité suivants peuvent être utilisés tout au long de cette documentation et peuvent figurer sur le produit ou sur son emballage.

ATTENTION	Indique la présence d'un risque pouvant entraîner des blessures physiques mineures ou endommager légèrement le matériel si la mise en garde n'est pas prise en compte.
AVERTISSEMENT	Indique la présence d'un risque pouvant entraîner des blessures corporelles graves si l'avertissement n'est pas pris en compte.
	Indique un risque potentiel si les informations signalées ne sont pas prises en compte.
	Indique des risques d'électrocution pouvant entraîner des blessures corporelles graves ou mortelles si les consignes de sécurité ne sont pas respectées.
	Signale des composants ou des surfaces soumis à des températures élevées.
	Indique de ne pas toucher aux pales de ventilateur, car cela peut entraîner des blessures.
	Indique de débrancher tous les cordons d'alimentation secteur pour déconnecter l'alimentation.
	Veillez réutiliser la batterie

Domaines d'utilisation prévus

Ce produit a été testé comme équipement informatique (ITE) et peut être installé dans des bureaux, des écoles, des salles informatiques et des endroits commerciaux similaires. L'utilisation du présent produit dans des catégories et environnements de produits et domaines d'application (par exemple, le domaine médical, industriel, résidentiel, les systèmes d'alarme et les appareils de contrôle) autres qu'ITE doit faire l'objet d'évaluations supplémentaires.

Sélection d'un emplacement

Le système est conçu pour fonctionner dans un environnement standard de bureau. Choisissez un emplacement respectant les conditions suivantes :

- Propre, sec et exempt de particules en suspension (autres que la poussière normale d'une pièce).
- Bien ventilé et à l'écart des sources de chaleur telles que la lumière directe du soleil et les radiateurs.
- À l'écart des sources de vibration ou des chocs physiques.
- Isolé des champs électromagnétiques importants produits par des appareils électriques.
- Dans les régions sujettes aux orages magnétiques, nous vous recommandons de brancher votre système à un suppresseur de surtension et de déconnecter les lignes de télécommunication de votre modem pendant les orages.
- Équipé d'une prise murale reliée à la terre.
- Équipé d'un espace suffisant pour accéder aux cordons d'alimentation secteur, car ils servent de disjoncteur principal d'alimentation du produit.

Pratiques de manipulation de l'équipement

Réduisez le risque de dommages personnels ou matériels :

- Conformez-vous aux exigences de médecine du travail et de sécurité lorsque vous déplacez et soulevez le matériel.
- Utilisez l'assistance mécanique ou toute autre assistance appropriée lorsque vous déplacez et soulevez le matériel.
- Pour réduire le poids en vue de faciliter la manipulation, retirez tout composant amovible.

Alimentation et avertissements en matière d'électricité

Attention: Le bouton d'alimentation, indiqué par le symbole de mise en veille, NE COUPE PAS complètement l'alimentation secteur du système car le courant de veille 5 V reste actif lorsque le système est sous tension. Pour couper l'alimentation du système, vous devez débrancher le cordon d'alimentation secteur de la prise murale. Votre système peut utiliser plusieurs cordons d'alimentation secteur. Assurez-vous que tous les cordons d'alimentation sont débranchés. Vous devez les débrancher avant d'ouvrir le châssis, d'ajouter ou de supprimer un composant non connectable à chaud.

Les alimentations de certains serveurs Intel sont munies de doubles fusibles pôle/neutre: veuillez observer les précautions d'usage afin d'éviter tout risque d'électrocution.

N'essayez pas de modifier ou d'utiliser un cordon d'alimentation secteur s'il ne s'agit pas du type exact requis. Un cordon secteur est requis pour chaque alimentation système.

Le bloc d'alimentation de ce produit ne contient aucun composant réparable par l'utilisateur. N'ouvrez pas le bloc d'alimentation. L'intérieur de celui-ci est soumis à des niveaux dangereux de tension, de courant et d'énergie. Renvoyez-le au fabricant en cas de problème.

Lorsque vous remplacez un bloc d'alimentation à chaud, débranchez le cordon du bloc d'alimentation en cours de remplacement avant de le retirer du serveur.

Pour éviter tout risque d'électrocution, mettez le système hors tension et débranchez les cordons d'alimentation ainsi que les systèmes de télécommunication, réseaux et modems reliés au système avant d'ouvrir ce dernier.

Avertissements sur le cordon d'alimentation

Si aucun cordon d'alimentation secteur n'a été fourni avec votre produit, vous devez vous en procurer un qui soit approuvé pour une utilisation dans votre pays.

Attention: Pour éviter tout risque d'électrocution ou d'incendie, vérifiez les cordons d'alimentation qui seront utilisés avec le produit comme suit:

- N'essayez pas d'utiliser ou de modifier les cordons d'alimentation en CA s'ils ne correspondent pas exactement au type requis pour les prises électriques reliées à la terre.
- Les cordons d'alimentation doivent répondre aux critères suivants :
- Le cordon d'alimentation doit supporter une intensité supérieure à celle indiquée sur le produit.
- Le cordon d'alimentation doit posséder une broche ou un contact de mise à la terre approprié à la prise électrique.
- Les cordons d'alimentation électrique représentent le principal dispositif de déconnexion raccordé à l'alimentation secteur. Les prises de courant doivent se trouver à proximité de l'équipement et être facilement accessibles pour une déconnexion.
- Les cordons d'alimentation doivent être branchés sur des prises électriques correctement reliées à la terre.

Avertissements sur l'accès au système

Attention: Pour éviter de vous blesser ou d'endommager votre équipement, les consignes de sécurité suivantes s'appliquent chaque fois que vous accédez à l'intérieur du produit:

- Mettez hors tension tous les périphériques connectés à ce produit.
- Éteignez le système en appuyant sur le bouton d'alimentation.
- Déconnectez l'alimentation secteur en débranchant tous les cordons d'alimentation secteur du système ou de la prise murale.
- Déconnectez l'ensemble des câbles et lignes de télécommunication qui sont connectés au système.
- Mettez toutes les vis ou autres attaches de côté lorsque vous retirez les panneaux d'accès. Une fois que vous avez terminé d'accéder à l'intérieur du produit, refixez le panneau d'accès avec les vis ou attaches d'origine.
- N'essayez pas d'accéder à l'intérieur du bloc d'alimentation. Il ne contient aucune pièce réparable. Renvoyez-le au fabricant en cas de problème.
- Mettez le serveur hors tension et débranchez tous les cordons d'alimentation avant d'ajouter ou de remplacer tout composant non connectable à chaud.
- Lorsque vous remplacez le bloc d'alimentation à chaud, débranchez le cordon du bloc d'alimentation en cours de remplacement avant de retirer le bloc du serveur.

Attention: Si le serveur a été utilisé, les processeurs et dissipateurs de chaleur installés peuvent être chauds. À moins que vous n'ajoutiez ou ne retiriez un composant connectable à chaud, laissez le système refroidir avant d'ouvrir les panneaux. Pour éviter tout risque d'entrer en contact avec un composant chaud lors d'une installation à chaud, prenez toutes les précautions nécessaires lorsque vous retirez ou installez des composants connectables à chaud.

Attention: Pour éviter de vous blesser, ne touchez pas les pales de ventilateur en mouvement. Si votre système est fourni avec une protection sur le ventilateur, ne mettez pas le système en route sans la protection en place.

Avertissements sur le montage en rack

Le rack doit être fixé à un support inamovible pour éviter qu'il ne bascule lors de l'extension d'un serveur ou d'un élément de l'équipement. Le rack doit être installé conformément aux instructions du fabricant.

Installez les équipements dans le rack en partant du bas, en plaçant le plus lourd en bas du rack.

N'étendez qu'un seul élément de l'équipement à partir du rack à la fois.

Vous êtes responsable de l'installation d'un disjoncteur principal d'alimentation pour la totalité du rack. Ce disjoncteur principal doit être rapidement accessible et doit être étiqueté comme contrôlant toute l'unité, et pas uniquement le ou les serveurs.

Pour éviter tout risque d'électrocution, le rack et chaque élément de l'équipement installé dans le rack doivent être correctement reliés à la terre.

Décharges électrostatiques (ESD)

Attention: *Les décharges électrostatiques (ESD) peuvent endommager les lecteurs de disque dur, les cartes et d'autres pièces. Il est fortement conseillé d'effectuer l'ensemble des procédures décrites à un poste de travail protégé contre les ESD. Au cas où aucun poste de ce type ne serait disponible, protégez-vous contre les ESD en portant un bracelet antistatique relié à la masse du châssis (n'importe quelle surface métallique non peinte) de votre serveur lorsque que vous manipulez les pièces.*

Manipulez toujours les cartes avec précaution. Elles peuvent être extrêmement sensibles aux ESD. Ne tenez les cartes que par leurs bords. Après avoir retiré une carte de son emballage de protection ou du serveur, placez-la sur une surface reliée à la terre, exempte de charge statique, composants orientés vers le haut. Utilisez si possible un tapis de mousse conducteur, mais pas l'emballage de la carte. Veillez à ce que la carte ne glisse sur aucune surface.

Autres risques

Remplacement de la pile

Attention: Il existe un risque d'explosion si la pile n'est pas correctement remplacée. Lors du remplacement de la pile, utilisez uniquement celle recommandée par le fabricant du matériel.

Mettez la pile au rebut en vous conformant aux réglementations locales.

N'essayez pas de recharger une pile.

N'essayez pas de démonter, de percer ou d'endommager la pile d'une quelconque façon.

Refroidissement et ventilation

Attention: Routez les câbles avec précaution comme indiqué pour minimiser les blocages de circulation d'air et les problèmes de refroidissement.

Afin de permettre une ventilation et un refroidissement corrects, ne mettez le système en marche que lorsque les panneaux du châssis sont en place. L'utilisation du système sans les panneaux peut endommager les composants système. Pour installer les panneaux :

- Vérifiez tout d'abord que vous n'avez pas oublié d'outils ou de composants détachés à l'intérieur du système.
- Vérifiez que les câbles, les cartes d'extension et les autres composants sont correctement installés.
- Fixez les panneaux au châssis en suivant les instructions du produit.

Périphériques laser

Attention: Pour éviter tout risque d'exposition aux rayonnements et/ou de dommage personnel:

- N'ouvrez pas l'enceinte d'un périphérique laser.
- Les périphériques laser ne sont pas réparables par l'utilisateur.
- Retournez-les au fabricant en cas de problème.

Español

Información de seguridad del servidor

Este documento se aplica a las tarjetas de servidor de Intel[®], los gabinetes de servidor de Intel[®] (montaje en rack y en pedestal) y los dispositivos periféricos. Para reducir el riesgo de daños corporales, descargas eléctricas, fuego y en el equipo, lea este documento y preste atención a todas las advertencias y precauciones de esta guía antes de instalar o mantener el producto de servidor de Intel[®].







En el caso de que haya diferencias entre la información para un producto en particular contenida en este documento y la información proporcionada con dicho producto o en el sitio Web, la documentación del producto es la que prevalece.

Sólo personal técnico calificado debe montar y prestar los servicios para el servidor.

Debe ceñirse a las directrices de esta guía y a las instrucciones de montaje de los manuales del servidor para asegurar y mantener el cumplimiento con las certificaciones y homologaciones existentes de los productos. Utilice sólo los componentes descritos y homologados que se especifican en esta guía. El uso de otros productos o componentes anulará la homologación UL y otras certificaciones oficiales del producto, pudiendo dejar de ser compatible con las normativas locales de los países en los que se comercializa.

Advertencias y precauciones sobre seguridad

Para reducir la posibilidad de que se produzcan lesiones personales o daños en la propiedad, antes de empezar a instalar el producto, lea, observe y cumpla toda la información e instrucciones de seguridad siguientes. Puede que se utilicen los siguientes símbolos de seguridad en la documentación y es posible que aparezcan en el producto o en su embalaje.

PRECAUCIÓN	Indica la existencia de un riesgo que podría causar lesiones personales o daños en la propiedad leves si no se tiene en cuenta la PRECAUCIÓN.
ADVERTENCIA	Indica la existencia de un riesgo que podría causar lesiones personales graves si no se tiene en cuenta la ADVERTENCIA.
	Indica un riesgo potencial si no se tiene en cuenta la información indicada.
	Indica riesgo de descargas eléctricas que podrían causar lesiones graves o la muerte si no se siguen las instrucciones de seguridad.
	Indica componentes o superficies calientes.
	Indica que no se deben tocar las aspas de los ventiladores, ya que de lo contrario se podrían producir lesiones.
	Indica que es necesario desenchufar los cables de alimentación de CA para desconectar la alimentación de CA
	Recicle por favor la batería

Aplicaciones y usos previstos

Este producto ha sido evaluado como equipo de tecnología informática (ITE) que puede instalarse en oficinas, escuelas, salas de equipos informáticos o lugares de ámbito comercial similares. Es posible que sea necesario llevar a cabo una evaluación adicional para comprobar si este producto es apropiado para otras categorías de productos y entornos además de las aplicaciones informáticas (por ejemplo, soluciones médicas, industriales, residenciales, sistemas de alarma y equipos de pruebas).

Selección de la ubicación

El sistema se ha diseñado para funcionar en un entorno normal de oficinas. Seleccione una ubicación que esté:

- Limpia, seca y libre de macropartículas en suspensión en el aire (que no sean el polvo habitual de la habitación).
- Bien ventilada y alejada de fuentes de calor, incluida la luz solar directa y los radiadores.
- Alejada de fuentes de vibración o de golpes físicos.
- Aislada de campos electromagnéticos producidos por dispositivos eléctricos.
- En zonas propensas a tormentas eléctricas, se recomienda que conecte el servidor a un supresor de sobretensiones y desconecte las líneas de telecomunicaciones al módem durante una tormenta eléctrica.
- Provista de una toma de corriente alterna correctamente conectada a tierra.
- Provista de espacio suficiente para acceder a los cables de la fuente de alimentación ya que constituyen la desconexión principal de la alimentación.

Manipulación del equipo

Reduzca el riesgo de daños personales o en el equipo:

- Respete los requisitos de sanidad y seguridad laborales de su país cuando traslade y levante el equipo.
- Utilice medios mecánicos u otros que sean adecuados al trasladar o levantar el equipo.
- Para que el peso sea menor para manipularlo con más facilidad, extraiga los componentes que sean de fácil extracción.

Advertencias de alimentación y eléctricas

Precaución: El botón de encendido, indicado con la marca del modo de reposo o stand-by, NO DESCONECTA completamente la alimentación de CA del sistema, ya que el modo de reposo de 5 V sigue activo mientras el sistema está enchufado. Para desconectar el sistema debe desenchufar el cable de alimentación de CA de la toma de la pared. Puede usar más de un cable de alimentación de CA con el sistema. Asegúrese de que todos los cables de alimentación de CA están desenchufados. Asegúrese de que los cables de alimentación de CA estén desenchufado antes de abrir el gabinete, agregar o extraer cualquier componente que no es de conexión en funcionamiento.

Algunas fuentes de alimentación de electricidad de los servidores de Intel utilizan el polo neutral del fuselaje. Para evitar riesgos de choques eléctricos use precauciones al trabajar con las fuentes de alimentación que utilizan el polo neutral de fuselaje.

No intente modificar ni utilizar un cable de alimentación de CA si no es del tipo exacto requerido. Se necesita un cable de CA para cada fuente de alimentación del sistema.

La fuente de alimentación de este producto no contiene piezas que puedan ser reparadas por el usuario. No abra la fuente de alimentación. Dentro de la fuente de alimentación puede haber niveles de tensión, corriente y energía peligrosos. Devuélvala al fabricante para repararla.

Al reemplazar una fuente de alimentación de conexión en funcionamiento, desenchufe el cable de alimentación de la fuente de alimentación que va a reemplazar antes de extraerla del servidor.

Para evitar el riesgo de descargas eléctricas, antes de abrir el servidor, apáguelo, desconecte el cable de alimentación, los sistemas de telecomunicaciones, las redes y los módems conectados al mismo.

Advertencias sobre el cable de alimentación

Si no se ha proporcionado con el producto ningún cable de alimentación de CA, adquiera alguno cuyo uso esté aprobado en su país.

Precaución: Para evitar descargas eléctricas o fuego, revise los cables de alimentación que usará con el producto tal y como se describe a continuación:

- No intente modificar ni utilizar los cables de alimentación de CA si no son exactamente del modelo especificado para ajustarse a las tomas de corriente conectadas a tierra
- Los cables de alimentación deben reunir los siguientes requisitos:
- El cable de alimentación debe disponer de una capacidad nominal de corriente eléctrica mayor que la capacidad especificada en el producto.
- El cable de alimentación debe disponer de una patilla o contacto de conexión a tierra que sea apto para la toma de corriente.
- Los cables de la fuente de alimentación son los dispositivos de desconexión principales a la corriente alterna. El enchufe o enchufes de zócalo deben encontrarse cerca del equipo y el acceso a ellos debe poderse efectuar de forma inmediata con el fin de desconectarlos.

- Los cables de la fuente de alimentación deben estar conectados a los enchufes con una toma de tierra adecuada.

Advertencias el acceso al sistema

Precaución: Para evitar lesiones personales o daños en la propiedad, se aplican las siguientes instrucciones de seguridad siempre que se acceda al interior del producto:

- Apague todos los dispositivos periféricos conectados a este producto.
- Pulse el botón de alimentación para apagar el sistema.
- Desconecte la alimentación de CA desenchufando los cables de alimentación de CA del sistema o de la toma de corriente alterna.
- Desconecte todos los cables y líneas de telecomunicación que estén conectados al sistema.
- Guarde todos los tornillos o elementos de fijación cuando retire las cubiertas de acceso. Cuando termine de operar en el interior del producto, vuelva a colocar los tornillos o los elementos de fijación originales de la cubierta de acceso.
- No acceda al interior de la fuente de alimentación. No hay elementos en la fuente de alimentación que usted pueda reparar y utilizar. Devuélvala al fabricante para repararla.
- Apague el servidor y desconecte todos los cables de alimentación antes de agregar o reemplazar cualquier componente que no es de conexión en funcionamiento.
- Al reemplazar una fuente de alimentación de conexión en funcionamiento, desenchufe el cable de alimentación de la fuente de alimentación que va a reemplazar antes de extraerla del servidor.

Precaución: Si el servidor se ha estado ejecutando, los procesadores y disipadores de calor estarán recalentados. A no ser que esté instalando o extrayendo un componente de conexión en funcionamiento, deje que el sistema se enfríe antes de abrir las cubiertas. Para que no llegue a tocar los componentes que estén calientes cuando esté realizando una instalación de conexión en funcionamiento, tenga cuidado al extraer o instalar los componentes de conexión en funcionamiento.

Precaución: Para evitar posibles daños, no toque las aspas en movimiento de los ventiladores. Si el sistema se le ha suministrado con una protección para el ventilador, asegúrese de que cuando esté funcionando el sistema la protección esté en su sitio.

Advertencias sobre el montaje en rack

El rack para el equipo se debe sujetar con un soporte fijo para evitar que se caiga cuando se extraiga un servidor o una pieza del mismo. El rack debe instalarse siguiendo las instrucciones del fabricante del bastidor.

Instale el equipo en el rack comenzando desde la parte de abajo, con el equipo más pesado en la parte inferior del rack.

Extraiga las piezas del equipo del rack de una a una.

El usuario es el responsable de la instalación de un dispositivo de desconexión de la alimentación principal para toda la unidad del rack. El acceso a este dispositivo de desconexión deberá ser de fácil acceso y deberán incluirse indicaciones que lo identifiquen como el control de alimentación eléctrica de toda la unidad, no sólo de los servidores.

Para evitar el riesgo de descargas eléctricas, deberá instalar una conexión a tierra apropiada para el rack y para cada pieza del equipo instalada en el mismo.

Descarga electrostática (ESD)

Precaución: *Las descargas electrostáticas pueden dañar las unidades de disco, las tarjetas y otros componentes. Recomendamos que realice todos los procedimientos en una estación de trabajo protegida contra descargas electrostáticas. En caso de que no haya una disponible, protéjase de alguna forma contra las descargas llevando un brazalete antiestático conectado a la toma de tierra de la carcasa (cualquier superficie de metal que no esté pintada) del servidor cuando manipule las piezas.*

Manipule siempre las tarjetas con el máximo cuidado. Pueden ser sumamente sensibles a las descargas electrostáticas. Sujételas sólo por los bordes. Una vez extraída la tarjeta de su envoltorio de protección o del servidor, colóquela con el lado de los componentes hacia arriba sobre una superficie con toma de tierra y sin carga estática. Utilice una almohadilla de espuma conductora si dispone de ella, pero nunca el envoltorio de la tarjeta. No deslice la tarjeta sobre ninguna superficie.

Sustitución de la batería

Precaución: Existe el peligro de explosión si la batería no se reemplaza correctamente. Al reemplazar la batería, utilice sólo la batería recomendada por el fabricante del equipo.

Deseche las baterías respetando la normativa local.

No intente recargar la batería.

No intente desmontar, pinchar o causar cualquier otro desperfecto a una batería.

Enfriamiento y circulación de aire

Precaución: El tendido de los cables debe realizarse cuidadosamente tal y como se le indica para reducir al mínimo los problemas de obstrucción de la ventilación y de refrigeración.

Para conseguir una refrigeración y corriente de aire adecuadas, compruebe que cuando sistema esté funcionando, las cubiertas de la carcasa están instaladas. Si utiliza el sistema sin las cubiertas, podría dañar sus componentes. Para instalar las cubiertas:

- *Compruebe primero que no ha dejado herramientas o piezas sueltas dentro del sistema.*
- *Compruebe que los cables, tarjetas adicionales y otros componentes están instalados correctamente.*
- *Sujete las cubiertas a la carcasa siguiendo las instrucciones del producto.*

Periféricos o dispositivos láser

Precaución: Para evitar el riesgo de la exposición a radiaciones o de daños personales:

- *No abra la caja de ningún periférico o dispositivo láser*
- *Los periféricos o dispositivos láser no pueden ser reparados por el usuario*
- *Haga que el fabricante los repare.*

简体中文

服务器安全信息

本文档适用于 Intel® 服务器主板、Intel® 服务器机箱（基座和机架固定件）和已安装的外设。为减少人身伤害、电击、火灾以及设备损坏的危险，请在安装或维护 Intel® 服务器产品之前阅读本文档并遵循本指南中的所有警告和预防措施。





如果本文档中的信息与特定产品的随附信息或 Web 站点信息之间存在不一致，请以产品文档为准。

服务器须由合格的技术人员进行集成和维护。

必须遵守本指南的规定和服务器手册的装配指导，以确保符合现有的产品认证和审批。仅使用本指南中描述和规定的指定组件。使用其他产品 / 组件将使产品的 UL 认证和其他管理审批无效，并可能导致产品不符合销售地的产品法规。

安全警告与注意事项

为避免人身伤害与财产损失，安装本产品之前，请阅读以下所有安全指导和信息。下面所列的安全符号可能在整个文档中使用并可能标注于产品和 / 或产品包装之上。

注意	表示如果无视此“ ??? 项” ??????? 轻微人身伤害或财产损失的危险。
警告	表示如果无视此“ ?? ” ??????? 严重人身伤害的危险。
	表示如果无视所示信息，即存在潜在的危险。
	表示如果不遵守安全指导，存在可导致严重伤害或死亡的电击危险。
	表示灼热组件或表面。
	表示请勿触摸风机叶片，否则可能致伤。
	表示拔下所有交流电线，断开交流电源

预期应用使用

根据评估，本产品为信息技术设备 (ITE)，可安装在办公室、学校、计算机房和类似的商业场所。本产品对于非 ITE 应用的其他产品种类和环境（如医疗、工业、住宅、报警系统和测试设备）的适用性尚有待进一步的评估。

场地选择

本系统专为在典型办公环境运行而设计。请选择符合以下条件的地点：

- 清洁、干燥，无气载微粒（而非一般的室内尘埃）。
- 通风良好，远离热源（包括直接日晒和散热器）。
- 远离振动源或物理震动。
- 与电气设备产生的强大电磁场隔离。
- 在易受闪电袭击的地区，我们建议将系统插入电涌抑制器并在闪电期间断开通信线路与调制解调器之间的连接。
- 提供正确接地的墙壁插座。
- 提供足够的空间，以便拿取电源供应线，因为这是本产品的主要电源断开器。

设备操作规范

减少人身伤害或设备受损的危险：

- 移举设备时遵守当地的职业健康与安全要求。
- 借助机械手段或其他合适的手段移举设备。
- 拆除一切易分离组件，以降低重量并方便操作。

电源与电气警告

⚠️ 注意事项

电源按钮（如待机电源标记所示）并不能完全关闭系统的交流电源，只要系统已接通电源，就存在 5V

待机电源。要从系统切断电源，须从墙壁电源插座中拔下交流电线。您的系统可能不止使用一根交流电线。请确保所有的交流电线都已拔下。打开机箱或增加或删除任何热插拔组件之前，确保交流电线已拔下。

若非所需的确切类型，请勿尝试修改或使用交流电线。系统的每个电源供应设备都需要一根单独的交流电线。

本产品的电源供应设备包含非用户维修部件。请勿打开电源供应设备。电源供应设备包含非常危险的电压级、电流级和能量级。请与生产商联系维修事宜。

替换热插拔电源供应设备时，请先拔下需替换的电源供应设备上的电源线，再将其从服务器上移除。

为避免电击，请在打开服务器之前，关闭服务器并断开服务器上连接的电源线、电信系统、网络和调制解调器。

电源线警告

如果产品未提供交流电线，请购买一根您所在国家批准使用的交流电线。

注意事项

为避免电击或火灾危险，请按如下所述对产品所用的电源线进行检查：

- 若非所需的符合接地插座的确切类型，请勿尝试修改或使用交流电线
- 电源线须符合以下标准：
 - 电源线的电气额定值须大于产品上标注的电流额定值。
 - 电源线须拥有适合插座的安全接地插头或触点。
- 电源线为交流电源的主要断开设备。插座须靠近设备并可随时断开。
- 电源线须插入所提供的拥有合适接地的插座。

系统使用警告

注意事项

为避免人身伤害或财产损失，无论何时检查产品内部，以下安全指导都适用：

- 关闭所有与本产品相连的外设。
- 按下电源按钮至关闭状态，关闭系统。
- 从系统或墙壁插座上拔下所有交流电线，断开交流电源。
- 断开与系统相连的所有线缆和通信线路。
- 卸除舱口盖时，保留所有螺钉及其他紧固件。完成产品内部检查之后，请用螺钉或紧固件重新固定舱口盖。
- 请勿打开电源供应设备。电源供应设备内没有可维修部件。请与生产商联系维修事宜。
- 增加或替换任何非热插拔组件之前，请关闭服务器电源并断开所有电源线。
- 替换热插拔电源供应设备时，请先拔下需替换的电源供应设备上的电源线，然后再从服务器上移除电源供应设备。

注意事项

如果服务器一直在运行，任何已安装的处理器和吸热设备都可能很热。除非要增加或移除热插拔组件，否则请待系统冷却后再开盖。为避免在热插拔组件安装过程中接触灼热组件，移除或安装热插拔组件时务须小心。

注意事项

为避免受伤，请勿触摸运转的风机叶片。如果系统的风机上配有防护装置，请勿卸下风机防护装置运行系统。

机架固定件警告

设备的机架须固定在稳固的支座上，以防从中安装服务器或设备时倒塌。须按照机架生产商提供的安装说明进行安装。

从下往上将设备安装在机架上，最重的设备安装在机架的最底层。

一次只从机架上安装一件设备。

您须负责安装整个机架装置的主要电源断开设备。此主要断开设备须随时可用，且须标明为控制整个装置（而不仅限于服务器）的电源。

为避免潜在的电击危险，须对机架及其上所安装的每一件设备实行正确的安全接地。

静电放电 (ESD)

注意事项

ESD 会损坏磁盘驱动器、主板及其他部件。我们建议您执行 ESD 工作站的所有步骤。如果没有 ESD 工作站，则采取一些静电放电保护措施，操作部件时，戴上与服务器上的机箱接地或任何未喷漆金属表面连接的防静电腕带。

操作主板时始终保持小心。它们可能对 ESD 非常敏感。拿持主板时只接触边缘。从保护包装中或从服务器上取出主板后，请将主板组件侧面朝上放置于无静电的接地表面上。请使用导电泡沫垫（若有），不要使用主板包装。请勿将主板在任何表面上滑动。

其他危险

替换电池

注意事项

不正确替换电池可能导致爆炸危险。替换电池时，请只使用设备生产商推荐使用的电池。

请按当地法规处置电池。

请勿对电池充电。

请勿拆卸、刺穿或以其他方式损坏电池。

冷却和气流

注意事项

按照说明小心布置线缆，尽量减少气流阻塞和冷却问题。

为保证适当的冷却和气流，运行系统时请确保机箱盖已安装。未安装机箱盖即运行系统可能导致系统部件受损。安装机箱盖的步骤如下：

- 首先检查并确保系统内没有遗留的未固定工具或部件。
- 检查线缆、内插板和其他组件已正确安装。
- 按产品说明安装机箱盖。

激光外设或激光设备

注意事项



为避免辐射暴露和 / 或人身伤害：



- 请勿打开任何激光外设或激光设备的外壳
- 激光外设或激光设备为非用户维修设备

请与生产商联系维修事宜

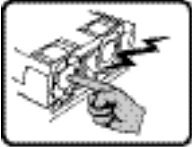
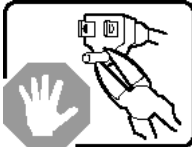
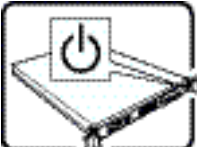

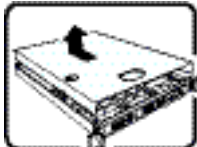
E Installation/Assembly Safety Instructions

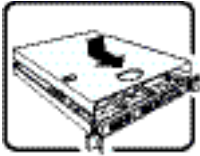
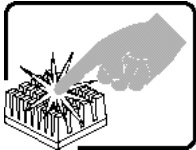
English

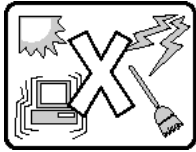
	<p>The power supply in this product contains no user-serviceable parts. Refer servicing only to qualified personnel.</p>
	<p>Do not attempt to modify or use the supplied AC power cord if it is not the exact type required. A product with more than one power supply will have a separate AC power cord for each supply.</p>
	<p>The power button on the system does not turn off system AC power. To remove AC power from the system, you must unplug each AC power cord from the wall outlet or power supply.</p> <p>The power cord(s) is considered the disconnect device to the main (AC) power. The socket outlet that the system plugs into shall be installed near the equipment and shall be easily accessible.</p>
	<p>SAFETY STEPS: Whenever you remove the chassis covers to access the inside of the system, follow these steps:</p> <ol style="list-style-type: none"> 1. Turn off all peripheral devices connected to the system. 2. Turn off the system by pressing the power button. 3. Unplug all AC power cords from the system or from wall outlets. 4. Label and disconnect all cables connected to I/O connectors or ports on the back of the system. 5. Provide some electrostatic discharge (ESD) protection by wearing an antistatic wrist strap attached to chassis ground of the system-any unpainted metal surface-when handling components. 6. Do not operate the system with the chassis covers removed.
	<p>After you have completed the six SAFETY steps above, you can remove the system covers. To do this:</p> <ol style="list-style-type: none"> 1. Unlock and remove the padlock from the back of the system if a padlock has been installed. 2. Remove and save all screws from the covers. 3. Remove the cover(s).

	<p>For proper cooling and airflow, always reinstall the chassis covers before turning on the system. Operating the system without the covers in place can damage system parts. To install the covers:</p> <ol style="list-style-type: none"> 1. Check first to make sure you have not left loose tools or parts inside the system. 2. Check that cables, add-in boards, and other components are properly installed. 3. Attach the covers to the chassis with the screws removed earlier, and tighten them firmly. 4. Insert and lock the padlock to the system to prevent unauthorized access inside the system. 5. Connect all external cables and the AC power cord(s) to the system.
	<p>A microprocessor and heat sink may be hot if the system has been running. Also, there may be sharp pins and edges on some board and chassis parts. Contact should be made with care. Consider wearing protective gloves.</p>
	<p>Danger of explosion if the battery is incorrectly replaced. Replace only with the same or equivalent type recommended by the equipment manufacturer. Dispose of used batteries according to manufacturer's instructions.</p>
	<p>The system is designed to operate in a typical office environment. Choose a site that is:</p> <ul style="list-style-type: none"> • Clean and free of airborne particles (other than normal room dust). • Well ventilated and away from sources of heat including direct sunlight. • Away from sources of vibration or physical shock. • Isolated from strong electromagnetic fields produced by electrical devices. • In regions that are susceptible to electrical storms, we recommend you plug your system into a surge suppressor and disconnect telecommunication lines to your modem during an electrical storm. • Provided with a properly grounded wall outlet. • Provided with sufficient space to access the power supply cord(s), because they serve as the product's main power disconnect.

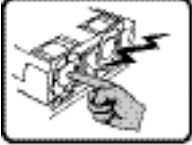
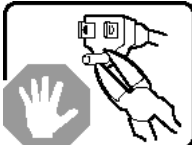
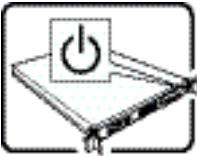
Deutsch

	<p>Benutzer können am Netzgerät dieses Produkts keine Reparaturen vornehmen. Das Produkt enthält möglicherweise mehrere Netzgeräte. Wartungsarbeiten müssen von qualifizierten Technikern ausgeführt werden.</p>
	<p>Versuchen Sie nicht, das mitgelieferte Netzkabel zu ändern oder zu verwenden, wenn es sich nicht genau um den erforderlichen Typ handelt. Ein Produkt mit mehreren Netzgeräten hat für jedes Netzgerät ein eigenes Netzkabel.</p>
	<p>Der Wechselstrom des Systems wird durch den Ein-/Aus-Schalter für Gleichstrom nicht ausgeschaltet. Ziehen Sie jedes Wechselstrom-Netzkabel aus der Steckdose bzw. dem Netzgerät, um den Stromanschluß des Systems zu unterbrechen.</p>
	<p>SICHERHEISSMASSNAHMEN: Immer wenn Sie die Gehäuseabdeckung abnehmen um an das Systeminnere zu gelangen, sollten Sie folgende Schritte beachten:</p> <ol style="list-style-type: none">1. Schalten Sie alle an Ihr System angeschlossenen Peripheriegeräte aus.2. Schalten Sie das System mit dem Hauptschalter aus.3. Ziehen Sie den Stromanschlußstecker Ihres Systems aus der Steckdose.4. Auf der Rückseite des Systems beschriften und ziehen Sie alle Anschlußkabel von den I/O Anschlüssen oder Ports ab.5. Tragen Sie ein geerdetes Antistatik Gelenkband, um elektrostatische Ladungen (ESD) über blanke Metallstellen bei der Handhabung der Komponenten zu vermeiden.6. Schalten Sie das System niemals ohne ordnungsgemäß montiertes Gehäuse ein.

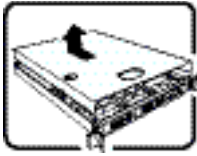
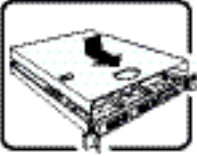
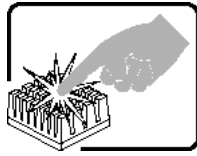
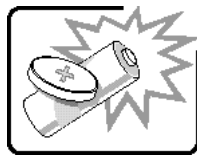

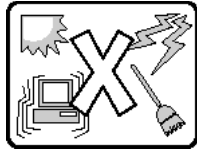
	<p>SICHERHEISSMASSNAHMEN: Immer wenn Sie die Gehäuseabdeckung abnehmen um an das Systeminnere zu gelangen, sollten Sie folgende Schritte beachten:</p> <ol style="list-style-type: none"> 1. Schalten Sie alle an Ihr System angeschlossenen Peripheriegeräte aus. 2. Schalten Sie das System mit dem Hauptschalter aus. 3. Ziehen Sie den Stromanschlußstecker Ihres Systems aus der Steckdose. 4. Auf der Rückseite des Systems beschriften und ziehen Sie alle Anschlußkabel von den I/O Anschlüssen oder Ports ab. 5. Tragen Sie ein geerdetes Antistatik Gelenkband, um elektrostatische Ladungen (ESD) über blanke Metallstellen bei der Handhabung der Komponenten zu vermeiden. 6. Schalten Sie das System niemals ohne ordnungsgemäß montiertes Gehäuse ein.
	<p>Zur ordnungsgemäßen Kühlung und Lüftung muß die Gehäuseabdeckung immer wieder vor dem Einschalten installiert werden. Ein Betrieb des Systems ohne angebrachte Abdeckung kann Ihrem System oder Teile darin beschädigen. Um die Abdeckung wieder anzubringen:</p> <ol style="list-style-type: none"> 1. Vergewissern Sie sich, daß Sie keine Werkzeuge oder Teile im Innern des Systems zurückgelassen haben. 2. Überprüfen Sie alle Kabel, Zusatzkarten und andere Komponenten auf ordnungsgemäßen Sitz und Installation. 3. Bringen Sie die Abdeckungen wieder am Gehäuse an, indem Sie die zuvor gelösten Schrauben wieder anbringen. Ziehen Sie diese gut an. 4. Bringen Sie die Verschlusseinrichtung (Padlock) wieder an und schließen Sie diese, um ein unerlaubtes Öffnen des Systems zu verhindern. 5. Schließen Sie alle externen Kabel und den AC Stromanschlußstecker Ihres Systems wieder an.
	<p>Der Mikroprozessor und der Kühler sind möglicherweise erhitzt, wenn das System in Betrieb ist. Außerdem können einige Platinen und Gehäuseteile scharfe Spitzen und Kanten aufweisen. Arbeiten an Platinen und Gehäuse sollten vorsichtig ausgeführt werden. Sie sollten Schutzhandschuhe tragen.</p>
	<p>Bei falschem Einsetzen einer neuen Batterie besteht Explosionsgefahr. Die Batterie darf nur durch denselben oder einen entsprechenden, vom Hersteller empfohlenen Batterietyp ersetzt werden. Entsorgen Sie verbrauchte Batterien den Anweisungen des Herstellers entsprechend.</p>



Das System wurde für den Betrieb in einer normalen Büroumgebung entwickelt. Der Standort sollte:

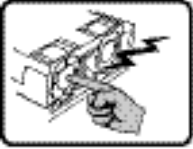
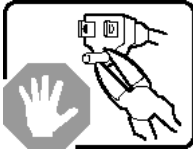
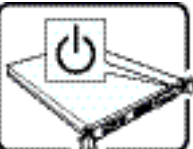

- "sauber und staubfrei sein (Hausstaub ausgenommen);
- "gut gelüftet und keinen Heizquellen ausgesetzt sein (einschließlich direkter Sonneneinstrahlung);
- "keinen Erschütterungen ausgesetzt sein;
- "keine starken, von elektrischen Geräten erzeugten elektromagnetischen Felder aufweisen;
- "in Regionen, in denen elektrische Stürme auftreten, mit einem Überspannungsschutzgerät verbunden sein; während eines elektrischen Sturms sollte keine Verbindung der Telekommunikationsleitungen mit dem Modem bestehen;
- "mit einer geerdeten Wechselstromsteckdose ausgerüstet sein;
- "über ausreichend Platz verfügen, um Zugang zu den Netzkabeln zu gewährleisten, da der Stromanschluß des Produkts hauptsächlich über die Kabel unterbrochen wird

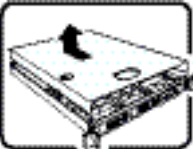
Français

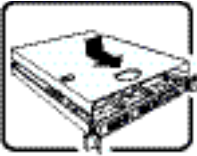
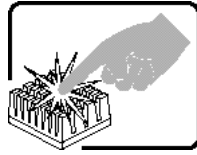
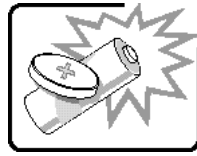
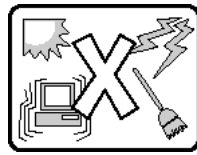
	<p>Le bloc d'alimentation de ce produit ne contient aucune pièce pouvant être réparée par l'utilisateur. Ce produit peut contenir plus d'un bloc d'alimentation. Veuillez contacter un technicien qualifié en cas de problème.</p>
	<p>Ne pas essayer d'utiliser ni modifier le câble d'alimentation CA fourni, s'il ne correspond pas exactement au type requis. Le nombre de câbles d'alimentation CA fournis correspond au nombre de blocs d'alimentation du produit</p>
	<p>Notez que le commutateur CC de mise sous tension /hors tension du panneau avant n'éteint pas l'alimentation CA du système. Pour mettre le système hors tension, vous devez débrancher chaque câble d'alimentation de sa prise.</p>
	<p>CONSIGNES DE SÉCURITÉ -Lorsque vous ouvrez le boîtier pour accéder à l'intérieur du système, suivez les consignes suivantes:</p> <ol style="list-style-type: none">1. Mettez hors tension tous les périphériques connectés au système.2. Mettez le système hors tension en mettant l'interrupteur général en position OFF (bouton-poussoir).3. Débranchez tous les cordons d'alimentation c.a. du système et des prises murales.4. Identifiez et débranchez tous les câbles reliés aux connecteurs d'E-S ou aux accès derrière le système.5. Pour prévenir les décharges électrostatiques lorsque vous touchez aux composants, portez une bande antistatique pour poignet et reliez-la à la masse du système (toute surface métallique non peinte du boîtier).6. Ne faites pas fonctionner le système tandis que le boîtier est ouvert.
	<p>Une fois TOUTES les étapes précédentes accomplies, vous pouvez retirer les panneaux du système. Procédez comme suit:</p> <ol style="list-style-type: none">1. Si un cadenas a été installé sur à l'arrière du système, déverrouillez-le et retirez-le.2. Retirez toutes les vis des panneaux et mettez-les dans un endroit sûr.3. Retirez les panneaux.

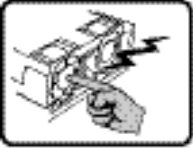
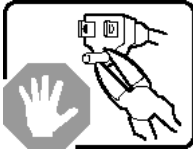
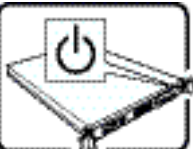

	<p>Afin de permettre le refroidissement et l'aération du système, réinstallez toujours les panneaux du boîtier avant de mettre le système sous tension. Le fonctionnement du système en l'absence des panneaux risque d'endommager ses pièces. Pour installer les panneaux, procédez comme suit:</p> <ol style="list-style-type: none"> 1. Assurez-vous de ne pas avoir oublié d'outils ou de pièces démontées dans le système. 2. Assurez-vous que les câbles, les cartes d'extension et les autres composants sont bien installés. 3. Revissez solidement les panneaux du boîtier avec les vis retirées plus tôt. 4. Remettez le cadenas en place et verrouillez-le afin de prévenir tout accès non autorisé à l'intérieur du système. 5. Rebranchez tous les cordons d'alimentation c. a. et câbles externes au système.
	<p>Le microprocesseur et le dissipateur de chaleur peuvent être chauds si le système a été sous tension. Faites également attention aux broches aiguës des cartes et aux bords tranchants du capot. Nous vous recommandons l'usage de gants de protection.</p>
	<p>Danger d'explosion si la batterie n'est pas remontée correctement. Remplacer uniquement avec une batterie du même type ou d'un type équivalent recommandé par le fabricant. Disposez des piles usées selon les instructions du fabricant.</p>
	<p>Le système a été conçu pour fonctionner dans un cadre de travail normal. L'emplacement choisi doit être:</p> <ul style="list-style-type: none"> • "Propre et dépourvu de poussière en suspension (sauf la poussière normale). • "Bien aéré et loin des sources de chaleur, y compris du soleil direct. • "A l'abri des chocs et des sources de vibrations. • "Isolé de forts champs électromagnétiques géenérés par des appareils électriques. • "Dans les régions sujettes aux orages magnétiques il est recomandé de brancher votre système à un supresseur de surtension, et de débrancher toutes les lignes de télécommunications de votre modem durant un orage. • "Muni d'une prise murale correctement mise à la terre. • "Suffisamment spacieux pour vous permettre d'accéder aux câbles d'alimentation (ceux-ci étant le seul moyen de mettre le système hors tension).

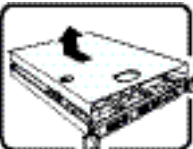
Español

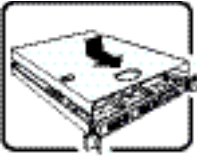
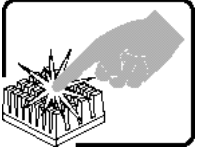
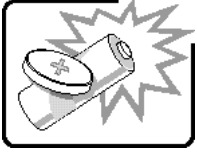
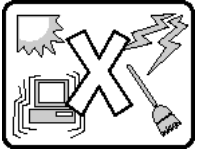
	<p>El usuario debe abstenerse de manipular los componentes de la fuente de alimentación de este producto, cuya reparación debe dejarse exclusivamente en manos de personal técnico especializado. Puede que este producto disponga de más de una fuente de alimentación</p>
	<p>No intente modificar ni usar el cable de alimentación de corriente alterna, si no corresponde exactamente con el tipo requerido. El número de cables suministrados se corresponden con el número de fuentes de alimentación de corriente alterna que tenga el producto</p>
	<p>Nótese que el interruptor activado/desactivado en el panel frontal no desconecta la corriente alterna del sistema. Para desconectarla, deberá desenchufar todos los cables de corriente alterna de la pared o desconectar la fuente de alimentación.</p>
	<p>INSTRUCCIONES DE SEGURIDAD: Cuando extraiga la tapa del chasis para acceder al interior del sistema, siga las siguientes instrucciones:</p> <ol style="list-style-type: none">1. Apague todos los dispositivos periféricos conectados al sistema.2. Apague el sistema presionando el interruptor encendido/apagado.3. Desconecte todos los cables de alimentación CA del sistema o de las tomas de corriente alterna.4. Identifique y desconecte todos los cables enchufados a los conectores E/S o a los puertos situados en la parte posterior del sistema.5. Cuando manipule los componentes, es importante protegerse contra la descarga electrostática (ESD). Puede hacerlo si utiliza una muñequera antiestática sujeta a la toma de tierra del chasis - o a cualquier tipo de superficie de metal sin pintar.6. No ponga en marcha el sistema si se han extraído las tapas del chasis.
	<p>Después de completar las seis instrucciones de SEGURIDAD mencionadas, ya puede extraer las tapas del sistema. Para ello:</p> <ol style="list-style-type: none">1. Desbloquee y extraiga el bloqueo de seguridad de la parte posterior del sistema, si se ha instalado uno.2. Extraiga y guarde todos los tornillos de las tapas. Extraiga las tapas.

	<p>Para obtener un enfriamiento y un flujo de aire adecuados, reinstale siempre las tapas del chasis antes de poner en marcha el sistema. Si pone en funcionamiento el sistema sin las tapas bien colocadas puede dañar los componentes del sistema. Para instalar las tapas:</p> <ol style="list-style-type: none"> 1. Asegúrese primero de no haber dejado herramientas o componentes sueltos dentro del sistema. 2. Compruebe que los cables, las placas adicionales y otros componentes se hayan instalado correctamente. 3. Incorpore las tapas al chasis mediante los tornillos extraídos anteriormente, tensándolos firmemente. 4. Inserte el bloqueo de seguridad en el sistema y bloquéelo para impedir que pueda accederse al mismo sin autorización. 5. Conecte todos los cables externos y los cables de alimentación CA al sistema.
	<p>Si el sistema ha estado en funcionamiento, el microprocesador y el disipador de calor pueden estar aún calientes. También conviene tener en cuenta que en el chasis o en el tablero puede haber piezas cortantes o punzantes. Por ello, se recomienda precaución y el uso de guantes protectores.</p>
	<p>Existe peligro de explosión si la pila no se cambia de forma adecuada. Utilice solamente pilas iguales o del mismo tipo que las recomendadas por el fabricante del equipo. Para deshacerse de las pilas usadas, siga igualmente las instrucciones del fabricante.</p>
	<p>El sistema está diseñado para funcionar en un entorno de trabajo normal. escoja un lugar:</p> <ul style="list-style-type: none"> • "Limpio y libre de partículas en suspensión (salvo el polvo normal). • "Bien ventilado y alejado de fuentes de calor, incluida la luz solar directa. • "Alejado de fuentes de vibración. • "Aislado de campos electromagnéticos fuertes producidos por dispositivos eléctricos. • "En regiones con frecuentes tormentas eléctricas, se recomienda conectar su sistema a un eliminador de sobrevoltage y desconectar el módem de las líneas de telecomunicación durante las tormentas. • "Provisto de una toma de tierra correctamente instalada. • "Provisto de espacio suficiente como para acceder a los cables de alimentación, ya que éstos hacen de medio principal de desconexión del sistema.

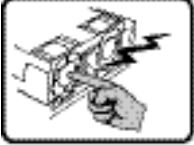
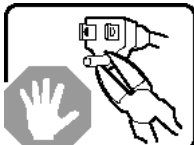
Italiano

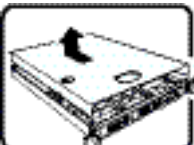
	<p>Rivolgersi ad un tecnico specializzato per la riparazione dei componenti dell'alimentazione di questo prodotto. È possibile che il prodotto disponga di più fonti di alimentazione.</p>
	<p>Non modificare o utilizzare il cavo di alimentazione in c.a. fornito dal produttore, se non corrisponde esattamente al tipo richiesto. Ad ogni fonte di alimentazione corrisponde un cavo di alimentazione in c.a. separato</p>
	<p>L'interruttore attivato/disattivato nel pannello anteriore non interrompe l'alimentazione in c.a. del sistema. Per interromperla, è necessario scollegare tutti i cavi di alimentazione in c.a. dalle prese a muro o dall'alimentazione di corrente.</p>
	<p>PASSI DI SICUREZZA: Qualora si rimuovano le coperture del telaio per accedere all'interno del sistema, seguire i seguenti passi:</p> <ol style="list-style-type: none">1. Spegner tutti i dispositivi periferici collegati al sistema.2. Spegner il sistema, usando il pulsante spento/acceso dell'interruttore del sistema.3. Togliere tutte le spine dei cavi del sistema dalle prese elettriche.4. Identificare e sconnettere tutti i cavi attaccati ai collegamenti I/O od alle prese installate sul retro del sistema.5. Qualora si tocchino i componenti, proteggersi dallo scarico elettrostatico (SES), portando un cinghia anti-statica da polso che è attaccata alla presa a terra del telaio del sistema - qualsiasi superficie non dipinta - .6. Non far operare il sistema quando il telaio è senza le coperture.
	<p>Dopo aver seguito i sei passi di SICUREZZA sopracitati, togliere le coperture del telaio del sistema come segue:</p> <ol style="list-style-type: none">1. Aprire e rimuovere il lucchetto dal retro del sistema qualora ve ne fosse uno installato.2. Togliere e mettere in un posto sicuro tutte le viti delle coperture.3. Togliere le coperture.

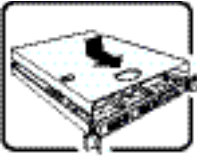
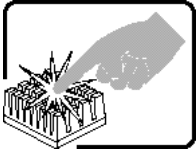
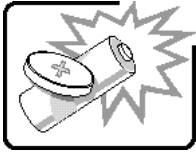
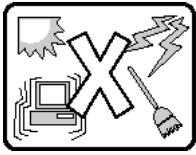
	<p>Per il giusto flusso dell'aria e raffreddamento del sistema, rimettere sempre le coperture del telaio prima di riaccendere il sistema. Operare il sistema senza le coperture al loro proprio posto potrebbe danneggiare i componenti del sistema. Per rimettere le coperture del telaio:</p> <ol style="list-style-type: none"> 1. Controllare prima che non si siano lasciati degli attrezzi o dei componenti dentro il sistema. 2. Controllare che i cavi, dei supporti aggiuntivi ed altri componenti siano stati installati appropriatamente. 3. Attaccare le coperture al telaio con le viti tolte in precedenza e avvitarle strettamente. 4. Inserire e chiudere a chiave il lucchetto sul retro del sistema per impedire l'accesso non autorizzato al sistema. 5. Ricollegare tutti i cavi esterni e le prolunghe AC del sistema.
	<p>Se il sistema è stato a lungo in funzione, il microprocessore e il dissipatore di calore potrebbero essere surriscaldati. Fare attenzione alla presenza di piedini appuntiti e parti taglienti sulle schede e sul telaio. È consigliabile l'uso di guanti di protezione.</p>
	<p>Esiste il pericolo di un'esplosione se la pila non viene sostituita in modo corretto. Utilizzare solo pile uguali o di tipo equivalente a quelle consigliate dal produttore. Per disfarsi delle pile usate, seguire le istruzioni del produttore.</p>
	<p>Il sistema è progettato per funzionare in un ambiente di lavoro tipo. Scegliere una postazione che sia:</p> <ul style="list-style-type: none"> • "Pulita e libera da particelle in sospensione (a parte la normale polvere presente nell'ambiente). • "Ben ventilata e lontana da fonti di calore, compresa la luce solare diretta. • "Al riparo da urti e lontana da fonti di vibrazione. • "Isolata dai forti campi magnetici prodotti da dispositivi elettrici. • "In aree soggette a temporali, è consigliabile collegare il sistema ad un limitatore di corrente. In caso di temporali, scollegare le linee di comunicazione dal modem. • "Dotata di una presa a muro correttamente installata. • "Dotata di spazio sufficiente ad accedere ai cavi di alimentazione, i quali rappresentano il mezzo principale di scollegamento del sistema.

