

Software User's Guide

Intel[®] Embedded Server RAID Technology II, Intel[®] Integrated Server RAID, and Intel[®] RAID Controllers SRCAS18E and SRCAS144E

April 2006

D29305-004

INFORMATION IN THIS DOCUMENT IS PROVIDED IN CONNECTION WITH INTEL PRODUCTS. NO LICENSE, EXPRESS OR IMPLIED, BY ESTOPPEL OR OTHERWISE, TO ANY INTELLECTUAL PROPERTY RIGHTS IS GRANTED BY THIS DOCUMENT. EXCEPT AS PROVIDED IN INTEL'S TERMS AND CONDITIONS OF SALE FOR SUCH PRODUCTS, INTEL ASSUMES NO LIABILITY WHATSOEVER, AND INTEL DISCLAIMS ANY EXPRESS OR IMPLIED WARRANTY, RELATING TO SALE AND/OR USE OF INTEL PRODUCTS INCLUDING LIABILITY OR WARRANTIES RELATING TO FITNESS FOR A PARTICULAR PURPOSE, MERCHANTABILITY, OR INFRINGEMENT OF ANY PATENT, COPYRIGHT OR OTHER INTELLECTUAL PROPERTY RIGHT. Intel products are not intended for use in medical, life saving, life sustaining applications.

Intel may make changes to specifications and product descriptions at any time, without notice.

Copyright © 2006 by Intel Corporation. Portions Copyright © 2005-2006 by LSI Logic Corporation. All rights reserved.

Intel is a trademark or registered trademark of Intel Corporation or its subsidiaries in the United States and other countries.

*Other names and brands may be claimed as the property of others.

Contents

1 Overview	1
Intel® RAID Controller Software and Utilities	1
Intel® RAID Controller Drivers	2
Intel® Embedded Server RAID Technology II BIOS Configuration Utility	2
Intel® RAID BIOS Console 2 Configuration Utility for Intelligent RAID	3
Intel® RAID Web Console 2 Configuration and Monitoring Utility	3
Levels of RAID	4
RAID 0 - Data Striping	4
RAID 1 - Disk Mirroring/Disk Duplexing	4
RAID 5 - Data Striping with Striped Parity	5
RAID 10 - Combination of RAID 1 and RAID 0	5
RAID 50 - Combination of RAID 5 and RAID 0	6
Drive Hierarchy within the RAID Firmware	6
Intel® RAID Controllers SRCAS18E and SRCAS144E Features.	7
Enterprise Features	7
Fault Tolerant Features	8
Cache Options and Settings	8
Background Tasks	9
Error Handling	9
Audible Alarm.	10
2 Intel® RAID Drivers	11
Windows* System Driver Installation	11
RAID Driver Installation on New Windows Operating System	11
RAID Driver Installation on Existing Windows Operating System	12
RAID Driver Installation for Red Hat* Enterprise Linux.	12
RAID Driver Installation for SuSE* Linux	13
3 Intel® Embedded Server RAID BIOS Configuration Utility	15
Creating, Adding or Modifying a Logical Drive Configuration	16
Setting the Write Cache and Read Ahead Policies.	17
Working with a Global Hotspare Drive	18
Adding a Hot Spare Drive	18
Removing a Hot Spare Drive	18
Rebuilding a Drive.	19
Auto Rebuild and Auto Resume	19
Checking Data Consistency	19
Viewing and Changing Device Properties.	20
Forcing a Drive Online or Offline.	20
Configuring a Bootable Logical Drive	20
Deleting (Clearing) a Storage Configuration	21
4 Intel® RAID BIOS Console 2 Utility	23
Quick Configuration Steps	23
Detailed Configuration Steps using the Intel® RAID BIOS Console 2	24
Start the BIOS Console 2 Utility	24
Screen and Option Descriptions	24

Configuration Wizard	30
Creating RAID 0, 1, or 5 through the RAID BIOS Console 2 (detailed)	32
RAID 10 and RAID 50 Creation Using BIOS Console 2	36
Setting Drive Parameters	41
Creating a Hot Spare	42
Viewing Event Details	45
5 Intel® RAID Web Console 2	47
Configuration Functions	47
Monitoring Functions	47
Maintenance Functions	47
Hardware and Software Requirements	48
Installing the Intel® RAID Web Console 2 on a Windows Operating System	48
Installing the Intel® RAID Web Console 2 on Linux or SUSE SLES	50
Startup, Overview, and Setup of Intel® RAID Web Console 2	50
Intel® RAID Web Console 2 Screens	51
Physical/Logical View Panel	52
Properties/Operations/Graphical View Panel	53
Event Log Panel	54
Menu Bar / File Menu	54
Menu Bar / Operations Menu	54
File Menu / Group Operations Menu	55
File Menu / Log Menu	55
File Menu / Help Menu	55
Drive Configuration Tasks	55
Configuration Wizards	55
Creating a New Configuration	56
Guided Configuration	64
Creating a Spanned Disk Array or Disk Group	67
Creating Hot Spares	69
Setting Adjustable Task Rates	71
Adding a Drive to a Virtual Disk	72
Removing a Drive from a Virtual Disk	75
Changing the RAID Level of a Virtual Disk	77
Changing Virtual Disk Properties	78
Deleting a Virtual Disk	78
Managing Configurations	79
Saving a Configuration to Disk	79
Clearing a Configuration from a Controller	81
Adding a Configuration from a File	82
Monitoring System Events and Devices	83
Monitoring System Events	83
Monitoring Controllers	84
Monitoring Disk Drives and Other Physical Devices	85
Monitoring Virtual Disks	88
Monitoring Enclosures	89
Monitoring Battery Backup Units	90
Monitoring Rebuilds and Other Processes	91
Maintaining and Managing Storage Configurations	92
Initializing a Virtual Disk	92
Running a Consistency Check	93

Scanning for New Drives	94
Rebuilding a Drive	94
Removing a Drive	96
Flashing the Firmware	96
Appendix A Configuring RAID 0, 1, or 5 using Custom Configuration	97
Appendix B Events and Messages	103

Figures

Figure 1. RAID 0 - Data Striping	4
Figure 2. RAID 1 - Disk Mirroring/Disk Duplexing.....	4
Figure 3. RAID 5 - Data Striping with Striped Parity	5
Figure 4. RAID 10 - Combination of RAID 1 and RAID 0	5
Figure 5. RAID 50 - Combination of RAID 5 and RAID 0	6
Figure 6. Intel® Embedded Server RAID BIOS Configuration Utility Screen	15
Figure 7. Intel® RAID BIOS Console 2 Menu	25
Figure 8. Adapter Properties.....	26
Figure 9. Additional Adapter Properties.....	27
Figure 10. BIOS Console 2 - Adapter Selection	29
Figure 11. BIOS Console 2 - Configuration Types	30
Figure 12. BIOS Console 2 - Configuration Methods	31
Figure 13. BIOS Console 2 - Add Physical Drives to Array	32
Figure 14. BIOS Console 2 - Set Array Properties	33
Figure 15. BIOS Console 2 - Confirm Configuration.....	34
Figure 16. BIOS Console 2 - Initialization Speed Setting	35
Figure 17. RAID BIOS Console 2 Utility – Multiple Disk Groups for RAID 10 or 50	36
Figure 18. RAID BIOS Console 2 – Spanning Multiple Arrays	37
Figure 19. RAID BIOS Console 2 – Viewing Completed Settings	38
Figure 20. RAID BIOS Console 2 – Initialization Settings	39
Figure 21. RAID BIOS Console 2 – RAID 10 Final Screen	39
Figure 22. RAID BIOS Console 2 – RAID 10 Properties Screen.....	40
Figure 23. RAID BIOS Console 2 – RAID 50 Properties Screen.....	40
Figure 24. RAID BIOS Console 2 – Choosing a Hot Spare Drive	42
Figure 25. RAID BIOS Console 2 – Setting a Hot Spare Drive	43
Figure 26. RAID BIOS Console 2 – Viewing Hot Spare	43
Figure 27. RAID BIOS Console 2 – Main Screen showing Hot Spare Drive	44
Figure 28. RAID BIOS Console 2 – Event Information Screen.....	45
Figure 29. RAID BIOS Console 2 – Selecting Events to View.....	46
Figure 30. RAID BIOS Console 2 – Viewing an Event	46
Figure 31. Intel® RAID Web Console 2 – Customer Information Screen.....	48
Figure 32. Setup Type Screen.....	49
Figure 33. Intel® RAID Web Console 2 – Select Server Screen.....	51
Figure 34. Intel® RAID Web Console 2 – Login Screen	51
Figure 35. Intel® RAID Web Console 2 – Main Screen	52
Figure 36. Intel® RAID Web Console 2 – Operations Tab.....	53
Figure 37. Intel® RAID Web Console 2 – Graphical Tab.....	54
Figure 38. Intel® RAID Web Console 2 – Starting Configuration Wizard.....	56
Figure 39. Intel® RAID Web Console 2 – Selecting Type of Configuration	56
Figure 40. Intel® RAID Web Console 2 – Auto Configuration Screen	57
Figure 41. Intel® RAID Web Console 2 – First Manual Configuration Screen.....	58
Figure 42. Intel® RAID Web Console 2 – Selecting Drive for Hotspare.....	59
Figure 43. Intel® RAID Web Console 2 – New Disk Group with Hotspare	60
Figure 44. Intel® RAID Web Console 2 – Defining a Virtual Disk	61
Figure 45. Manual Configuration – New Configuration.....	62
Figure 46. Manual Configuration – Virtual Disk Summary	63

Figure 47. First Guided Configuration Screen	64
Figure 48. Guided Configuration – Parameters	65
Figure 49. Final Guided Configuration Screen	66
Figure 50. Defining the Spanned Array	67
Figure 51. New Spanned Array	68
Figure 52. Make Global Hotspare	69
Figure 53. Creating a Dedicated Hotspare	70
Figure 54. Select Hotspare Drive.....	70
Figure 55. Set Adjustable Task Rates	71
Figure 56. Starting Reconstruction Wizard	72
Figure 57. Reconstruction Wizard	73
Figure 58. Selecting Drives to Add	73
Figure 59. Drive Selected for Virtual Disk.....	74
Figure 60. Changing RAID Level	74
Figure 61. Select Drives to Remove from logical drive.....	75
Figure 62. Drive Selected for Removal from logical drive.....	76
Figure 63. Select RAID Level	76
Figure 64. Selecting RAID Level.....	77
Figure 65. Set Virtual Disk Properties.....	78
Figure 66. Save Configuration to File	79
Figure 67. Save Configuration Dialog Box.....	80
Figure 68. Clear Configuration.....	81
Figure 69. Add Saved Configuration.....	82
Figure 70. Event Information Window.....	83
Figure 71. Controller Information	84
Figure 72. Physical Drive Information	85
Figure 73. Locating Physical Drive	86
Figure 74. Patrol Read Configuration	87
Figure 75. Virtual Disk Properties	88
Figure 76. Enclosure Information - Graphical View	89
Figure 77. Battery Backup Unit Information.....	90
Figure 78. Group Show Progress Window	91
Figure 79. Selecting Initialize	92
Figure 80. Group Consistency Check Window	93
Figure 81. Scan for Foreign Configuration.....	94
Figure 82. Preparing Drive for Removal	95
Figure 83. Flashing the Firmware	96
Figure 84. Starting Configuration Wizard.....	97
Figure 85. Selecting Manual Configuration.....	98
Figure 86. Selecting Drives for RAID 0.....	98
Figure 87. Drives Selected for RAID 0.....	99
Figure 88. Configure RAID 0 Parameters.....	99
Figure 89. Accepting RAID 0 Parameters.....	100
Figure 90. Completing RAID 0 Configuration	100
Figure 91. RAID 0 in Logical Tab.....	101

1 Overview

Intel® Server Boards that are based on the Intel® S5000 chipset offer multiple native mode and RAID options:

- All ESB2-based server boards provide six SATA ports capable of 1.5 and 3.0 Gbps data transfer rates with a BIOS option to enable Intel® Embedded Server RAID Technology II.
- All SAS server boards provide four through eight ports of Serial Attached SCSI (SAS), which includes SATA drive support at 1.5 and 3.0 Gbps data transfer rates. Native SAS mode supports up to 120 physical drives through expanders. A BIOS option enables Intel® Embedded Server RAID Technology II.
- ROMB server boards offer a variety of modes from native SAS support to Intel® Integrated Server RAID.

Intel® Embedded Server RAID Technology II provides software RAID 0, 1, and 10 for up to six SATA drives or up to eight SAS / SATA drives. Intel® Integrated Server RAID allows an onboard RAID solution to be upgraded to full intelligent XOR RAID by adding the Intel® RAID Activation Key AXXRAK18E and DDR2 RAM. Because the Intel® IOP processor is already available on the server board, the upgrade to provide full-featured intelligent RAID is added at a minimal cost.

The Intel® RAID Controllers SRCAS18E and SRCAS144E provide a cost-effective, flexible, intelligent add-in RAID solution. Intel® intelligent RAID controllers include a high-performance Intel® I/O processor, a multi-port SAS controller, RAM for caching data transfers, high-speed data bus interconnect to drives, and support for RAID levels 0, 1, 5, 10, and 50.

This document describes the software and utilities, available RAID modes, and instructions for configuring and maintaining RAID arrays. The software described in this document is designed for use only with Intel® RAID Controllers with SAS support or ESB2 SATA support.

Caution: Some levels of RAID are designed to increase the availability of data and some to provide data redundancy. However, installing a RAID controller is not a substitute for a reliable backup strategy. It is highly recommended that all data be backed up regularly via a tape drive or other backup strategy to guard against data loss. It is especially important to back up all data before working on any system components and before installing or changing the RAID controller or configuration.

Intel® RAID Controller Software and Utilities

Intel® Embedded Server RAID Technology II and Intel® Integrated Server RAID controllers include a powerful set of software tools for configuring and managing RAID systems. The firmware that is installed on the RAID controller provides pre-operating system configuration.

For Intel® Embedded Server RAID Technology II, press <Ctrl>+<E> during the server boot to enter the BIOS configuration utility. For Intel® Integrated Server RAID, press <Ctrl>+<G> during the server boot to enter the RAID BIOS Console II.

Intel® RAID Controller Drivers

A driver is provided for the operating system interface and the Intel® RAID Web Console 2 is provided to monitor, manage, and update the RAID configuration. Intel provides software drivers for the following operating systems:

- Microsoft Windows 2000*, XP*, and 2003* (32-bit and X64 editions)
- Red Hat* Enterprise Linux 3.0 and 4.0 (AS, ES, WS – both X86 and X86-64)
- SuSE* Linux Enterprise Server 9.0 with SP1 (both X86 and X86-64)

This manual provides installation instructions to install the drivers for each of the above operating systems.

Driver features include the following:

- Online mirror rebuilding
- Consistency check for mirrored disks

Caution: Only combinations of controller, driver, and Intel® Server board or system listed in the Tested Hardware and Operating System List (THOL) have been tested. Check the supported OS list for both your chosen RAID controller and your server board to verify OS support and compatibility.

Intel® Embedded Server RAID Technology II BIOS Configuration Utility

With support for up to six SATA drives or eight SAS / SATA drives, depending on the server board or system, the embedded RAID BIOS has the following features:

- Support for interrupt 13 and Int19h.
- Support for SATA CD-ROM / DVD-ROM devices, including support for booting from a CD-ROM drive.
- POST and run-time BIOS support for device insertion and removal.
- Support for a up to 2 terabyte physical and logical drives.
- Support for a migration path from Intel® Embedded Server RAID Technology II to Intel® Integrated Server RAID hardware.
- Automatic resume of rebuilding, check consistency, and initialization.
- Global hot spare support based on the logical drive size.
- Support for RAID levels 0, 1, and 10.
- Support for auto rebuild.
- Support for different capacity disks in the same array.
- Support for up to eight physical drives and eight logical drives.
- Stripe size of 64 Kbytes only.
- Support for disk coercion with options of None, 128 Mbytes, 1 Gbyte.
- Ability to select a logical drive as boot device. By default, logical drive 0 is bootable.

Intel® RAID BIOS Console 2 Configuration Utility for Intelligent RAID

The Intel® RAID BIOS Console 2 configuration utility provides full-featured, GUI-based configuration and management of RAID arrays. The Intel® RAID BIOS Console 2 utility resides in the controller firmware and is independent of the operating system. The Intel® RAID BIOS Console 2 configuration utility lets you:

- Select an Intel® RAID controller
- Choose a configuration method for physical arrays, disk groups, and logical drives
- Create drive arrays
- Define logical drives
- Initialize logical drives
- Access controllers, logical drives, and physical arrays to display their properties
- Create hot spare drives
- Rebuild failed drives
- Verify data redundancy in RAID 1, 5, 10, or 50 logical drives

Intel® RAID Web Console 2 Configuration and Monitoring Utility

The Intel® RAID Web Console 2 is an operating system-based, object-oriented GUI utility that configures and monitors RAID systems locally or over a network. The Intel® RAID Web Console 2 runs on each of the supported Windows and Linux operating systems.

With the Intel® RAID Web Console 2, you can perform the same tasks as you can with the Intel® RAID BIOS Console 2 or with the Intel® Embedded Server RAID BIOS Configuration utility. In addition, the Intel® RAID Web Console 2 provides on-the-fly RAID migration, creating almost limitless adaptability and expansion of any logical drive while the system remains operational.

The Intel® RAID Web Console 2 allows you to:

- Create and manage logical drives
- Add a drive to a RAID logical drive
- Convert from a RAID 0 configuration to a RAID 1 or 5 configuration by adding a physical drive
- Change a degraded redundant logical drive to an optimal RAID 0 logical drive
- Remove physical drives from a logical drive
- Convert a RAID 1 or 5 logical drive to a RAID 0 drive

Levels of RAID

RAID 0 - Data Striping

In RAID 0, data is split into blocks called stripes, and stripes are written to alternating drives. RAID 0 usually requires at least two drives and may consist of up to 8 physical SATA drives or 16 SAS devices. The stripe size is user configured. RAID 0 provides significant improvement of the data throughput but does not provide data redundancy. When one hard disk fails, all data is lost. Because RAID 0 does not provide data redundancy, all drive space is available for data and there is no need for a hot spare drive. A single drive can be set to provide RAID 0 as a method to pass a single drive through to the operating system.

RAID 0 improves performance for video streaming and high-speed applications because data is stored and retrieved across multiple drives. Do not use RAID 0 to store critical data.

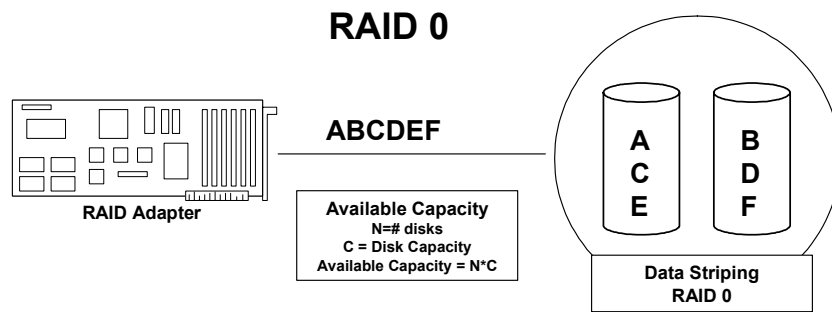

Figure 1. RAID 0 - Data Striping

RAID 1 - Disk Mirroring/Disk Duplexing

RAID 1 requires two drives because all data is stored twice, once each on two identical disks, making one drive a mirror image of the other. If one hard disk fails, all data is immediately available on the other without an impact on performance. If both drives are on a single channel, the term is Disk Mirroring. If each drive is on a separate channel, the term is Disk Duplexing. Because all data is duplicated, only half of the total drive space can be counted as available space.

RAID 1 is an easy and highly efficient way to provide data redundancy and system availability and is ideal for the operating system drive or databases. Use a hot spare drive and any disk failure will start an automatic rebuild of the data onto the hot spare drive.

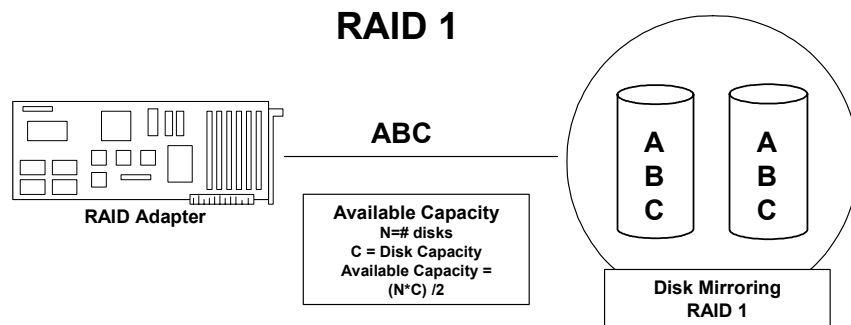

Figure 2. RAID 1 - Disk Mirroring/Disk Duplexing

RAID 5 - Data Striping with Striped Parity

RAID 5 works by striping data across multiple drives, but it also provides data redundancy by calculating and writing data checksums (parity). If one drive fails, all data remains fully available. Missing data is recalculated from the remaining data and parity information.

RAID 5 balances throughput and redundancy and requires at least three drives. Multi-user, multi-tasking environments typically use small data blocks, which are well suited to RAID 5.

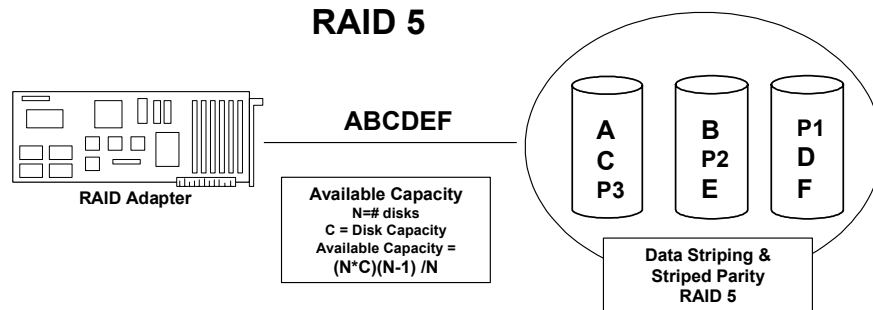

Figure 3. RAID 5 - Data Striping with Striped Parity

RAID 10 - Combination of RAID 1 and RAID 0

RAID 10 is a combination of RAID 0 and RAID 1, which gives a blend of performance and redundancy without requiring parity calculations or writes. Best performance is achieved in highly sequential load situations but one half of the capacity is lost to redundancy. RAID 10 requires a minimum of two and up to eight RAID 1 arrays and each array must contain exactly two drives. RAID 10 will tolerate one drive failure per stripe set, meaning two total drives could be lost as long as they are in separate RAID 1 arrays. A hot spare drive can be used in any position.

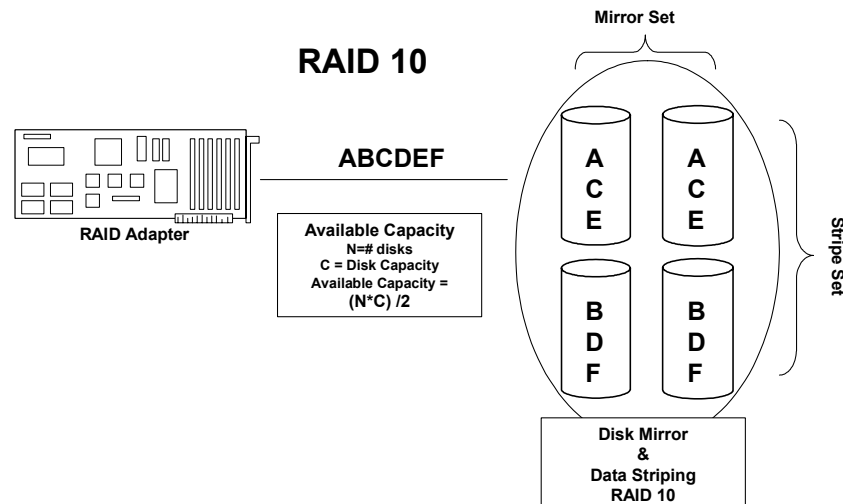

Figure 4. RAID 10 - Combination of RAID 1 and RAID 0

RAID 50 - Combination of RAID 5 and RAID 0

Like RAID 10, RAID 50 is created by first creating multiple RAID 5 arrays or disk groups and spanning a logical drive across them. RAID 50 arrays or disk groups provide the excellent performance of RAID 5 with added data security. RAID 50 requires a minimum of six drives and can span a maximum of eight RAID 5 arrays or disk groups. RAID 50 will tolerate a single drive failure per stripe.

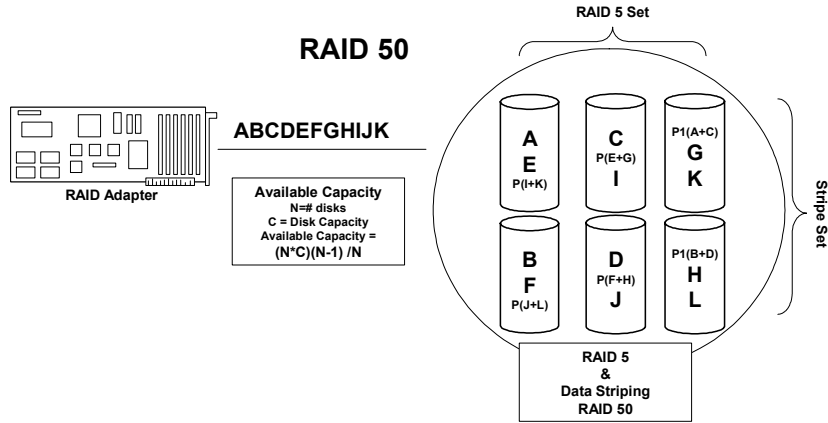

Figure 5. RAID 50 - Combination of RAID 5 and RAID 0

Drive Hierarchy within the RAID Firmware

The Intel[®] Integrated RAID firmware is based on three fundamental levels. Logical drives are created from drive arrays that are created from physical drives.

- **Level 1** consists of the physical drives (hard drives and removable hard disks). The firmware identifies each drive by its physical ID and maps it to a virtual address. A logical drive can be constructed of more than one physical drive.
- **Level 2** consists of the array(s) formed by firmware made of one or more disks and can be made into RAID 0, 1, 5, 10, or 50.
- **Level 3** consists of the logical drives. These are the only drives that can be accessed by the operating system. These are the drives given drive letters (C, D, etc.) under a Windows* operating system. The firmware automatically transforms each newly installed drive array into a logical drive. RAID 0, 1, and 5 use a single array and RAID 10 and 50 use multiple arrays.

Intel® RAID Controllers SRCAS18E and SRCAS144E Features

Enterprise Features

- Online capacity expansion (OCE). Add capacity to the logical drive. The added capacity can be presented to the operating system as additional space for the operating system to partition it as an additional drive, or it may be added to an operating system drive, depending upon the capability of the operating system.
- Online RAID level migration allows for upgrading a RAID level. Options are to go from RAID 1 to RAID 0, RAID 5 to RAID 0. With OCE, options are to go from RAID 0 to RAID 1, RAID 0 to RAID 5, and from RAID 1 to RAID 5.
 - You cannot migrate or perform OCE on a spanned RAID array or disk group (RAID 10 or RAID 50).
 - You cannot migrate to a smaller capacity configuration.
 - You cannot perform OCE when there is more than one logical drive on a logical array or disk group.
- 128 logical drives are allowed per controller.
- Smart Initialization automatically checks consistency of logical drives for RAID 5 when five or more disks are used. This allows performance optimization by enabling read-modify-write mode of operation with five or more disks in a RAID 5 array or disk group. Peer read mode of operation is used when the RAID 5 array or disk group contains three or four physical drives.
- The initialization or rebuild process will automatically resume on the next boot if the system shuts down. Auto resume must be enabled prior to logical drive creation.
- Stripe size is user definable on a per drive basis and can be 8, 16, 32, 64, or 128 KB in size. The default is 64 KB, which is optimal for many data access types.
- Hot spares can be set as global or dedicated. A global hot spare will automatically come online to replace the first drive to fail on any array or disk group on the controller. A dedicated hot spare is assigned to a specific array or disk group and will only come online to rebuild a failed drive in that array or disk group. A hot spare will only come online if it is the same size or larger than the failing drive (see drive coercion below), and if a drive has been marked as failed. If a drive is removed (and marked as failed) within a logical drive, the hot spare will automatically come online. However, there must be disk activity (I/O to the drive) in order for a missing drive to be marked as failed.
- Drive coercion refers to the ability of the controller to recognize the size of the physical drives that are connected and then force the larger drives to use only the amount of space available on the smallest drive. Drive coercion allows an option to map out a reserved space to compensate for slightly smaller drive sizes that may be added later. The default is set to 1 GB. The coercion algorithm options are:
 - None: No coercion of size.
 - 128M: The software rounds the drive capacity down to the next 128 MB boundary and then up to the nearest 10 MB until the coerced capacity is larger than the actual drive size. It is then reduced by 10 MB.
 - 1G: The software rounds the drive capacity down to the nearest 1 GB boundary and then down by 1 MB. This corresponds to the terms most drive manufacturers use.

Fault Tolerant Features

- Configuration on Disk (COD) and NVRAM storage of array and disk group configuration information. Array and disk group configuration information is stored both on the hard drive (COD) and in NVRAM. This helps protect against loss of the configuration due to adapter and/or drive failure.
- Failed drives are automatically detected and a transparent rebuild of the failed drive automatically occurs using a hot spare drive.
- Support for SAF-TE enabled enclosures allows enhanced drive failure and rebuild reporting via enclosure LEDs; support also includes hot swapping of hard drives.
- A battery backup for cache memory is available as an option. RAID controller firmware automatically checks for the presence of the battery module, and if found, allows the write back cache option. The adapter continuously tracks the battery voltage and reports if the battery is low. When low, the battery is first given a fast charge to replenish the charge and is then given a trickle charge to keep it at an optimal power level. Adapters that support the battery module include a “dirty cache” LED; when power is lost to the system and data remains in the cache memory that has not been written to disk, this LED signals that this operation needs to be completed. Upon reboot, the data in memory can then be written to the hard disk drive.
- Although I/O performance may be lower, hard disk drive write-back cache is disabled by default because data can potentially be lost if a power outage occurs. Enabling the HDD write-back cache may improve performance, but when enabled, a UPS device should be used to prevent data loss during power outages.
- Battery life is about three years. Battery health should be monitored and the battery replaced when needed.
- SMART technology is supported. This provides a higher level of predictive failure analysis of the hard disk drives by the RAID controller.

Cache Options and Settings

Cache options and settings can be unique for each logical drive.

- Cache Write Policy
 - Write Through: I/O completion is signaled only after the data is written to hard disk.
 - Write Back: I/O completion is signaled when data is transferred to cache.
- Cache Policy
 - Direct I/O: When possible, no cache is involved for both reads and writes. The data transfers will be directly from host system to the disk and from the disk to the host system.
 - Cached I/O: All reads will first look at cache. If a cache hit occurs, the data will be read from cache; if not, the data will be read from disk and the read data will be buffered into cache. All writes to drive are also written to cache.
- Read Policy
 - No Read Ahead: Provides no read ahead for the logical drive.
 - Read Ahead: Additional consecutive stripes/lines are read and buffered into cache.
 - Adaptive: The read-ahead will be automatically turned on and off depending upon whether the disk is accessed for sequential reads or random reads.

Background Tasks

- Rebuilding a failed drive is performed in the background. The rebuild rate is tunable from 0-100%.
 - The rebuild rate controls the amount of system resources allocated to the rebuild.

Caution: It is not recommended to increase the rebuild rate to over 50%. A higher rebuild rate can result in operating system requests not being serviced in a timely fashion and causing an operating system error.

- A consistency check scans the consistency of data on a fault-tolerant disk to determine if data has been corrupted.
- Background initialization is a background check of consistency. It has the same functionality as the check consistency option but is automatic and can be canceled only temporarily. If it is canceled, it will start again in a few minutes. Background initialization is only performed on redundant volumes.
- RAID level migration and online capacity expansion are completed in the background.
- Patrol Read is a user definable option available in the Intel[®] RAID Web Console 2 that performs drive reads in the background and maps out any bad areas of the drive.

Error Handling

- Most commands are retried four or more times. The firmware is programmed to provide the best effort to recognize an error and recover from it if possible.
- Failures are logged and stored in NVRAM. OS-based errors are viewable from the event viewer in the Web Console 2.
- RAID-related errors can be reported by the hard drive firmware, SAF-TE controller, or the RAID controller firmware. These errors may be reported to the operating system through RAID management software, through SMART monitoring, or through CIM management. Some errors may also be reported by the SAF-TE controller and logged in the system event log (SEL) for the Intel[®] server board. In addition, access errors may be reported by the operating system. Depending on the RAID controller and drive enclosure, the error may be evident via the color of LEDs, the flashing of LEDs, or audible alarms.

Audible Alarm

The following list of beep tones is used on the Intel[®] RAID Controllers SRCSAS18E and SRCSAS144E. These beeps usually indicate that a drive has failed.

- Degraded Array or Disk Group: Short tone, 1 second on, 1 second off
- Failed Array or Disk Group: Long tone, 3 seconds on, 1 second off
- Hot Spare Commissioned - Short tone, 1 second on, 3 seconds off

The tone alarm will stay on during a rebuild. After the rebuild completes, an alarm with a different tone will sound.

The disable alarm option in either the BIOS Console 2 or the Web Console 2 management utilities will hold the alarm disabled after a power cycle. The enable alarm option must be used to re-enable the alarm.

The silence alarm option in either the BIOS Console 2 or the Web Console 2 management utilities will silence the alarm until a power cycle or another event occurs.

2 Intel® RAID Drivers

The drivers that Intel provides for the Intel® RAID Controllers SRCAS18E and SRCAS144E are not compatible with SCSI or SATA-only RAID controllers. The RAID driver files are available on the *Resource CD* that accompanies the Intel RAID controllers. The driver files are also available at http://downloadfinder.intel.com/scripts-df-external/Support_Intel.aspx. Files can be copied to a floppy diskette or to a USB key for transfer to another system.

Note: Intel updates software frequently and later drivers may provide additional features. Check for later software at the Intel web site: <http://support.intel.com/support/motherboards/server/>. See the readme file that accompanies the download for updated information.

Windows* System Driver Installation

RAID Driver Installation on New Windows Operating System

This procedure installs the RAID device driver system during the Windows 2003*, Windows 2000*, or Windows XP* operating system installation. The system must contain an Intel RAID controller. Windows 2003 automatically adds the driver to the registry and copies the driver to the appropriate directory.

1. Start the Windows installation by booting from the Windows CD-ROM disk. The system BIOS must support booting from a CD-ROM drive. You may need to change BIOS settings to allow CD-ROM booting. See your system documentation for instructions.
2. Press <F6> to install when the screen displays:
Press F6 if you need to install...

Note: You must press <F6> for the system to recognize the new driver.

3. Choose <S> to specify an additional device when the screen displays:
Setup could not determine the type...

Note: If this screen is not displayed as the first user input, then the <F6> key press was not seen by the setup program. Reboot the system and return to step 2.

4. When the system asks for the manufacturer-supplied hardware support disk, insert the Windows driver diskette and press <Enter>.
5. Select the appropriate Windows driver from the menu by highlighting it. Press <Enter> to proceed. The driver is added to the registry and copied to the appropriate directory.
6. Continue with the Windows operating system installation procedure.

RAID Driver Installation on Existing Windows Operating System

This procedure installs or upgrades the RAID device driver on an existing Windows 2003, Windows 2000, or Windows XP operating system. The system must contain an Intel RAID controller.

1. Boot to the Windows operating system. The Found New Hardware Wizard is displayed. The information on the first page of this window identifies the SAS controller and requests the driver diskette.
2. Insert the Windows driver diskette into the floppy drive.
3. For Windows 2003 or Windows XP, choose **Install Software Automatically**. In Windows 2000, choose **Search for a Suitable Driver**.
4. Windows 2000 only: Click the Specify location box and make sure the search location is the floppy drive.
5. Click **Next**.
6. A message might display saying that this driver is not digitally signed. This message informs you that a nonsigned driver is being installed. If you see this message, click **Continue Anyway**.
7. The system loads the driver from the Windows driver diskette and copies the driver to the system disk. The Found New Hardware Wizard screen displays the message:
`The wizard has finished...`
8. Click **Finish** to complete the driver upgrade.

RAID Driver Installation for Red Hat* Enterprise Linux

This section describes the installation of the device driver on new Red Hat* Enterprise Linux 3.0 or 4.0 systems. See the release notes that accompanied the driver for information on updating the Red Hat Linux driver on an existing Red Hat Linux system.

1. Boot to the CD-ROM with Disk 1. Type:
`linux dd`
2. Press <Enter> at the boot prompt on the Welcome screen.
3. Copy the Linux driver image from the *Resource CD* to a diskette or USB key.
4. Insert the diskette with driver image.
5. Select **Yes**.
6. Scroll down to select Intel RAID adapter driver. The utility locates and loads the driver for your device.
7. Follow the Red Hat Linux installation procedure to complete the installation.

RAID Driver Installation for SuSE* Linux

SuSE* Linux uses a program called YaST2 (Yet another System Tool) to configure the operating system during installation. For complex installations, you can select “Install Manually” at the first install screen and a different program, `linuxrc`, will be used. This section assumes a straightforward installation using YaST2.

1. Insert CD-ROM disk 1 into the CD-ROM drive and the RAID controller driver diskette in the floppy drive.
1. Boot to the CD.
2. The operating system loads a minimal operating system from the CD onto a RAM disk. Any driver module found in the floppy drive will also be loaded.
3. At the Welcome to YaST2 screen, select your language and click **Accept**.
4. At the “Installation Settings” screen, setup the disk partitioning.
5. Continue with the SuSE Linux installation procedure.

3 Intel® Embedded Server RAID BIOS Configuration Utility

If the SATA RAID or SAS RAID options are enabled in the server BIOS, an option to enter the Intel® Embedded Server RAID BIOS Configuration utility displays during the server boot process. To enter the utility, press the <Ctrl> + <E> when prompted.

The Intel® Embedded Server RAID BIOS Configuration utility allows a user to:

- Create, add, modify, and clear logical drive configurations
- Initialize or rebuild the configured drives
- Set the boot drive
- Create a global hotspare drive
- View physical and logical drive parameters
- View and set adapter properties, including consistency check and auto-resume

SATA and SAS systems use different versions of the Intel® Embedded Server RAID BIOS Configuration utility, but both versions use the same keystrokes and contain identical menus. The utility menus show limited help at the bottom of the screen and selections are chosen with the arrow keys and the space bar. A warning is displayed if there is no logical drive is available to be configured. Only the number of potential physical drives differs for the SAS and SATA versions of the utility.

The following menu and sub-menu options are available:

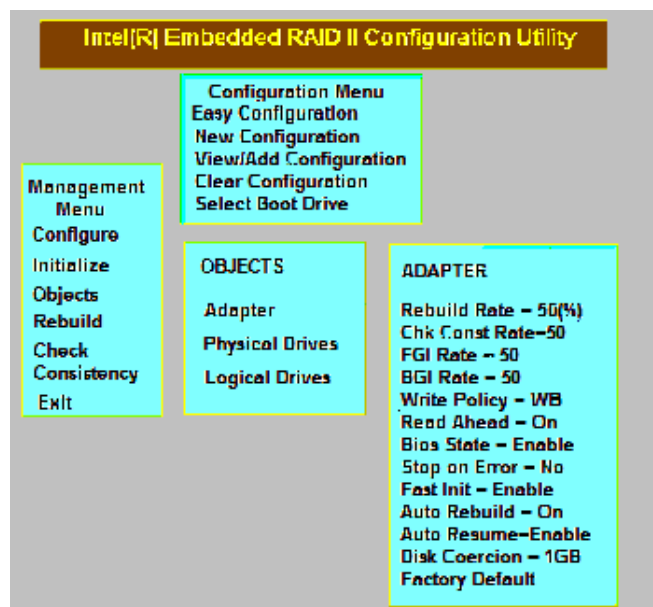

Figure 6. Intel® Embedded Server RAID BIOS Configuration Utility Screen

Creating, Adding or Modifying a Logical Drive Configuration

Use the following steps to create, add, or modify a logical drive configuration.

1. Boot the system.
2. Press <Ctrl> + <E> when prompted to start the Intel[®] Embedded Server RAID BIOS Configuration utility.
3. Select **Configure** from the Main Menu.
4. Select a configuration method:
 - **Easy Configuration** does not change existing configurations, but allows new configurations.
 - **New Configuration** deletes any existing arrays and logical drives and creates only new configurations.
 - **View/Add Configuration** lets you view or modify an existing configuration.

For each configuration method, a list of available physical drives is displayed. These drives are in the READY state. Information about each drive is displayed if you select it.
5. Use the arrow keys to move to a drive and press the space bar to add it to the array.

Note: The utility limits each drive to the size of the smallest drive.

The status for each selected drive that is added to an array changes status from READY to ONLIN A[array#]-[drive#]. For example, ONLIN A00-01 means array 0, disk drive 1.

6. (Optional) Create a global hotspare drive by highlighting a drive that is marked READY and press the <F4> key. Then select **Yes** from the pop-up menu.
7. Repeat step 5 and step 6 to create a second array if desired. When you have selected drives for all desired arrays, press the <F10> key.
8. Select an array by highlighting it. Press the <Enter> key to set the properties.
9. The logical drive configuration screen is displayed, This screen shows the
 - Logical drive number
 - RAID level
 - Logical drive size
 - Number of stripes in the physical array
 - Stripe size
 - State of the logical drive

To set these options, highlight a property and press the <Enter> key. The available parameters for that property are displayed for the selection.
10. Select a RAID level: Select 0, 1, or 10 depending upon number of drives and the purpose.
11. Consider whether you need to override the default logical drive size. By default, all available space in the array is assigned to the current logical drive. For RAID 10 arrays, only one logical drive can be defined for the entire array.

12. (Optional) Change the default Write Cache and Read Ahead policies. See Setting the Write Cache and Read Ahead Policies.
13. When you have finished defining the current logical drive, select **Accept** and press the <Enter> key.
14. Repeat step 8 through step 13 for all logical drives.
15. Save the configuration when prompted, and press any key to return to the Main Menu.
16. Select **Initialize** and use the space bar to highlight the logical drive to initialize.

Caution: *All data on the logical drive will be erased during an initialization.*

17. Press the <F10> key. Select **Yes** at the prompt and press the <Enter> key to begin the initialization. A graph shows the progress of the initialization.
18. After the initialization is complete, press the <Esc> key to return to the previous menu. Pressing the <Esc> key closes the current menu. If a process is running when you press the <Esc> key, you will be given the following options:
 - **Abort:** When Abort is selected, the task is stopped and will not resume. Abort does not restore data if an initialization had been started.
 - **Stop:** When Stop is selected, the current task stops. Stop is available only if auto resume is enabled on the adapter. See AutoResume / AutoRestore for information.
 - **Continue:** The task continues normally. Continue cancels the press of the <Esc> key. If AutoResume is enabled, the task will resume from point at which it was stopped.

Setting the Write Cache and Read Ahead Policies

Read and write cache settings apply to all logical drives in an array. They may show as on/off; enable/disable; or as initials of the desired state, such as WB for Write Back. They appear in menus as Write Policy and Read Policy or as Write Cache and Read Ahead. These policies can be seen from the Adapter Properties or from the Logical Drive's View/Update Parameters.

The following are the cache policies:

- If WC is on, or if Write Policy is WB, Write Back is enabled. In this mode, the data transfer is signaled as complete when the controller cache has received all the data.

Caution: *Write Back mode will lose data if power fails before the cached data is written to the drive.*

- If WC is off, Write Through is enabled. The data transfer is complete when the drive has received all the data.
- RA = ON allows the controller to read additional data and store that data into its cache. This improves performance on sequential reads.

To change cache policies:

1. Select **Objects** | **Logical Drive** | **Logical Drive n** | **View/Update Parameters**.
2. Use the arrow key to select the option to change. Press the <Enter> key.
3. Use the arrow key to select **Off** or **On**.
4. Confirm the choice by using the arrow key to select **Yes** if asked to confirm the change. Press the <Enter> key to change the cache setting.

Working with a Global Hotspare Drive

A global, but not dedicated, hotspare drive can be created to automatically replace a failed drive in a RAID 1 or RAID 10 array. For new arrays, the global hotspare should be created during the configuration process. See [“Creating, Adding or Modifying a Logical Drive Configuration,”](#) on page 16.

Adding a Hot Spare Drive

To add a hot spare drive to an existing configuration, follow these steps:

1. Select **Objects** from the Main Menu.
2. Select **Physical Drive**. A list of physical drives is displayed.
3. Select an unused drive from the list, and select **Make Hot Spare**. The screen changes to indicate HOTSP.

Removing a Hot Spare Drive

To remove a hotspare drive:

1. Select **Objects** from the Main Menu.
2. Select **Physical Drive**. A list of physical drives is displayed.
3. Select the disk that displays **HOTSP**, press the <Enter> key.
4. Select **Force Offline** and press the <Enter> key. The status of the drive changes to **READY**. The drive can be used in another array.

Rebuilding a Drive

The Intel® Embedded Server RAID BIOS Configuration utility includes a manual rebuild option that rebuilds an individual failed drive in a RAID 1 or 10 array. RAID 0 drives are not redundant and cannot be rebuilt. A good drive (not physically failed) can also be rebuilt using the existing configuration data.

To rebuild a drive:

1. Select **Rebuild** from the Main Menu. The failed drives show the status FAIL.
2. Press the arrow keys to highlight the physical drive that you want to rebuild. Press the space bar to select the drive.
3. Press the <F10> key and select **Y** to confirm. The drive indicator shows REBLD as the rebuild process starts.
4. When the rebuild is complete, press any key to continue.

Auto Rebuild and Auto Resume

To ensure data protection, enable Auto Rebuild and Auto Resume so that drives are automatically re-created to maintain redundancy.

- In a pre-boot environment, auto rebuild starts only when you enter the BIOS utility.

Note: Hot plug support is not available in the pre-boot environment. For the system BIOS or the Intel® Embedded Server RAID BIOS Configuration utility to detect the physical drive, insert the drive when the system is off.

- When the operating system is running, the auto rebuild starts if the system has a hotspare drive or if you replace the failed drive with a new drive.

The Auto Rebuild and Auto Resume options are available in the Intel® Embedded Server RAID BIOS Configuration utility from the menu that is displayed after you select **Objects | Adapter**.

Checking Data Consistency

The Check Consistency feature can be used on RAID 1 or RAID 10 drives to verify the data consistency between the mirrored drives. It can be set to only report or to both report and automatically fix the data.

1. From the Main Menu, select **Check Consistency** and press the <Enter> key. A list of configured logical drives is displayed.
2. Use the arrow keys to choose the desired drive. Press the space bar to select the logical drive to check for consistency. (RAID 1 or 10 only)
3. Press the <F10> key.
4. At the prompt, select **Yes** and then press the <Enter> key.

If the Report and Fix/Report options are not shown, select **Main Menu | Objects | Adapter | ChkCons** and set **Report only** or **Fix/Report**.

Viewing and Changing Device Properties

The properties of adapters, logical drives, and physical drives can be viewed. Some adapter properties and the Write Cache and Read Ahead for Logical Drives can be changed.

1. From the Main Menu select **Objects**
2. Choose **Adapter**, **Logical Drive**, or **Physical Drive**.
3. Select the device from the list and view the properties.
 - For logical drives choose **View | Update Parameters**.
 - For physical drives choose **Drive Properties**.

The numeric values of the rates settings are the percentage of system resources. FGI and BGI are abbreviations for foreground and background initialization rates.

4. To change a value, highlight the property and press the <Enter> key.

Note: Some values cannot be changed.

5. Select or type a different value for the property and press the <Enter> key.
6. When you are finished, press the <Esc> key until you return to the Main Menu.

Forcing Drives Online or Offline

A drive can be forced offline so that a hot spare drive will replace it. Power failures may cause a drive to go offline and you must force it back online.

Forcing a Drive Online or Offline

To force a drive online or offline, follow these steps:

1. On the Main Menu, select **Objects** and then **Physical Drive**.
2. Highlight a physical drive that is a member of an array and press the <Enter> key.
3. From the menu, choose one of the following:
 - Force Offline to take the drive off line. If the drive was online, its status changes to FAIL.
 - Force Online to bring the drive on line. If the drive was offline, its status changes to ONLIN.

Configuring a Bootable Logical Drive

Follow these steps to configure a bootable logical drive:

1. From the Main Menu, select **Configure | Select Boot Drive**.
2. Select a logical drive from the list to be the designated boot drive.

Note: You should also check the system BIOS Setup utility for the boot order setting. To access the BIOS Setup utility, press the <F2> key when prompted during POST.

Deleting (Clearing) a Storage Configuration

***Caution:** Before you clear a storage configuration, back up all the data you want to keep.*

To clear a storage configuration, follow these steps:

1. On the Main Menu, select **Configure | Clear Configuration**.
2. When the message appears, select **Yes** to confirm. All logical drives are deleted from the configuration.

4 Intel® RAID BIOS Console 2 Utility

The Intel® BIOS Console 2 utility provides a GUI utility to configure and manage RAID volumes. The utility configures disk arrays, disk groups, and logical drives. Because the utility resides in the RAID controller firmware, it is independent of the operating system.

The BIOS Console 2 utility:

- Selects adapters
- Displays adapter properties
- Scans devices
- Displays the physical properties of devices
- Configures physical drives
- Defines logical drives
- Displays logical drive properties
- Initializes logical drives
- Checks data for consistency

The Intel® BIOS Console 2 utility provides a Configuration Wizard to guide you through the configuration of logical drives and physical arrays.

Quick Configuration Steps

This section provides the steps to configure arrays and disk groups, and logical drives using the Intel® BIOS Console 2 utility. The following sections describe how to perform each action using the BIOS Console 2 utility. The steps are:

1. Power on the system.
2. Press <Ctrl>+<G> to start the Intel® BIOS Console 2 utility.
3. Start the Configuration Wizard.
4. Choose a configuration method.
5. Create arrays and disk groups using the available physical drives.
6. Define the logical drive(s) using the space in the arrays and disk groups.
7. Initialize the new logical drives.

Detailed Configuration Steps using the Intel® RAID BIOS Console 2

Start the BIOS Console 2 Utility

1. When the system boots, hold down the <Ctrl> key and press the <G> key when the following is displayed:
Press <Ctrl>+<G> for BIOS Console 2
2. After you press <Ctrl>+<G>, the Adapter Selection screen displays. Select an adapter and click **Start** to begin the configuration.

Note: If there is a configuration mismatch between the disks and the NVRAM, the utility automatically displays the Select Configuration screen. Choose whether the configuration should be read from the RAID array or from NVRAM. For more information, see the subsection entitled “Configuration Mismatch Screen” on page 30.









Screen and Option Descriptions

This section describes the BIOS Console 2 screens and options.

Toolbar Options

Table 1 describes the BIOS Console 2 toolbar icons.

Table 1. Intel® RAID BIOS Console 2 Toolbar Icon Descriptions

Icon	Description	Icon	Description
	Return to the main screen.		Scan for adapters connected to your system.
	Return to the page you accessed immediately before the current page.		Display the properties of the adapter, such as the firmware version, BIOS version, RAM size, and initiator ID.
	Exit the BIOS Console 2 utility.		Configure the arrays and disk groups, and logical drives.v
	Display the adapters that you can select.		Silence the alarm.

Main Screen

From the main screen you can scan the devices connected to the controller, select an Intel® RAID adapter, and switch between the physical drives view and logical drive view. The main screen also provides access to the screens and tools:

- Adapter Properties
- Scan Devices
- Physical Drives
- Logical Drive
- Configuration Wizard
- Events
- Exit

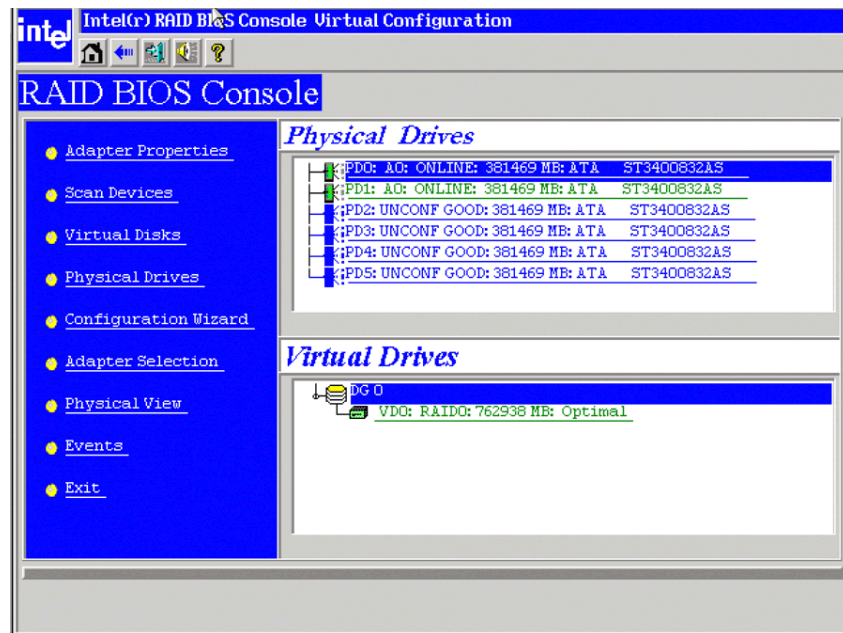

Figure 7. Intel® RAID BIOS Console 2 Menu

Adapter Properties Screen

When you select the Adapter Selection option on the main screen, the Intel® BIOS Console 2 utility displays a list of the Intel RAID adapters in the system.

The Adapter Properties screen allows you to view and configure the software and hardware of the selected adapter.

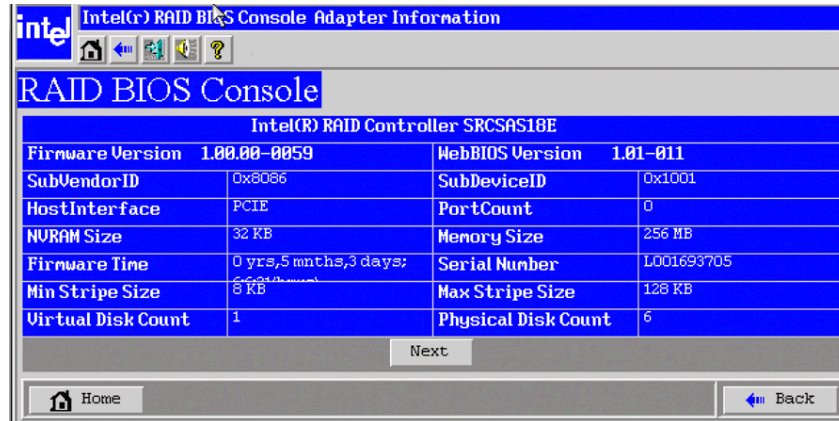

Figure 8. Adapter Properties

- **Firmware Version:** The firmware version.
- **Host Interface:** The host interface for the installed RAID controller.
- **NVRAM Size:** The NVRAM size on the RAID controller.
- **Firmware Time:** The current time.
- **Min Stripe Size:** The minimum stripe size used to read and write data.
- **BIOS Console 2 Version:** The BIOS version for the BIOS Console 2.
- **Sub Device ID:** The sub-device ID for the RAID controller.
- **Port Count:** Number of ports available.
- **Memory Size:** The memory size of the installed DIMM.
- **Max Stripe Size:** The maximum stripe size.
- **Physical Disk Count:** The number of physical disks connected to the RAID controller.

Additional Adapter Properties

To access the screen that displays the additional adapter properties, click **Next** from the Adapter Properties screen. To change one of the properties displayed in the screen below, select the new entry and click **Submit**.

Properties			
Battery Backup	Present	Coercion Mode	1GB-way
Set Factory Defaults	No	PDF Interval	300
Cluster Mode	Disabled	Alarm Control	Enabled
Rebuild Rate	30	Int Throttle Cnt	16
Patrol Read Rate	30	Int Throttle Time	50
BGI Rate	30	Cache Flush Interval	4
CC Rate	30	Spinup Drive Count	2
Reconstruction Rate	30	Spinup Delay	6
Adapter BIOS	Enabled		

Figure 9. Additional Adapter Properties

- **Battery Backup:** Indicates if a battery backup unit is installed.
- **Set Factory Defaults:** Changing this field to **Yes** resets the RAID controller settings to the factory defaults.
- **Cluster Mode:** Enable this field if the RAID controller is used in a cluster.
- **Rebuild Rate:** Enter a number between 0 and 100 to control the rate at which a future rebuild will be performed on a disk array or disk group.
- **Patrol Read Rate:** A patrol read is a preventive procedure that monitors physical disks to locate and resolve potential problems that could lead to disk failure. Enter a number between 0 and 100 to control the rate at which patrol reads will be performed.
- **BGI Rate (Background Initialization Rate):** Background initialization makes the logical drive immediately available for use, even while initialization is occurring. Enter a number between 0 and 100 to control the rate at which logical drives are initialized in the background.
- **CC Rate (Check Consistency Rate):** A consistency check scans the consistency of data on a fault-tolerant disk to determine if the data has become corrupted. Enter a number between 0 and 100 to control the rate at which a consistency check is done.
- **Reconstruction Rate:** Enter a number between 0 and 100 to control the rate at which the reconstruction of a logical drive occurs.
- **Adapter BIOS:** Determines whether the Option ROM is loaded.

- **Coercion Mode:**
 - None: No coercion of size.
 - 128M: The software rounds the drive capacity down to the next 128 MB boundary and then up to the nearest 10 MB until the coerced capacity is larger than the actual drive size. It is then reduced by 10 MB.
 - 1G: The software rounds the drive capacity down to the nearest 1 GB boundary and then down by 1 MB. This corresponds to the terms most drive manufacturers use.
- **PDF Interval:** The PDF interval is the predictive disk failure polling interval. This is the time needed between disk polls to perform SMART polling.
- **Alarm Control:** Disable the alarm to turn off the onboard speaker alarm.
- **Interrupt Throttle Count** and **Interrupt Throttle Time:** Sets the interrupt throttle and count times. This is the number of times that interrupts are coalesced and the amount of time that firmware holds an interrupt before passing it to the host software. Set values lower for better performance, but be aware that latency is impacted by these settings.
- **Cache Flush Interval:** This sets the cache flush interval. Valid settings are 2, 4, 6, 8, or 10 seconds.
- **Spinup Drive Count:** This setting controls the number of drives that spin up at one time.
- **Spinup Delay:** After the RAID controller completes its initialization process, the initial delay value defines the number of seconds before the first disk interrogation request is issued to the array or disk group. This value should not be changed.

Scan Devices Option

When you select the Scan Devices option on the Main screen, the BIOS Console 2 checks the physical and logical drives for any changes of the drive status. The BIOS Console 2 displays the results of the scan in the physical and logical drive descriptions.

Logical Drives Screen

You can access the logical drives screen by clicking on a logical drive in the logical drive list on the main screen. The upper right section of the screen displays the logical drives that currently exist. The Logical Drives screen provides options to:

- **Initialize the logical drives:** The Slow Initialize option initializes the selected logical drive by writing zeroes to the entire volume. You should initialize each new logical drive that you configure.

Warning: Initializing a logical drive deletes all information on the physical drives that compose the logical drive.

- **Check consistency (CC):** This option verifies the correctness of the redundancy data and is available for arrays and disk groups using RAID 1, 5, 10, or 50. If a difference in the data is found, the BIOS Console 2 assumes that the data is accurate and automatically corrects the parity value.

- Display the logical drive properties: Through the Properties option you can:
 - Display the logical drive properties (such as RAID level, logical drive size, and stripe size).
 - Display the read, write, Access, Disk Cache, BGI, and I/O policies.
 - Change the read, write, Access, Disk Cache, BGI, and I/O policies.
 - Start initialization.
 - Start a consistency check.

After setting any property, click **Go** to perform the selected operation. Click **Change** to apply any policy changes.

Physical Drives Screen

This screen displays the physical drives for each channel or port. From this screen, you can rebuild the physical arrays or disk groups, or view the properties for the physical drive you select. Click **Reset** to return to the configuration that existed before you made any changes. Select Properties and click **Go** to view the properties. An unconfigured drive can be made into a hot spare from the Properties screen.

Configuration Wizard Option

This option enables you to clear a configuration, create a new configuration, or add a configuration. "Configuration Wizard," on page 30 provides detailed steps for using the Configuration Wizard.

Adapter Selection

This option allows you to choose an Intel[®] RAID controller installed in the system.

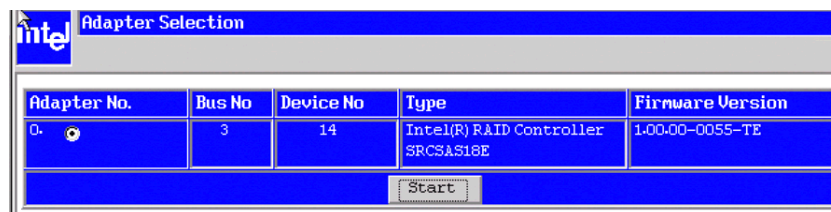

Figure 10. BIOS Console 2 - Adapter Selection

Events Screen

This option displays the events generated by logical drives, physical devices, enclosure, the Intel[®] Smart Battery, and SAS controller. See Appendix B: "Events and Messages" for events and message descriptions.

Physical View/Logical View Option

This option toggles between Physical View and Logical View.

Exit

This option allows you to exit and reboot the system.

Configuration Mismatch Screen

A configuration mismatch occurs when the data in the NVRAM and the hard disk drives are different. It will be automatically displayed after POST when a configuration mismatch occurs. The Configuration Mismatch screen allows you to:

- Select **Create New Configuration** to delete the previous configuration and create a new configuration.
- Select **View Disk Configuration** to restore the configuration from the hard disk.
- Select **View NVRAM Configuration** to restore the configuration from the NVRAM.

Configuration Wizard

This section provides detailed steps for using the Configuration Wizard to set up a RAID array.

1. Start the Configuration Wizard by selecting the **Configuration Wizard** icon on the BIOS Console 2 main screen.

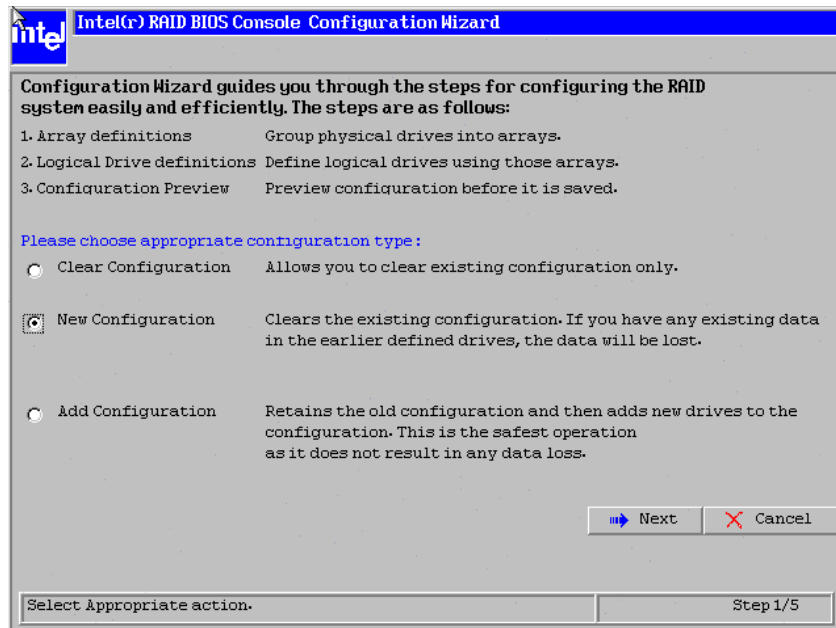

Figure 11. BIOS Console 2 - Configuration Types

2. Select **New Configuration** and click Next.

3. Choose the configuration method and click Next.

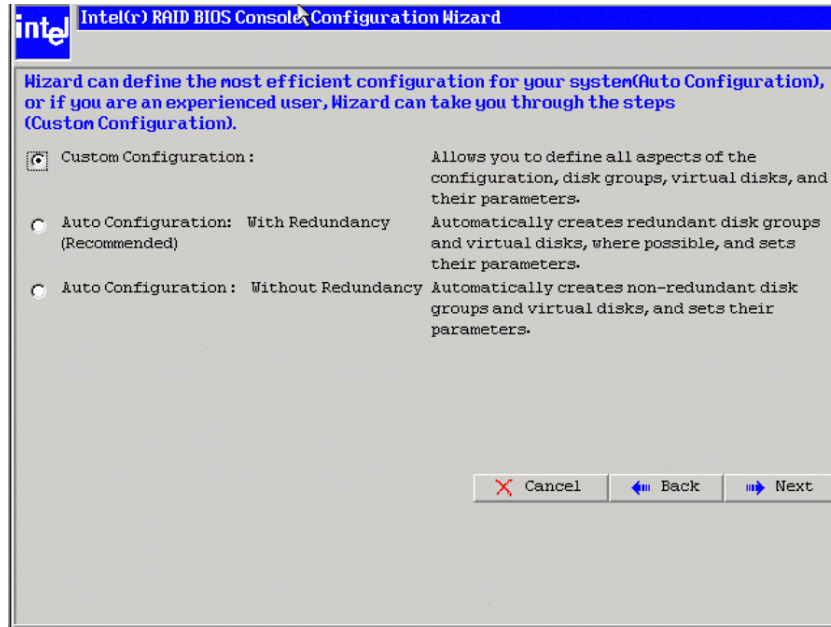

Figure 12. BIOS Console 2 - Configuration Methods

The configuration methods options are described below.

- Auto Configuration with Redundancy

This option configures RAID 1 for systems with two drives or RAID 5 for systems with three or more drives. All available physical drives will be included in the logical drive using all available capacity on the disks.

Note: Hot spare drives must be designated before starting auto configuration using all available capacity on the disks.

- Auto Configuration without Redundancy

Configures all available drives as a RAID 0 logical drive.

- Custom Configuration

Allows you to configure the RAID mode.

Note: Auto Configuration cannot be used for RAID 10 or 50 or with mixed SATA and SAS drives.

Creating RAID 0, 1, or 5 through the RAID BIOS Console 2 (detailed)

This section describes the process use the custom configuration options to set up RAID modes.

1. When the server boots, hold the <Ctrl> key and press the <G> key when the following is displayed:
Press <Ctrl>+<G> for BIOS Console
The Adapter Selection screen is displayed.
2. Select an adapter and click Start to begin the configuration.
3. Choose Custom Configuration and click **Next**.
4. At the Virtual Drive Definition (VD Definition) screen, hold down the <Ctrl> key and click each drive you want included in the array or disk group. See "Levels of RAID," on page 4 for the required minimum number of drives that must be added.

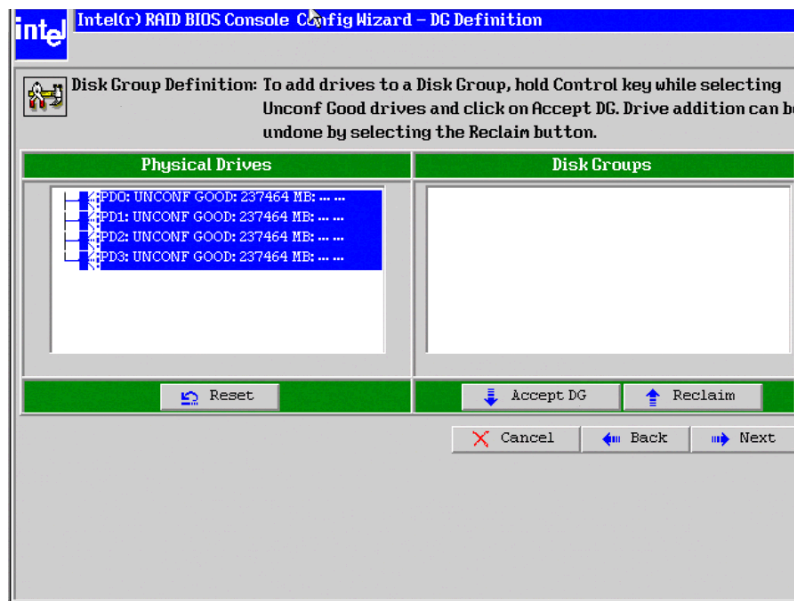

Figure 13. BIOS Console 2 - Add Physical Drives to Array

5. Click **Accept DG**. If you make a mistake and need to remove drives, click **Reclaim**. Click **Next**.

6. On the VD Definition window, select RAID 0, 1, or 5 from the first dropdown box.
7. Enter the logical drive size in the **Select Size** box. This example shows 712392, but the size may be edited.
8. If desired, change the Stripe Size, the policies for Access, Read, Write, IO, and Disk Cache and decide whether to use background initialization. See ["Setting Drive Parameters,"](#) on page 41.

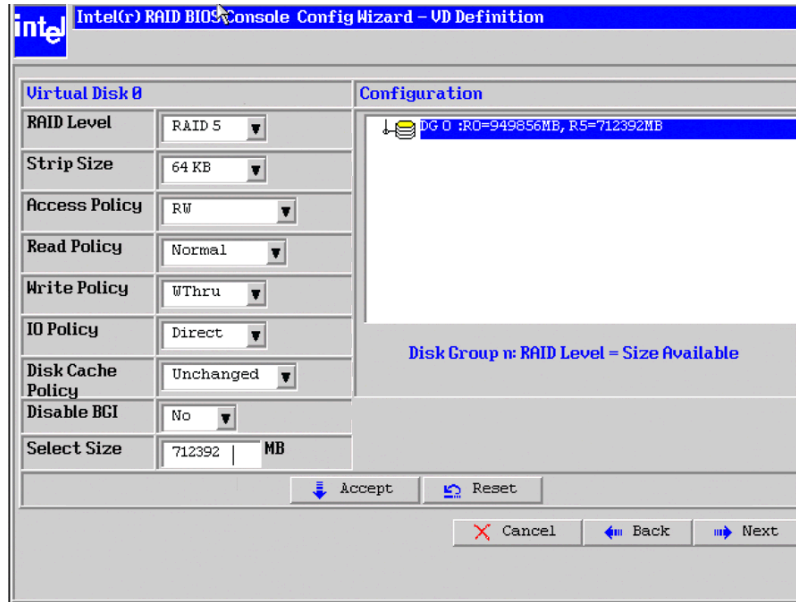

Figure 14. BIOS Console 2 - Set Array Properties

9. Click **Accept** to accept the changes, or click **Reset** to delete the changes and return to the previous settings.

10. The BIOS Console 2 configuration utility displays a preview of the configuration. Click **Accept** to save the configuration, or click **Back** to return to the previous screens and change the configuration.

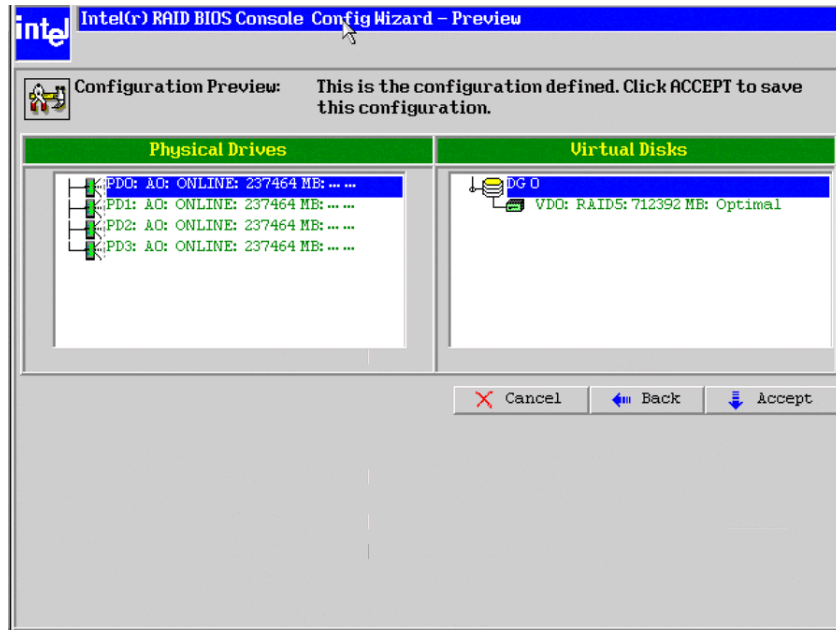

Figure 15. BIOS Console 2 - Confirm Configuration

11. Click **Next** and then **Accept** to complete the selection.
12. Click **Accept** to accept the configuration. You are prompted to save the configuration and then to initialize the logical drive.

13. Click **Yes** to initialize the new drive.
14. Click Initialize to begin the initialization process.
 - Fast initialization runs a quick preliminary initialization and then runs full initialization in the background after the operating system is booted.
 - Slow initialization may take several hours to complete.

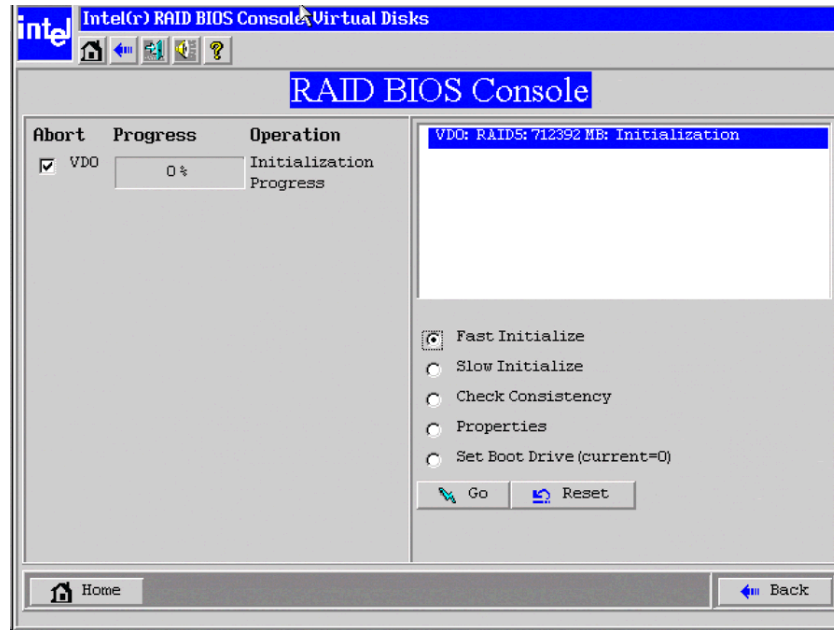

Figure 16. BIOS Console 2 - Initialization Speed Setting

15. Click **Home** to return to the main configuration screen. Select an additional logical drive to configure or exit the BIOS Console 2 configuration utility and reboot the system.

RAID 10 and RAID 50 Creation Using BIOS Console 2

RAID 10 and RAID 50 require setting up multiple RAID arrays / disk groups.

1. When the server boots, hold the <Ctrl> key and press the <G> key when the following is displayed:
Press <Ctrl>+<G> for BIOS Console
2. After you press <Ctrl>+<G>, the Adapter Selection screen displays. Select an adapter and click **Start** to begin the configuration.
3. Select **Custom Configuration** and click **Next**.
4. At the Virtual Drive Definition (VD Definition) screen, hold down the <Ctrl> key and click each drive you want included in the first array.
 - For RAID 10, use two drives
 - For RAID 50, use at least three drives
5. Click **Accept DG**. The first group of drives appears as a disk group in the right pane. These drives are no longer available in the left pane.
6. From the drives that are available in the left pane, choose an additional group of drives and again click **Accept DG**. Each disk group must contain the identical quantity and size of drives.
7. Multiple drive groups are now displayed in the right pane. Up to eight arrays can be added to the right pane for either RAID 10 or RAID 50.

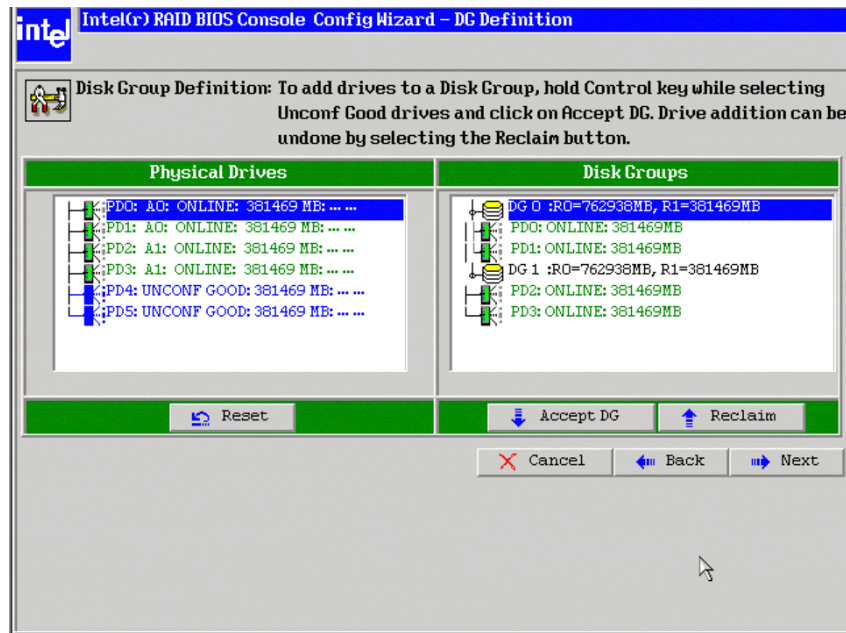

Figure 17. RAID BIOS Console 2 Utility – Multiple Disk Groups for RAID 10 or 50

8. Select all arrays or disk groups that are to be spanned in the RAID 10 or 50 array by holding down the <Ctrl> key and selecting each array/disk group in the right pane. Click **Next**.

9. At the Virtual Drive Definition (VD Definition) window, select RAID 1 (for RAID 10) or RAID 5 (for RAID 50) in the RAID Level drop-down. RAID 10 is illustrated below.
10. Select the appropriate Stripe Size, Access Policy, Read Policy, Write Policy, IO Policy, Disk Cache Policy, and Enable/Disable BGI for your application. See ”,” on page 40 for information about these parameters.
11. Set the drive size to a number in MB that is a size greater then the size of the RAID 1 or RAID 5 size listed in the disk group.

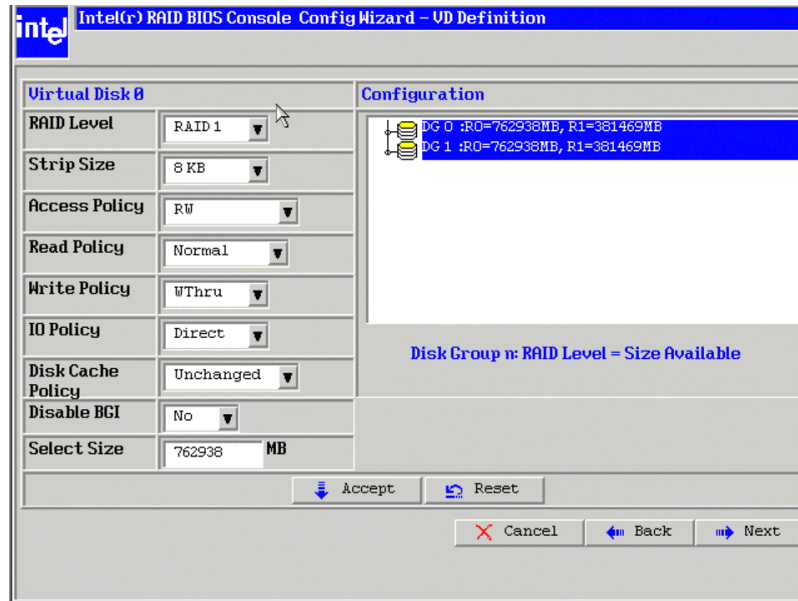

Figure 18. RAID BIOS Console 2 – Spanning Multiple Arrays

12. Click **Next** if the application does not automatically progress to the next screen.

The configuration preview screen displays the logical drive as shown below. The configuration preview screen displays the logical drive (RAID 1 for RAID 10, or RAID 5 for RAID 50).

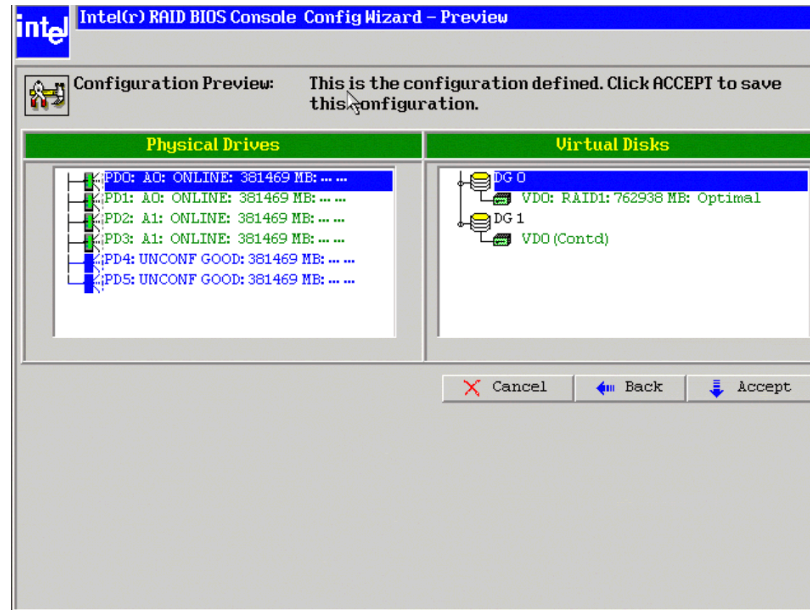

Figure 19. RAID BIOS Console 2 – Viewing Completed Settings

13. Click **Accept** to save the configuration.
14. Click **Yes** when asked to save the configuration. This will store the configuration in the RAID controller.
15. Click **Yes** when asked to initialize the drive.

16. Select **Fast Initialize**. Click **Go**. The drives will initialize based on the RAID settings.

Note: Slow Initialize initializes the entire drive and may take several hours to complete.

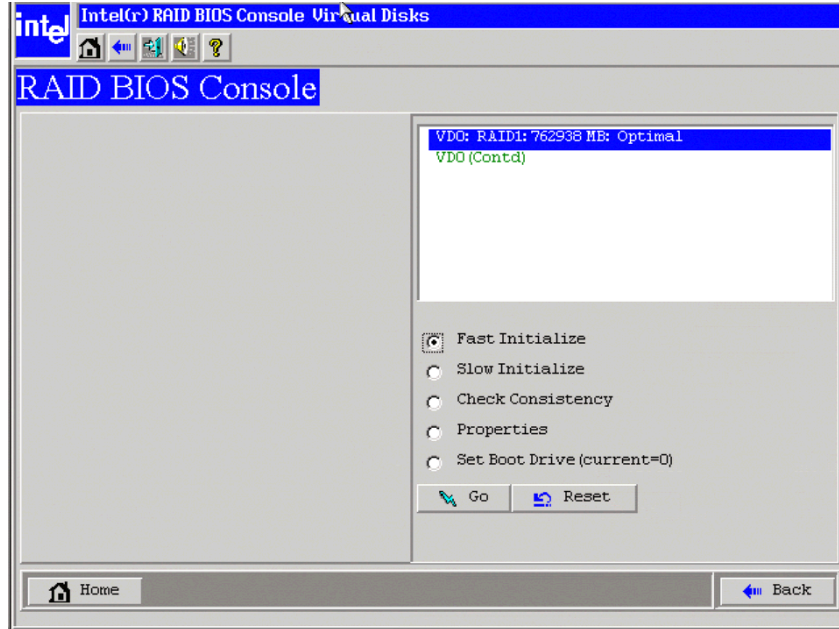

Figure 20. RAID BIOS Console 2 – Initialization Settings

17. Click **Home** at the BIOS Console 2 screen to return to the main screen. The RAID 10 or RAID 50 logical drives are displayed. The figure below shows the RAID 10 logical drives.

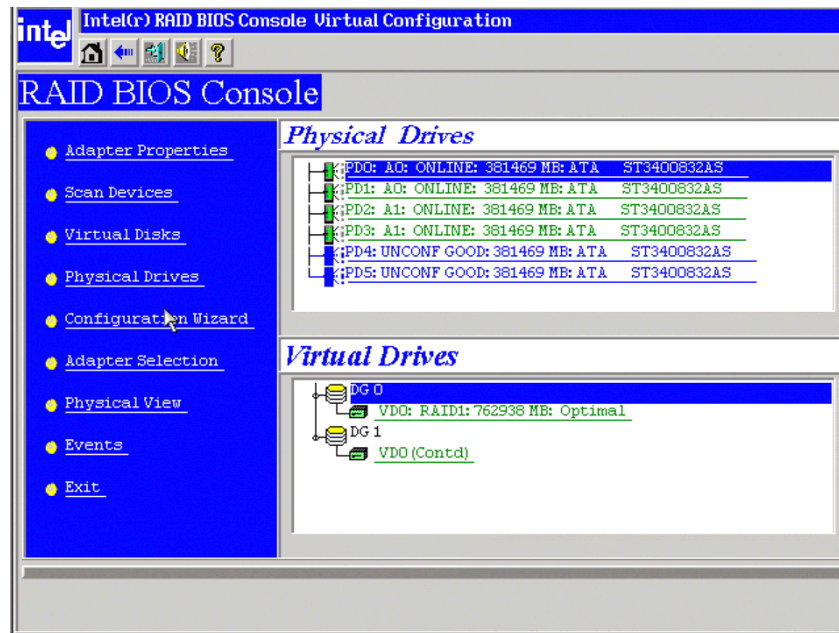

Figure 21. RAID BIOS Console 2 – RAID 10 Final Screen

18. Under Virtual Drives, select **VD0: RAID1** for RAID 10, or select **VD0:RAID 5** for RAID 50 to display the drive properties. The properties display as RAID 10 or RAID 50.

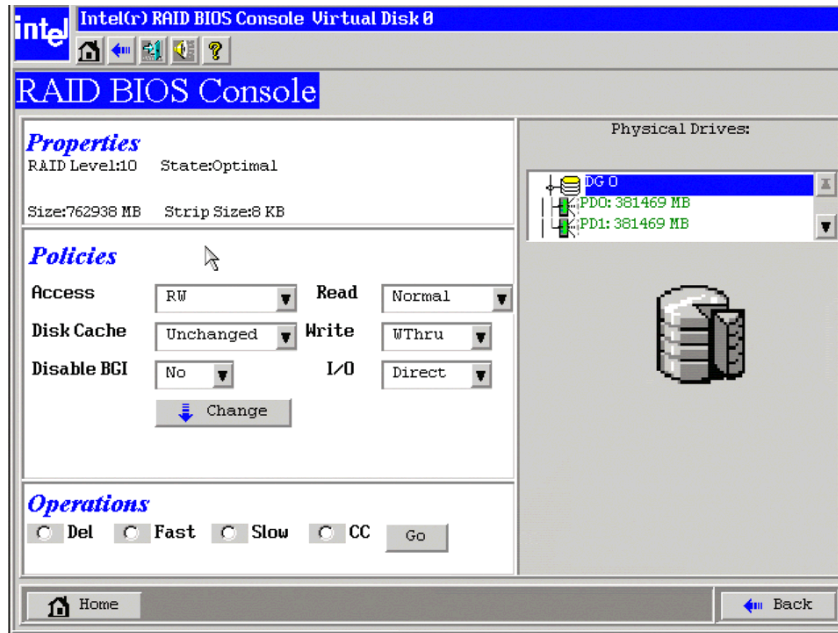

Figure 22. RAID BIOS Console 2 – RAID 10 Properties Screen

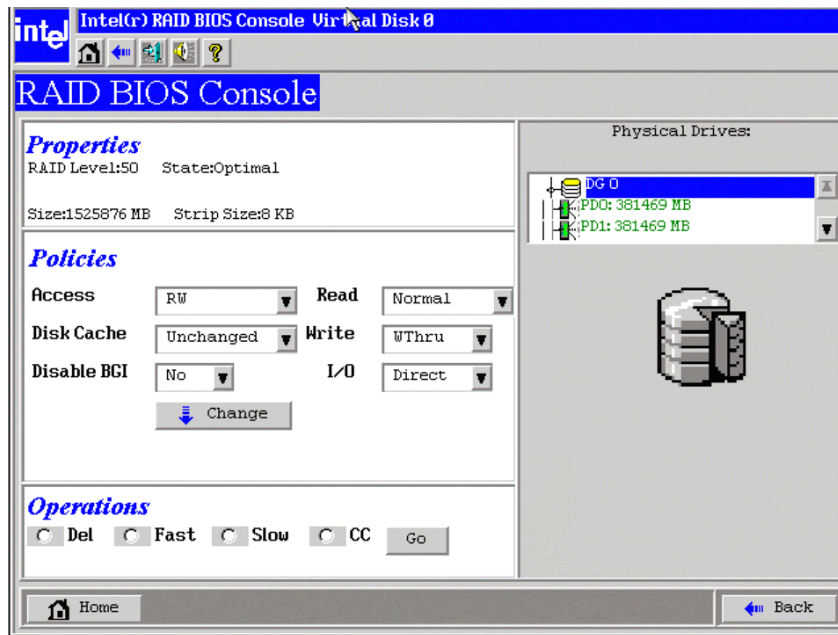

Figure 23. RAID BIOS Console 2 – RAID 50 Properties Screen

Setting Drive Parameters

- **RAID Level:**
 - RAID Level 0: Data striping
 - RAID Level 1: Data mirroring
 - RAID Level 5: Data striping with parity
 - RAID level 10: Striped mirroring
 - RAID Level 50: Striped RAID 5
- **Stripe Size:** Specify the size of the segment written to each disk. Available stripe sizes are 4, 8, 16, 32, 64, or 128 Kbytes. The default is 64 Kbytes.
- **Access Policy:** Select the type of data access that is allowed for this logical drive. The choices are Read/Write, Read Only, or Blocked.
- **Read Policy:** Enables the read-ahead feature for the logical drive. Read-ahead is the default setting.
 - Normal: The controller does not use read-ahead for the current logical drive.
 - Read-ahead: Additional consecutive stripes are read and buffered into cache. This option will improve performance for sequential reads.
 - Adaptive: The controller begins using read-ahead if the two most recent disk accesses occurred in sequential sectors.
- **Write Policy:** Determines when the transfer complete signal is sent to the host. Write-through caching is the default setting.
 - Write-back caching: The controller sends a data transfer completion signal to the host when the controller cache receives all of the data in a transaction. Write-back caching has a performance advantage over write-through caching, but it should only be enabled when the optional battery backup module is installed.
 - Write-through caching: The controller sends a data transfer completion signal to the host after the disk subsystem receives all the data in a transaction. Write-through caching has a data security advantage over write-back caching.

Caution: Do not use write-back caching for any logical drive in a Novell NetWare* volume.*

- **IO Policy:** Applies to reads on a specific logical drive. It does not affect the read-ahead cache.
 - Cached IO: All reads are buffered in cache memory.
 - Direct IO: Reads are not buffered in cache memory. Data is transferred to cache and to the host concurrently. If the same data block is read again, it comes from cache memory.
- **Disk Cache Policy:** The cache policy applies to the I/O on a specific logical drive. It does not affect the read-ahead cache.
 - Cached I/O: Buffers all reads in cache memory.
 - Direct I/O: Does not buffer reads in cache memory. When possible, Direct I/O does not override the cache policy settings. Direct I/O transfers data to cache and the host concurrently. If the same data block is read again, the host reads it from cache memory. The choices are Unchanged, Enabled, or Disabled.

- **Disable BGI:** Enable or disable background initialization. Set this to “Yes” to disable background initialization.
- **Select Size:** Set the size of the logical drive in megabytes. The right pane of the logical drive configuration window lists the maximum capacity that can be selected, depending on the RAID level chosen.

Creating a Hot Spare

1. In the main screen, select the drive that should be used as the hot spare.

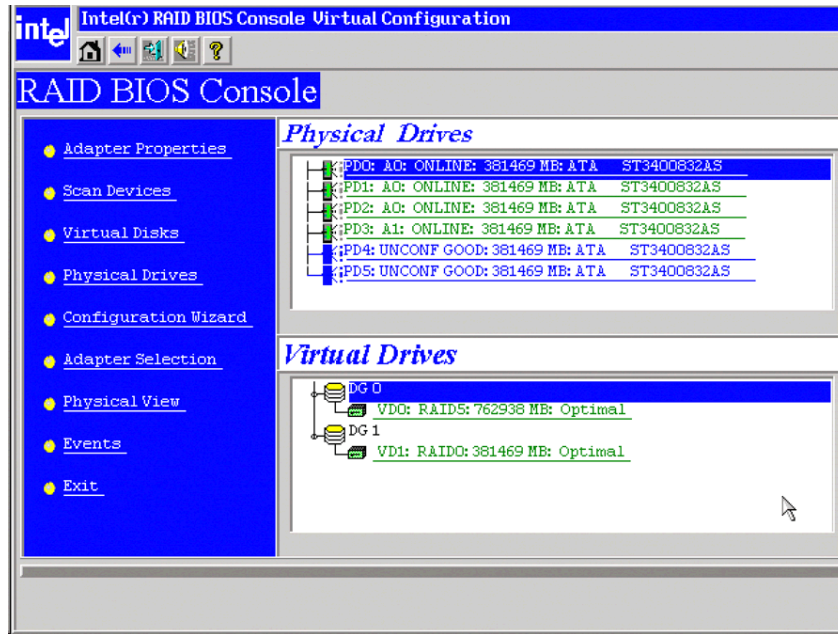

Figure 24. RAID BIOS Console 2 – Choosing a Hot Spare Drive

2. Select the disk group.

3. Click **Make Dedicated Hot Spare** to add the drive as a hot spare.
4. Click **Make Global Spare** if you want to create a global hot spare for all disk groups.

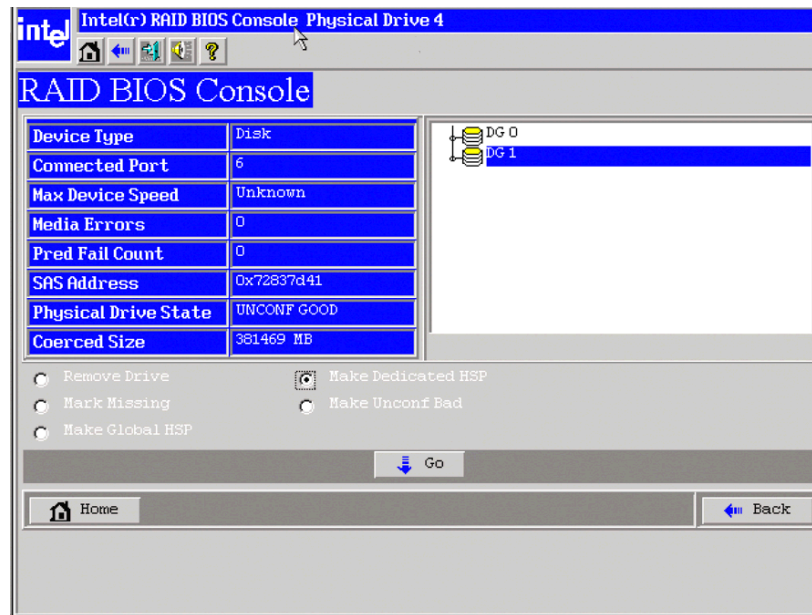

Figure 25. RAID BIOS Console 2 – Setting a Hot Spare Drive

5. Click **Go** to create the hot spare. The Drive State changes to **HOTSPARE**, as shown below.

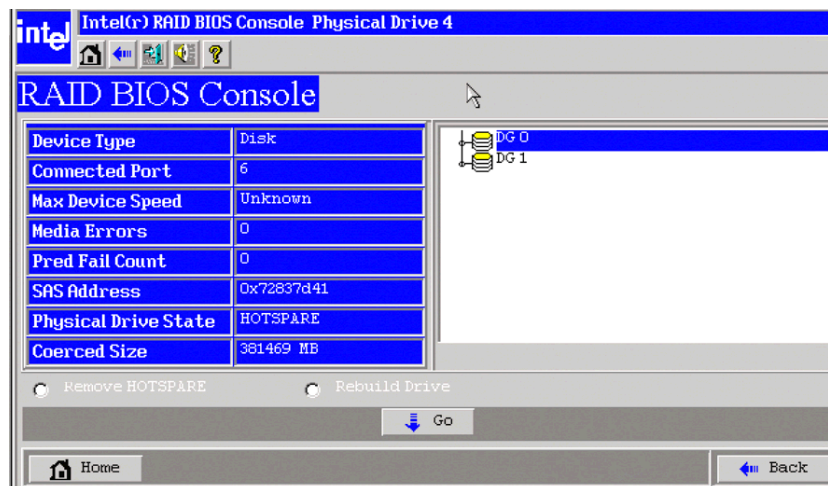

Figure 26. RAID BIOS Console 2 – Viewing Hot Spare

6. Click **Home** to return to the main screen.

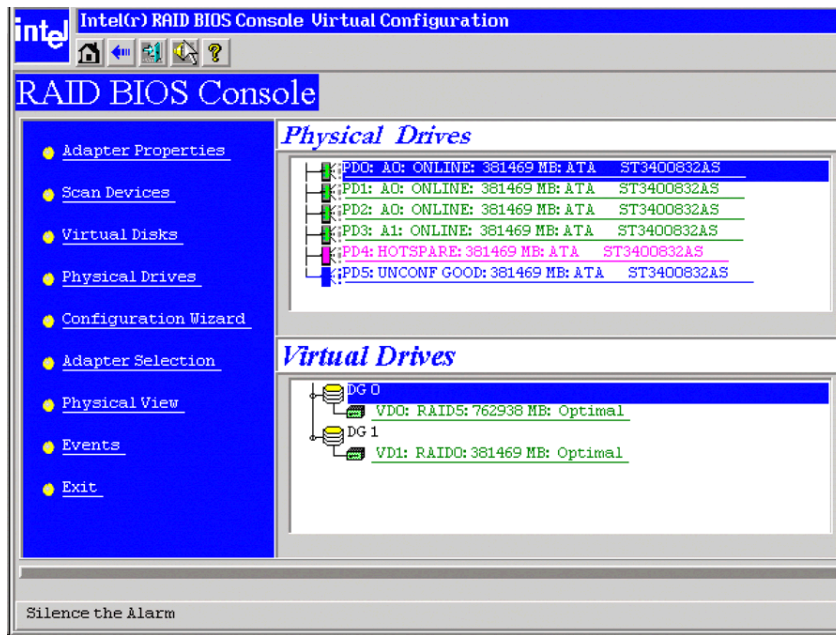

Figure 27. RAID BIOS Console 2 – Main Screen showing Hot Spare Drive

Viewing Event Details

Events contain information, warnings, and fatal events. Events can be captured on various RAID controller components, such as the battery, physical card, and within the configuration. These events can be viewed by using the following steps.

1. Select **Event Links** from the menu at the left. The events screen is displayed, as shown below.

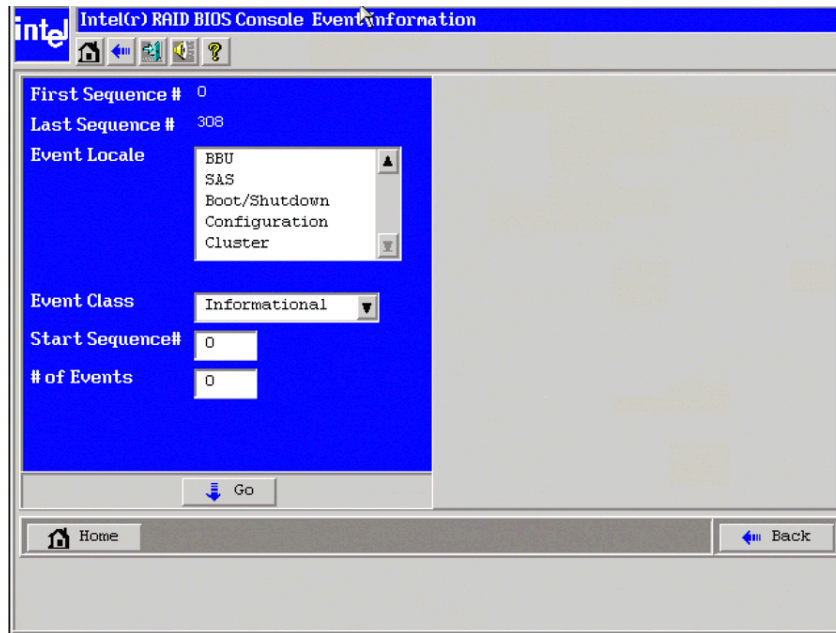

Figure 28. RAID BIOS Console 2 – Event Information Screen

2. Select the component to display from the list in the **Event Locale** list box.
3. Select the type of event to display from the **Event Class** drop-down.
4. Select the **Start Sequence#** and the **# of Events** to display.

The following example shows a selection has been made for informational events for the logical drive, starting at sequence number 120 and displaying 10 events.

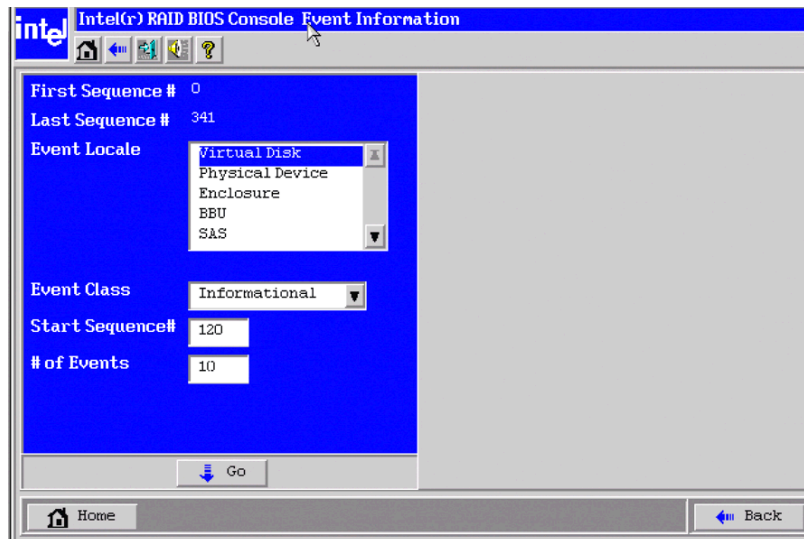

Figure 29. RAID BIOS Console 2 – Selecting Events to View

5. Click **Go**. In this example, logical drive events for informational messages have been selected, starting with the event at sequence 120. The events screen displays the event information for sequence number 120 in the right pane.

*Note: In the sample, the Start Sequence# and the # of Events fields each display 0. These fields automatically reset to 0 when you click **Go** to display the events.*

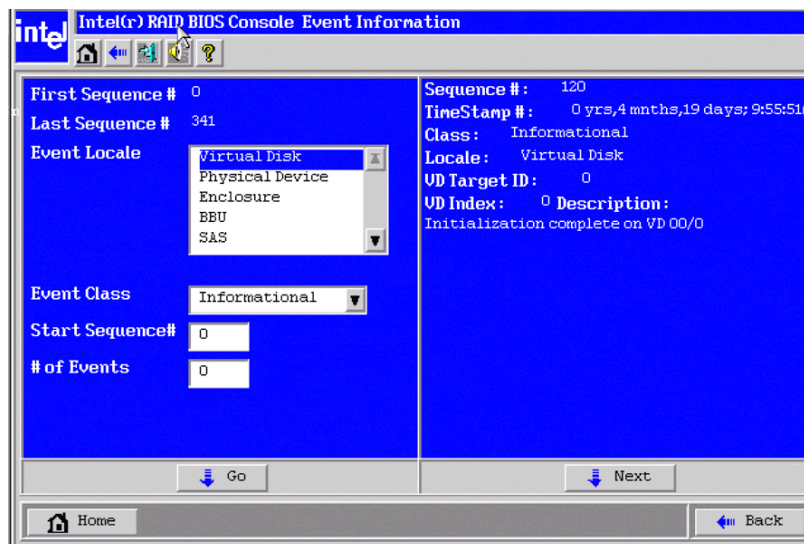

Figure 30. RAID BIOS Console 2 – Viewing an Event

6. Click **Next** to view the next message.

5 Intel® RAID Web Console 2

The Intel® RAID Web Console 2 enables you to configure, monitor, and maintain Intel® RAID Controllers and the storage related devices connected to the RAID controller. The Intel® RAID Web Console 2 graphical user interface makes it easy to create and manage storage configurations.

Configuration Functions

The Intel® RAID Web Console 2 enables you configure the controllers, disk drives, battery backup units, and other storage-related devices installed on a system.

- The Configuration Wizard simplifies the process of creating disk arrays and disk groups, and logical drives.
- Auto Configuration mode automatically creates the best possible configuration for the available hardware.

Note: Auto Configuration cannot be used for RAID 10 or 50 or with mixed SATA and SAS drives.

- Guided Configuration mode asks you a few brief questions about the configuration, and then creates the array for you.
- Manual Configuration mode, which gives you complete control over all aspects of the storage configuration.
- The Reconstruction Wizard enables you to increase or reduce the size of a logical drive and to change the RAID level of an array.

Monitoring Functions

The Intel® RAID Web Console 2 displays information on the status of logical drives, physical disks, and other storage-related devices on the systems that you are monitoring. System errors and events are recorded in an event log file and are displayed on the screen. Special device icons appear on the screen to notify you of disk failures and other situations that require immediate attention.

Maintenance Functions

Use the Intel® RAID Web Console 2 to perform system maintenance tasks such as running patrol read operations, updating firmware, and running consistency checks on arrays and disk groups that support redundancy.

Hardware and Software Requirements

The hardware requirements for Intel® RAID Web Console 2 software are as follows.

- PC-compatible computer system with at least on Intel® Xeon® architecture processor or an Intel® Extended Memory 64 Technology (Intel® EM64T) 64-bit processor
- At least 256 Mbytes of system memory
- Hard disk drive with at least 50 Mbytes available free space
- A supported operating system:
 - Microsoft Windows 2000*, Microsoft Windows Server 2003*, or Microsoft Windows XP*
 - Red Hat* Linux Enterprise 3.0 or 4.0
 - SUSE* Enterprise Linux 9.0

Installing the Intel® RAID Web Console 2 on a Windows Operating System

To install the Intel® RAID Web Console 2 on a Microsoft Windows 2000, Microsoft Windows Server 2003, or Microsoft Windows XP system, follow these steps:

1. Insert the *Resource CD* in the CD-ROM drive.
2. When the Welcome screen is displayed, click **Next**.
3. When the next screen is displayed, read and accept the user license and click **Next**. The Customer Information screen is displayed, as shown in [Figure 31](#).

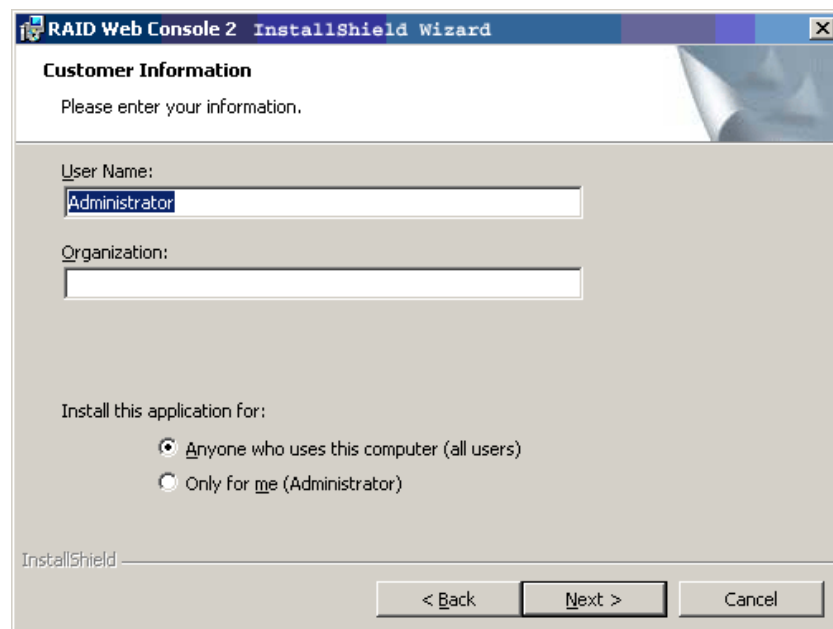

Figure 31. Intel® RAID Web Console 2 – Customer Information Screen

4. Enter your user name and organization name. In the bottom part of the screen, select an installation option:
 - If you select **Anyone who uses this computer**, any user with administrative privileges can view or change the RAID configurations.
 - If you select **Only for me**, only you can view or change the RAID configurations.
5. Click **Next** to continue.
6. Accept the default Destination Folder, or click **Change** to select a different destination folder. Click **Next** to continue. The Setup Type screen is displayed, as shown in [Figure 32](#).

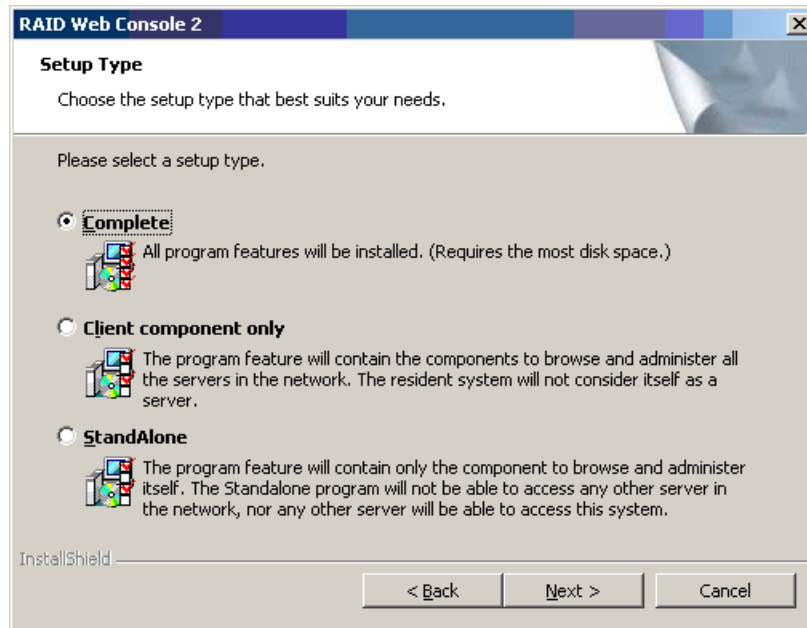

Figure 32. Setup Type Screen

7. Select one of the Setup options.
 - Select **Complete** if you are installing the Intel[®] RAID Web Console 2 on a system.
 - Select **Client component only** if you are installing the Intel[®] RAID Web Console 2 on a PC that will be used to view and configure systems over a network.
 - Select **StandAlone** if you will use the Intel[®] RAID Web Console 2 to create and manage storage configurations on a standalone workstation.
8. Click **Next** to proceed.
9. Click **Finish** to complete the installation process.

Installing the Intel® RAID Web Console 2 on Linux or SUSE SLES

To install Intel® RAID Web Console 2 on a system running Red Hat* Linux 3.0/4.0 or SUSE* SLES 9, follow these steps:

1. Unzip the file `ir3_Linux_RWC2_v...tgz`.
2. In the unzipped files, read the `readme.txt` file.
3. Run `install.sh` and follow the instructions that appear on the screen.

The three setup options are the same as those shown in [step 7](#) of the Windows installation instructions.

Startup, Overview, and Setup of Intel® RAID Web Console 2

Follow these steps to start the Intel® RAID Web Console 2:

- **Windows:** select **Start | All Programs | RAID Web Console 2 | StartupUI**, or double-click the Intel® RAID Web Console 2 icon on the desktop.
- **RHEL3 U6:** Select **Start | System Tools | RAID Web Console 2 StartupUI**.
- **SLES 9 SP1:** Select **Start | System | More Programs | RAID Web Console 2 StartupUI**.

Intel® RAID Web Console 2 Screens

This section describes the main Intel® RAID Web Console 2 screens. When you start the Intel® RAID Web Console 2, the Select Server window is displayed.

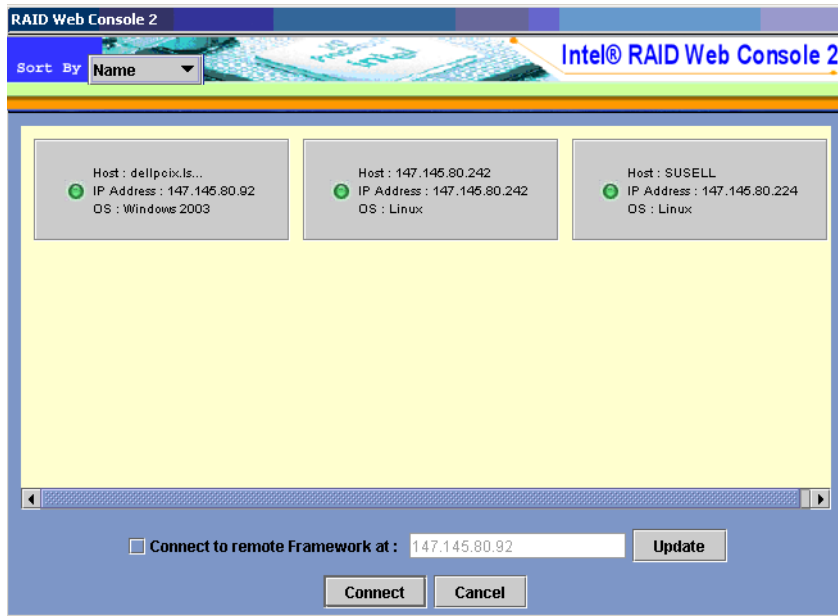

Figure 33. Intel® RAID Web Console 2 – Select Server Screen

Note: To access systems on a different subnet, type in the box at the bottom of the screen the IP address of a system in the desired subnet where Intel® RAID Web Console 2 is running and click Update. If you check the Connect to remote framework box, you can also access a standalone server running Intel® RAID Web Console 2, if it has a network connection

Color Coding: If the circle in the server icon is yellow instead of green, it means that the system is running in a degraded state. For example, a disk drive used in a logical drive has failed. If the circle is red, the storage configuration in the system has failed.

To log in to a system, follow these steps:

1. Double-click the icon of the system that you want to access. The Server Login window is displayed.

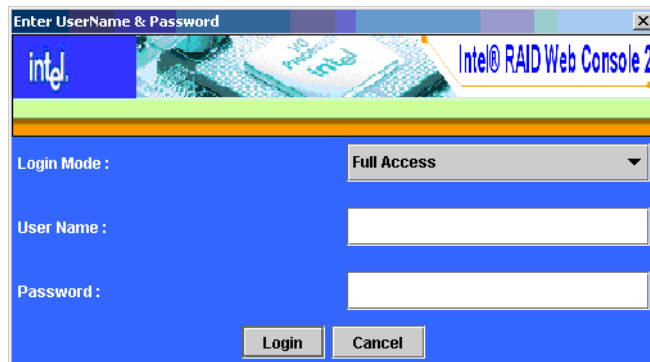

Figure 34. Intel® RAID Web Console 2 – Login Screen

2. Select an access mode from the drop-down menu.
 - Select **Full Access** if you need to both view the current system configuration and change the configuration.
 - Select **View Only** if you only need to view the system configuration.
3. Enter your user name and password and click **Login**. If your user name and password are correct for the login mode you have chosen, the main screen is displayed.

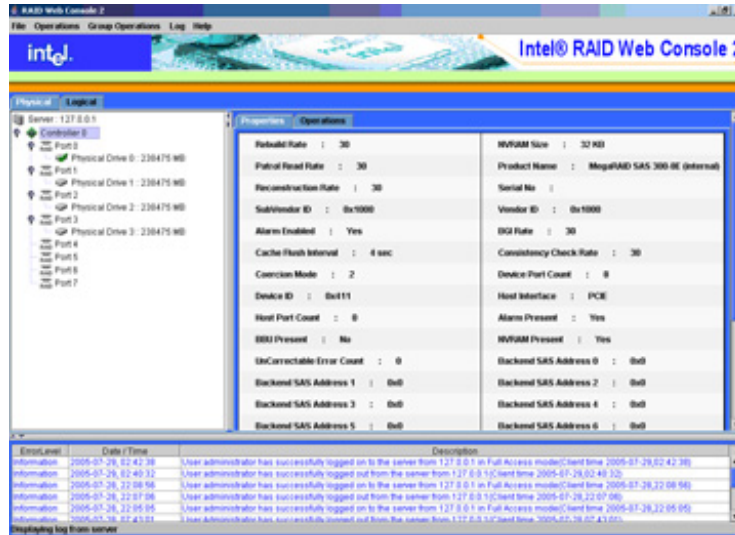

Figure 35. Intel® RAID Web Console 2 – Main Screen

The system shown has one controller, a RAID enclosure, and four physical drives.

The following subsections describe this screen in more detail.

Physical/Logical View Panel

The left panel displays either the Physical View or the Logical View of the system and the devices in it, depending on which tab is selected.

- The Physical View shows the hierarchy of physical devices in the system. At the top of the hierarchy is the system itself. Controllers are installed in the system, and each controller has one or more ports. Disk drives and other physical devices are attached to the ports.
- The Logical View shows the hierarchy of systems, controllers, logical drives, and arrays and disk groups that are defined for the system.

Small icons represent the servers, controllers, and other devices. A red circle to the right of an icon indicates that the device has failed. For example, this icon indicates that a disk drive has failed: 

A yellow circle to the right of an icon indicates that a device is running in a degraded state. For example, this icon indicates that a logical drive is running in a degraded state due to the failure of a disk drive: 

Properties/Operations/Graphical View Panel

The right panel has either two or three tabs, depending on the kind of device that is selected in the left panel, and depending on your login mode (full-access or view-only).

The Properties tab displays information about the selected device.



Figure 36. Intel® RAID Web Console 2 – Operations Tab

The Operations tab lists the operations that can be performed on the device that is selected in the left panel. (This tab is available only when you are logged in to Intel® RAID Web Console 2 in Full-access mode.) Options available for controllers include: enabling or silencing the alarm, flashing the firmware, and so on. Some types of devices, such as arrays, disk groups, and ports, do not have operations associated with them.

The Graphical tab is available in the right panel if a physical drive or a logical drive is selected on the left. In the Graphical View, the device's storage is color coded to show used capacity, unused capacity, and so on.

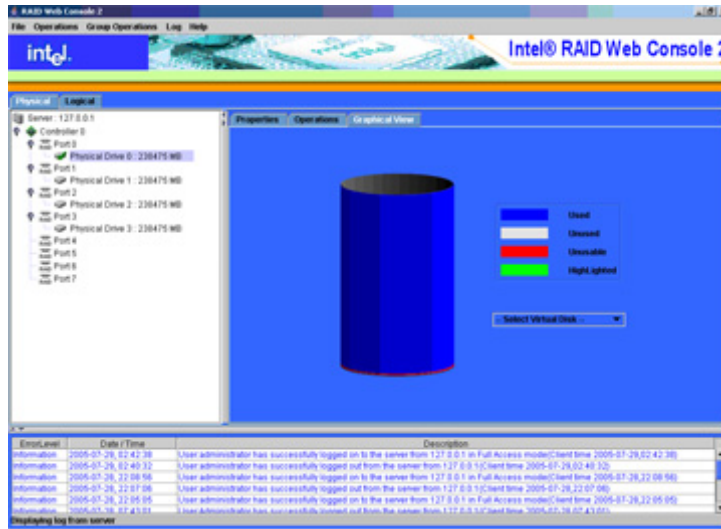

Figure 37. Intel® RAID Web Console 2 – Graphical Tab

Event Log Panel

The lower part of the screen displays the event log entries for the system. New event log entries appear during the session. Each entry has a time and date stamp, an Error Level that indicates the severity of the event, and a brief description of the event. For information about the event log entries, see [Appendix B: “Events and Messages.”](#)

Menu Bar / File Menu

The File menu includes the Exit option to close the Intel® RAID Web Console 2. It also includes a Rescan option to update the screen with the latest configuration information.

Menu Bar / Operations Menu

The Operations menu is available only when a controller, physical drive, logical drive, or other storage object is selected in the main window. The options on the Operations menu vary by item selected. For example, the Enable Alarm and Silence Alarm options are available only when a controller is selected. The options also vary depending on the current state of the selected object. For example, if an offline physical drive is selected, the Make Drive Online option is displayed in the Operations menu.

You can also view the Operations selections from the Operations tab in the right panel. If an operation requires user input before it can be executed, it appears in the Operations tab but not in the Operations menu. A device-specific operations menu pops up if you right-click a device icon in the left panel.

An Advanced Operations sub-menu is also available. On this menu, you access the Configuration Wizard and other configuration-related commands.

File Menu / Group Operations Menu

The Group Operations menu options include Check Consistency, Initialize, and Show Progress.

File Menu / Log Menu

The Log menu includes options for saving and clearing the message log.

File Menu / Help Menu

The Help menu provides access to the online help file and Intel[®] RAID Web Console 2 version information.

Drive Configuration Tasks

You can use Intel[®] RAID Web Console 2 to perform the following configuration tasks:

- [Creating a New Configuration](#)
- [Creating a Spanned Disk Array or Disk Group](#)
- [Creating Hot Spares](#)
- [Setting Adjustable Task Rates](#)
- [Adding a Drive to a Virtual Disk](#)
- [Removing a Drive from a Virtual Disk](#)
- [Changing the RAID Level of a Virtual Disk](#)
- [Changing Virtual Disk Properties](#)
- [Deleting a Virtual Disk](#)
- [Managing Configurations](#)

Configuration Wizards

Use the Configuration Wizard to create disk arrays, disk groups, and virtual disks. The Configuration Wizard can create simple configurations automatically. For more complex configurations, the Configuration Wizard allows you to customize the configuration parameters according to your needs.

The Reconstruction Wizard allows you to easily change RAID levels, or to expand or reduce the capacity of existing logical drives.

Note: *You cannot create or modify a storage configuration unless you are logged on to a system with Administrator privileges.*

Creating a New Configuration

You use the Intel® RAID Web Console 2 Configuration Wizard to create new disk arrays, disk groups, and virtual disks.

1. To open the Configuration Wizard, select a controller in the left panel and then select **Operations | Advanced Operations | Configuration | Configuration Wizard**. The first Configuration Wizard screen is displayed.

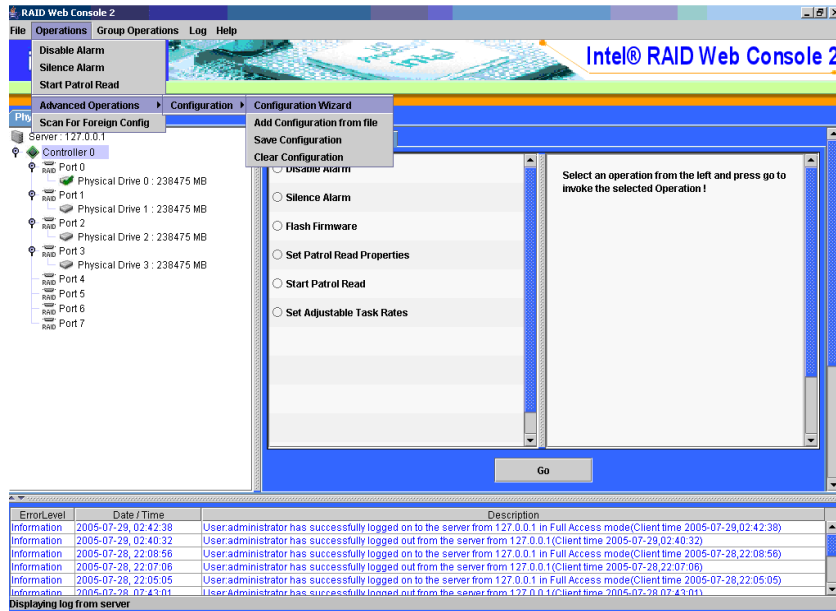

Figure 38. Intel® RAID Web Console 2 – Starting Configuration Wizard

2. Select an option to proceed, or click **Cancel** to close the window.

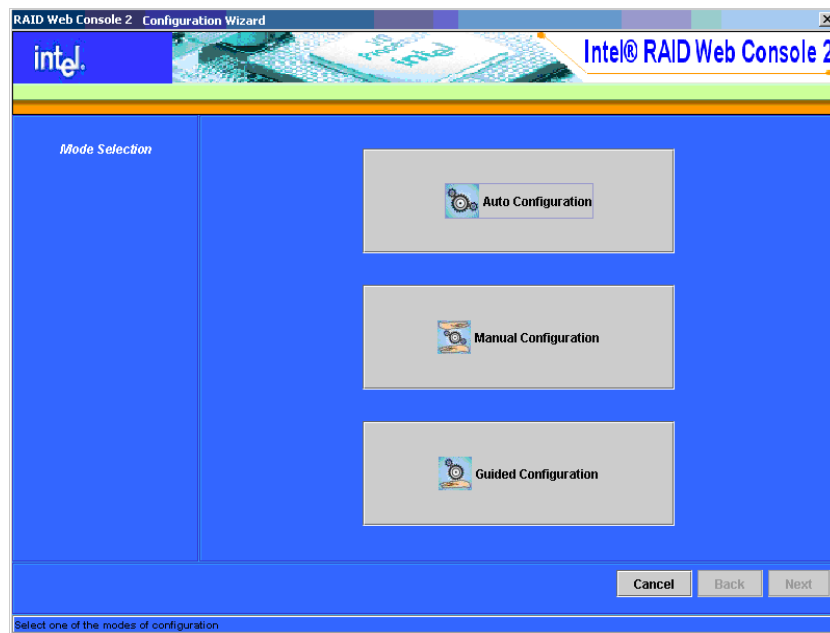

Figure 39. Intel® RAID Web Console 2 – Selecting Type of Configuration

The following sections explain how to use the three options:

- *Auto Configuration* automatically configures the available drives into an optimal configuration.

Note: *Auto Configuration cannot be used for RAID 10 or 50 or with mixed SATA and SAS drives.*

- *Manual Configuration* gives you the greatest level of control in creating a new virtual disk.
- *Guided Configuration* asks you a few simple questions about what kind of configuration you want and then automatically creates it.

Auto Configuration

Note: *Auto Configuration cannot be used for RAID 10 or 50 or with mixed SATA and SAS drives.*

Auto Configuration is the quickest and simplest way to configure a virtual disk. When you select Auto Configuration, Intel® RAID Web Console 2 creates the best configuration possible using the controllers and physical disks that are available. Figure 40 shows the Auto Configure screen.

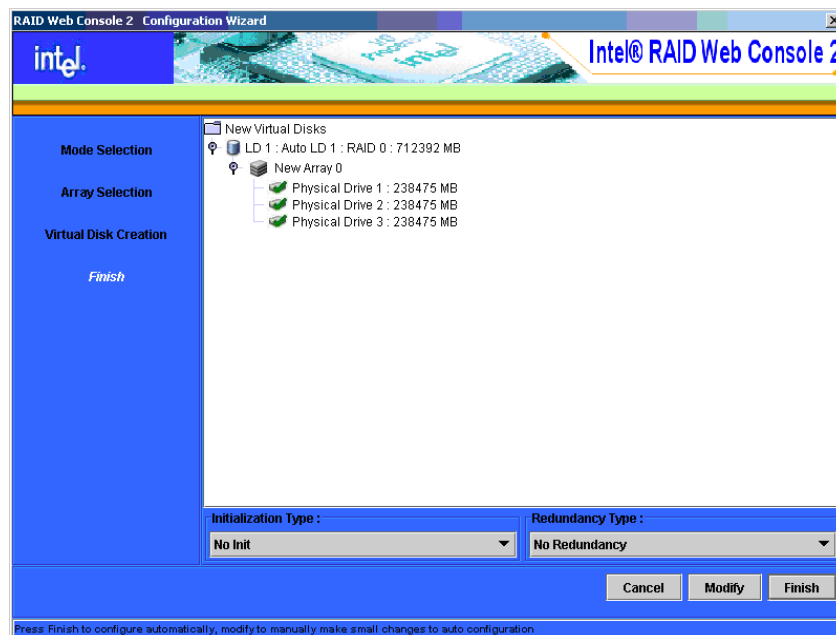

Figure 40. Intel® RAID Web Console 2 – Auto Configuration Screen

Follow these steps to complete Auto Configuration:

1. Select a Redundancy option from the drop-down menu at the bottom of the screen:
 - **No Redundancy:** The virtual disk will have no data redundancy (RAID 0). If a physical disk fails, all data is lost.
 - **With Redundancy:** The virtual disk will have data redundancy, either via parity data (RAID 5) or duplicated data (RAID 1). If a physical disk fails, data will not be lost.

2. Select an Initialization option from the drop-down menu at the bottom of the screen:
 - **No Init:** Select this option if you do not want to initialize the new configuration at this time. If you select this option, be sure to initialize the configuration later. For more information, see [“Initializing a Virtual Disk,” on page 92.](#)
 - **Quick Init:** Select this option to quickly initialize the configuration by writing zeros to the first and last 10 Mbyte regions of the virtual disk.
 - **Full Init:** Select this option to run a complete initialization of the configuration. This may take a long time, depending on the number and capacity of the physical disks.
3. Click **Modify** if you want to make changes to the Auto Configuration. For example, you could modify the size of a virtual disk.
4. Click **Finish**. The storage configuration will be created and initialized, unless you selected **No Init**.

Manual Configuration

Manual Configuration allows you the greatest level of control in creating a new configuration. When you select Manual Configuration, [Figure 41](#) shows the first screen that is displayed:

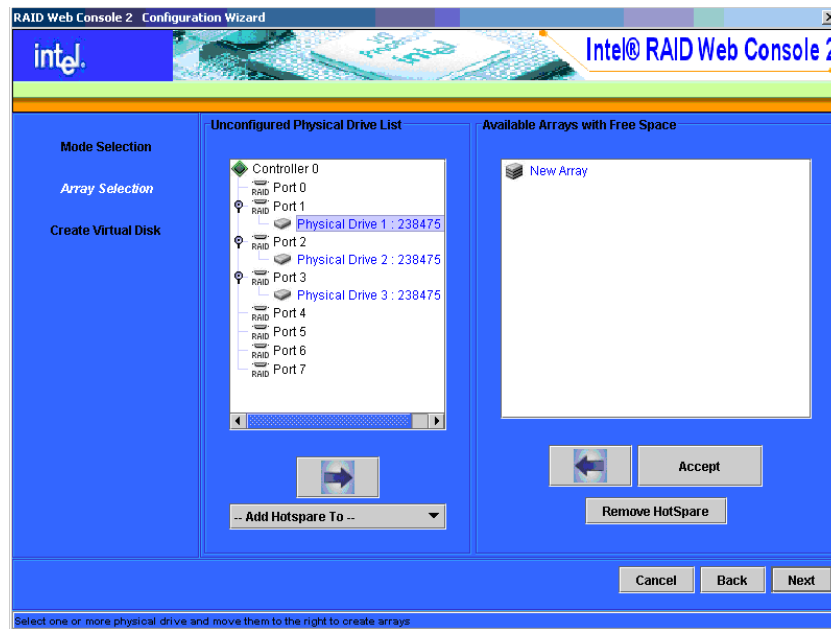

Figure 41. Intel® RAID Web Console 2 – First Manual Configuration Screen

The panel on the left shows the unconfigured physical drives that are available to create a new array or disk group. The right panel shows new arrays or disk groups as you define them. It also shows existing arrays or disk groups that have “holes” — free space that can be used to form new virtual disks.

Step 1: Defining New Arrays or Disk Groups

To define new arrays or disk groups with the Manual Configuration option, follow these steps:

1. Select available drives in the left panel. You can Shift-click to select a range of drives, or Ctrl-click to select multiple drives individually. Click the arrow button below the panel to move the drives to the right panel.
2. When you have selected all the drives you want for the array or disk group, click **Accept** to accept these drives for the new array or disk group.
3. Select drives for another array or disk group, if desired, and click **Accept**.
4. To add a dedicated hotspare to an array or disk group that you have defined, select an available drive in the left panel, select the array or disk group from the drop-down panel, and click **Add HotSpare To**.

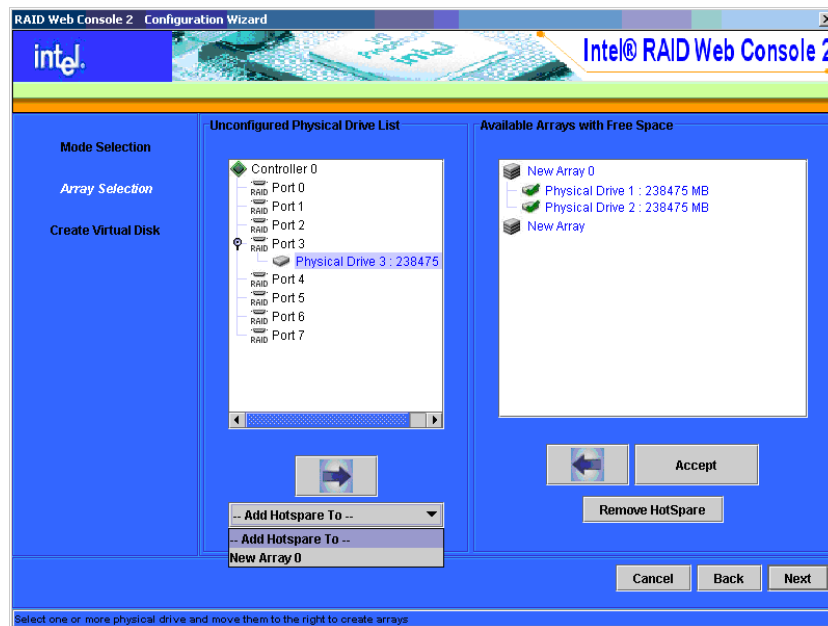

Figure 42. Intel® RAID Web Console 2 – Selecting Drive for Hotspare

Figure 43 shows a newly defined disk group with a dedicated hotspare.

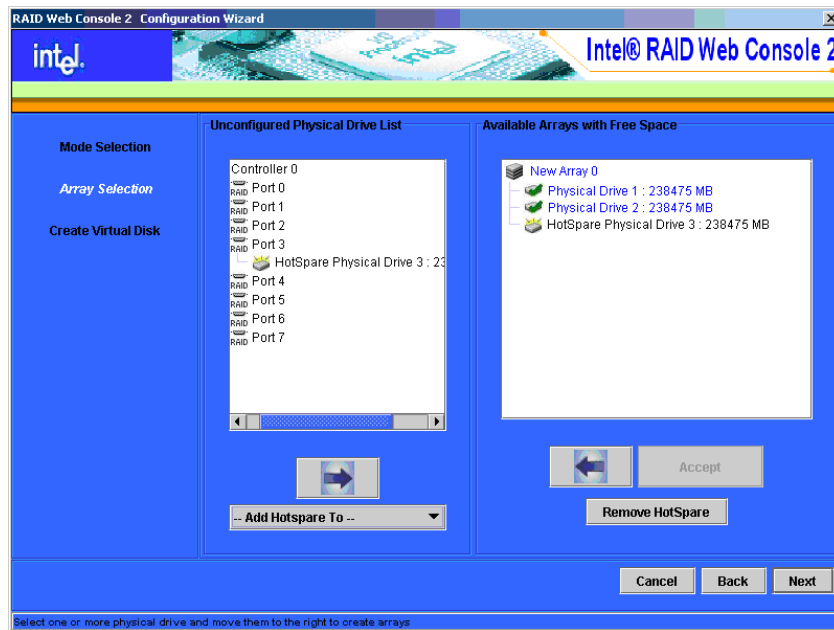

Figure 43. Intel® RAID Web Console 2 – New Disk Group with Hotspare

Note: To remove all physical drives from a proposed array or disk group, select the **New Array** icon in the right panel and click the left-pointing button. To remove a single drive from a proposed array or disk group, select the drive icon in the right panel and click the left-pointing button. To remove a dedicated hotspare from an array or disk group, select it in the right panel and click **Remove HotSpare**.

5. Click **Next** to continue with the next configuration step.

Step 2: Defining Virtual Disks

The next Manual Configuration screen is displayed, as shown in Figure 44.

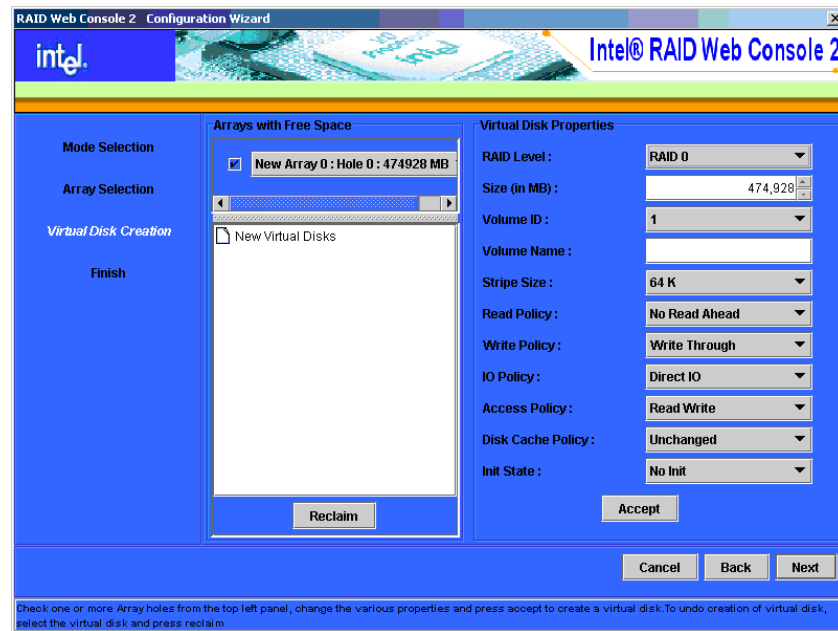

Figure 44. Intel® RAID Web Console 2 – Defining a Virtual Disk

The scrolling menu in the upper middle panel shows arrays or disk groups with available space—both the array(s) / disk group(s) that you defined on the previous screen and any existing arrays or disk groups with “holes” (free space). A single array or disk group can have multiple holes, which you can see in the drop-down menu for the array or disk group.

6. Click check boxes in the menu to select arrays or disk groups, and holes that you want to use for the new virtual disk. Select multiple check boxes to create a spanned configuration.
7. When you have selected all of the space you need for the virtual disk, change the default virtual disk properties in the right panel, if needed.

Note: You can change the virtual disk properties later after the disk is created by selecting **Operations | Set Virtual Disk Properties**.

8. Click **Accept** to accept the configuration of the new virtual disk. This is displayed in Figure 45.

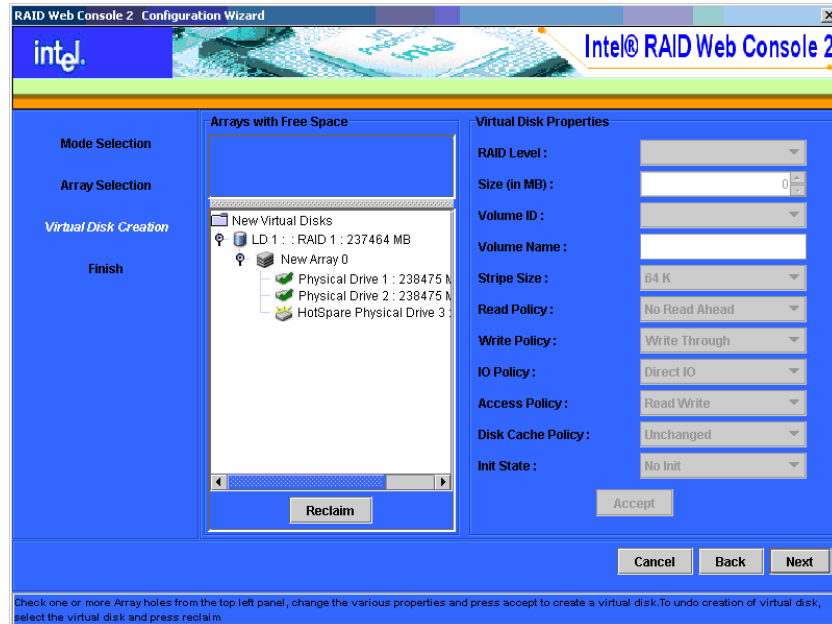

Figure 45. Manual Configuration – New Configuration

Note: Click **Reclaim** if you want to undo a virtual disk that you just defined.

9. Select the available space and define its properties, or click **Next** to continue with the next configuration step.

Step 3: Accepting the Configuration

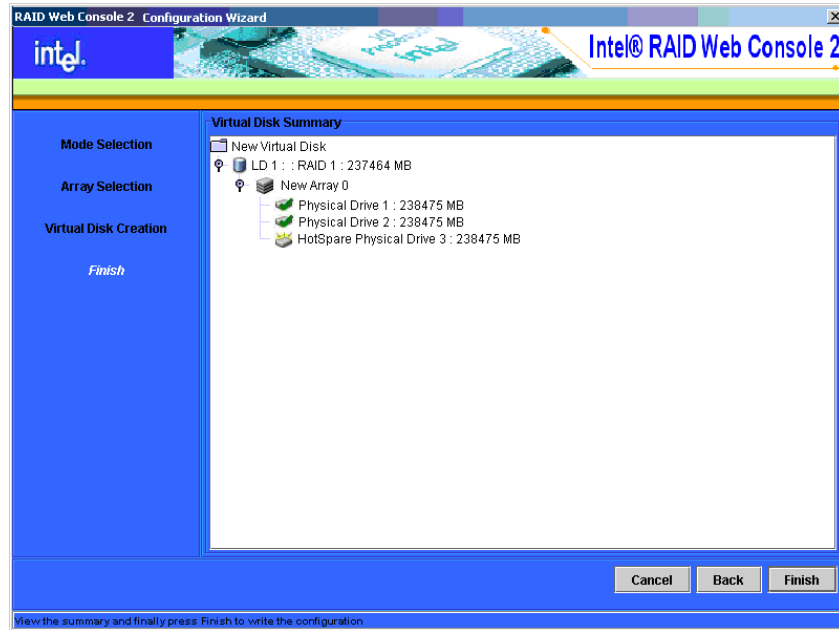

Figure 46. Manual Configuration – Virtual Disk Summary

10. Review the configuration. If you want to change something, click **Back** and change the configuration parameters.
11. If the configuration is acceptable, click **Finish** to accept it and to start the actual initialization process (unless you selected the No Init option on the previous screen).

Guided Configuration

The Guided Configuration creates the best possible configuration on the controller after asking you a few simple questions. [Figure 47](#) shows the first screen that is displayed when you select Guided Configuration:



Figure 47. First Guided Configuration Screen

Follow these steps to complete Guided Configuration:

1. Select a Redundancy option:
 - **Redundancy Only:** Create a configuration only if redundancy is possible and if there are enough available disk drives.
 - **Redundancy when possible:** Create a redundant configuration if possible. Otherwise, create a non-redundant configuration.
 - **No Redundancy:** Create a non-redundant configuration.
2. Choose whether you want to use existing arrays or disk groups in the new virtual disk. The options are:
 - **Use Existing Arrays Only:** This option is disabled if there are no available existing arrays or disk groups.
 - **Don't Use Existing Arrays**
 - **Use Existing and New Arrays:** This option is disabled if there are no available existing arrays or disk groups.
3. Select a maximum number of virtual disks to be created. The Intel[®] RAID Web Console 2 may not be able to create as many virtual disks as you want, depending on the current configuration and the number of virtual disks that have already been created.
4. Click **Next** to continue to the next screen, as shown in [Figure 48](#).



Figure 48. Guided Configuration – Parameters

5. Change the default volume parameters on this screen, if needed.

In this example, RAID 0 and RAID 1 volumes are being configured. In the top section of the screen you can specify the number of virtual disks to create. You can also choose to use less than the full capacity of this array or disk group for the virtual disk(s). You might want to do this to leave capacity available for other virtual disks that you create later. However, in some situations the remaining space might not be usable.

6. Click **Next** to continue to the next screen, as shown in [Figure 49](#).

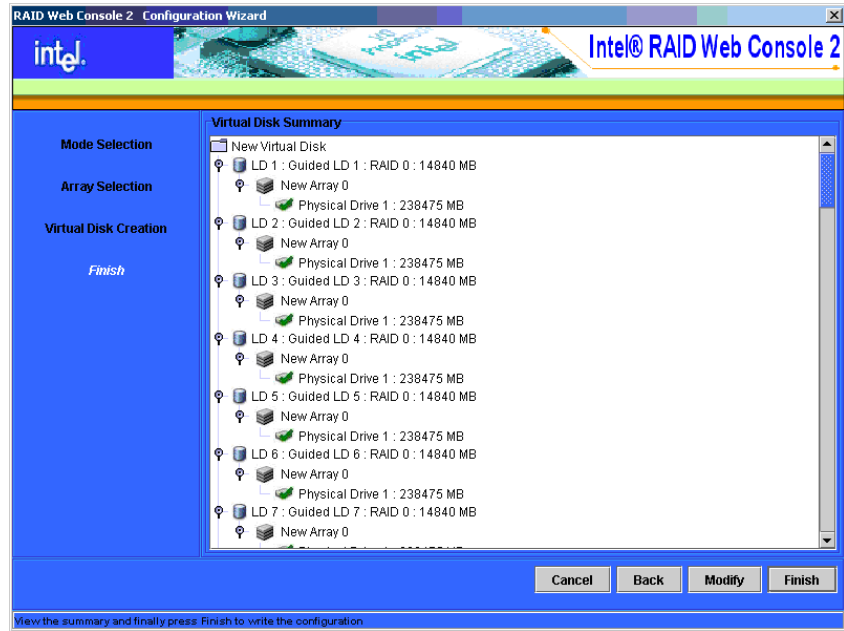

Figure 49. Final Guided Configuration Screen

7. Check the configuration that you have just defined. If it is acceptable, click **Finish**. If you want to change something, click **Back** to return to previous screens.

Creating a Spanned Disk Array or Disk Group

Spanning allows you to configure multiple arrays as a single virtual disk. Spanned arrays provide additional levels of data redundancy and storage capacity. The Intel[®] RAID Web Console 2 supports three types of spanned arrays or disk groups:

- RAID 00 (multiple RAID 0 arrays or disk groups)
- RAID 10 (multiple RAID 1 arrays or disk groups)
- RAID 50 (multiple RAID 5 arrays or disk groups)

Follow these steps to create a spanned disk array or disk group. The example given here is for RAID 10, but the steps are the same for RAID 00 or RAID 50.

1. Open the Configuration Wizard and select the **Manual Configuration** option.
2. On the first Manual Configuration screen, select disks for two or more RAID 1 arrays or disk groups (two disks per array or disk group).
3. Select hot spares for the arrays or disk groups, if desired, and click **Next** when you have defined all the arrays or disk groups you want.
4. On the next screen (Virtual Disk Creation), select two or more of the new arrays or disk groups from the Arrays with Free Space menu, as shown in [Figure 50](#). You can select up to eight arrays or disk groups for the spanned array.

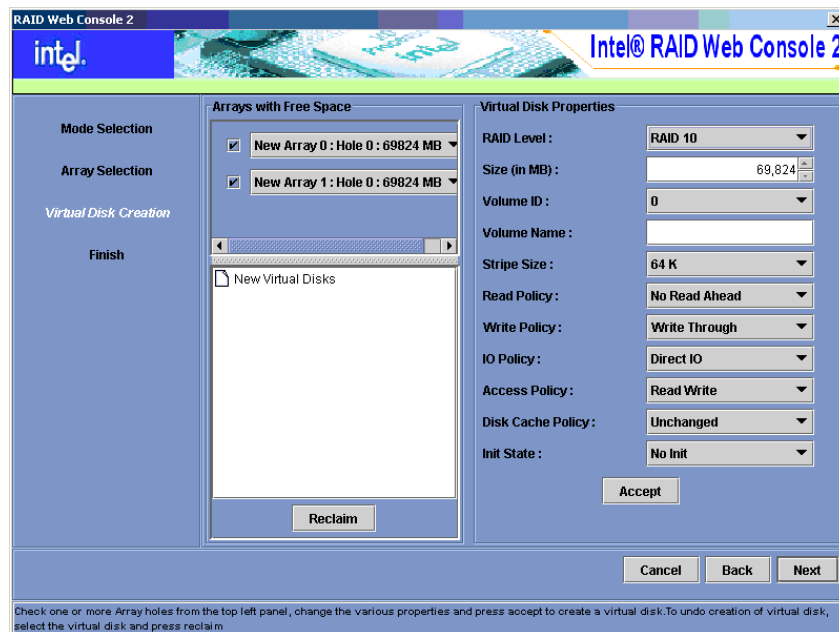

Figure 50. Defining the Spanned Array

5. Select RAID 10 from the drop-down RAID Level menu, as shown in [Figure 50](#), or select RAID 0 or RAID 50 for the other types of spanned arrays or disk groups.
6. Change the virtual disk properties as needed, and then click **Accept** to accept the spanned array. The newly defined virtual disk is displayed, as shown in [Figure 51](#).

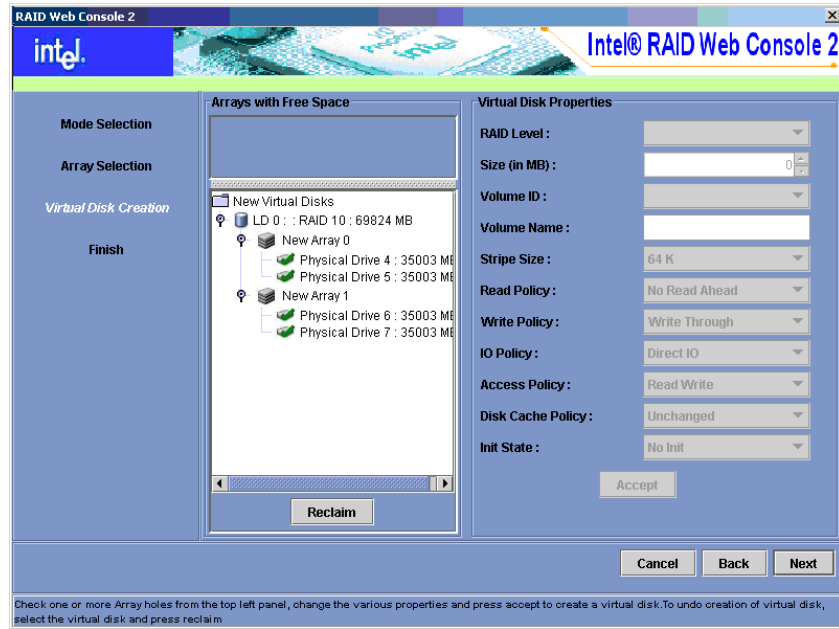

Figure 51. New Spanned Array

7. Click **Next** to continue, and click **Finish** in the last screen to complete the process.

Creating Hot Spares

Hot spares are disk drives that are available to automatically replace failed drives in a virtual disk. There are two kinds of hot spares: 1) dedicated hot spares, which are available one or more specified arrays or disk groups, and 2) global hot spares, which are available to any array or disk group defined on the controller.

To create a global hot spare, follow these steps:

1. In the left panel of the Intel® RAID Web Console 2 window, right-click the icon for any disk drive that is not already part of an array or disk group.
2. Select **Make Global Hotspare**.



Figure 52. Make Global Hotspare

You normally create a dedicated hot spare when you create a new configuration with the Manual Configuration option (see “Manual Configuration,” on page 58). To add a dedicated hot spare to an existing array or disk group, follow these steps:

1. In the left panel of the Intel® RAID Web Console 2 window, click the icon of a disk drive that is not already assigned to a storage configuration. A check mark is displayed on the disk drive icon if it is already assigned.
2. In the right panel, click the **Operations** tab and select **Make Dedicated Hotspare**, as shown in Figure 53.



Figure 53. Creating a Dedicated Hotspare

3. Select the array or disk group to which the hotspare will be dedicated from the list on the right.



Figure 54. Select Hotspare Drive

4. Click **Go** to create the dedicated hotspare.

Setting Adjustable Task Rates

If you want to change the Rebuild rate and other task rates for a controller, you must first log onto the system in All Access mode (versus View-Only mode). Then follow these steps to set the adjustable task rates:

1. Select a controller icon in the left panel, and select the **Physical View** tab.
2. In the right panel, select the **Operations** tab and select **Adjustable Task Rates**. The task rates appear at the right, as shown in Figure 55.

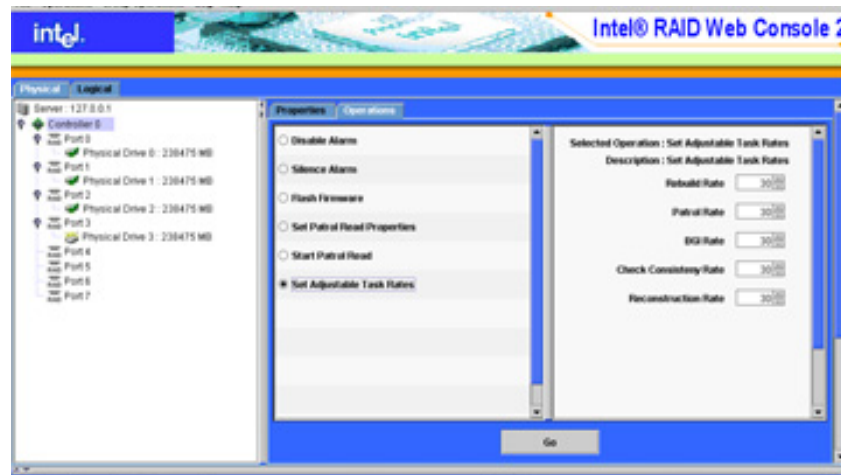

Figure 55. Set Adjustable Task Rates

3. Enter changes as needed to any of the task rates:
 - **Rebuild Rate.** Enter a number from 0 to 100 to control the rate at which a rebuild will be performed on a disk drive when one is necessary. The higher the number, the faster the rebuild will occur. The system I/O rate might be slower as a result of selecting a high number.
 - **Patrol Rate.** Enter a number from 0 to 100 to control the rate at which patrol reads will be performed. Patrol read is a preventive procedure that monitors physical disks to find and resolve potential problem that might cause a disk failure. The higher the number, the faster the patrol read will occur. The system I/O rate might be slower as a result of selecting a high number.
 - **Background Initialization (BGI) Rate** Enter a number from 0 to 100 to control the rate at which virtual disks are initialized in the background. Background initialization makes the virtual disk immediately available for use, even while the initialization is occurring. The higher the number, the faster the initialization will occur. The system I/O rate might be slower as a result of selecting a high number.
 - **Check Consistency Rate.** Enter a number from 0 to 100 to control the rate at which a consistency check is done. A consistency check scans the consistency data on a fault tolerant virtual disk to determine if the data has become corrupted. The higher the number, the faster the consistency check is done. The system I/O rate might be slower as a result of selecting a high number.

- **Reconstruction Rate.** Enter a number from 0 to 100 to control the rate at which reconstruction of a virtual disk occurs. The higher the number, the faster the reconstruction will occur. The system I/O rate might be slower as a result of selecting a high number
4. Click **Go** to accept the new task rates.
 5. When the warning message is displayed, click **OK** to confirm that you want to change the task rates.

Note: *The Controller Operations tab also has options for disabling or silencing the alarm on the controller. Ordinarily you should leave the alarm enabled so it can warn you of abnormal conditions on the controller. You might need to silence the alarm if the alarm is malfunctioning or it is too loud.*

Adding a Drive to a Virtual Disk

You can use Intel® RAID Web Console 2 to increase the capacity of an existing virtual disk by adding physical disk drives to it. In order to do this, you must be logged on to the system in All Access mode.

Warning: Be sure to back up the data on the virtual disk before you change its capacity.

To increase the capacity of a virtual disk, follow these steps:

1. Select a controller icon in the left panel and then select **Operations | Advanced Operations | Configuration | Reconstruction Wizard**.



Figure 56. Starting Reconstruction Wizard

The Reconstruction Wizard window is displayed, as shown in [Figure 57](#).

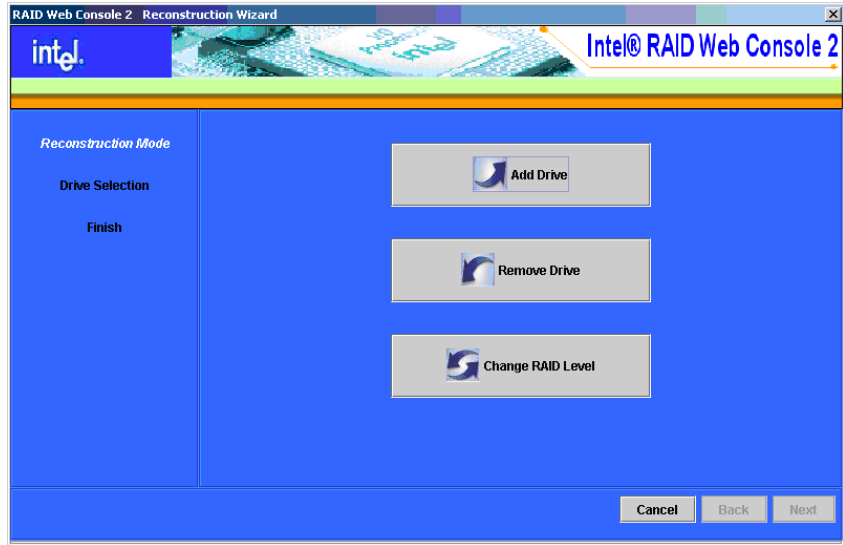

Figure 57. Reconstruction Wizard

2. Click **Add Drive**. The following screen is displayed.

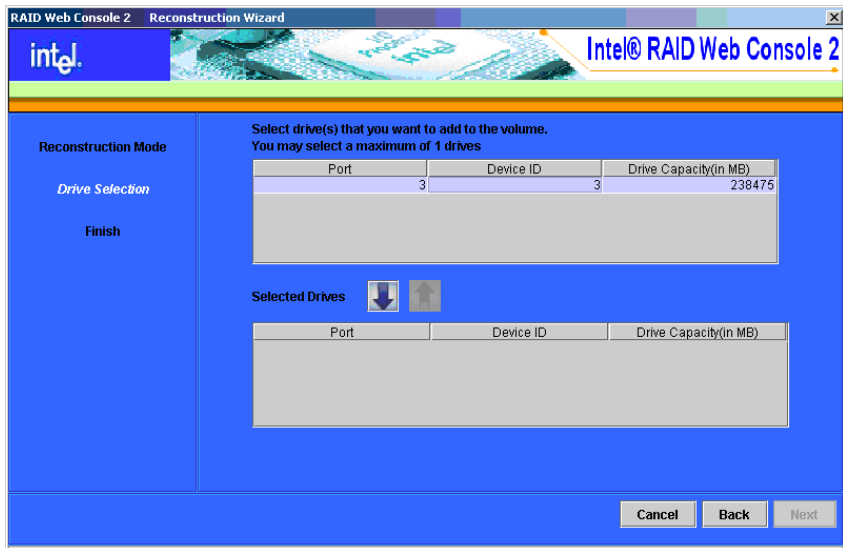

Figure 58. Selecting Drives to Add

3. In the top panel, select the disk drives that you want to add to the virtual disk.
4. Click the down-arrow button to add the drives. To remove a drive from your selection list, click the up-arrow button.

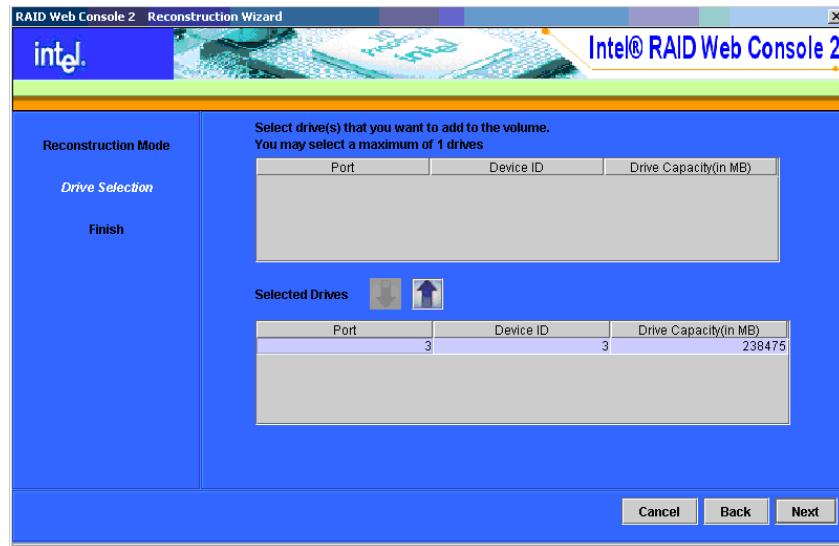

Figure 59. Drive Selected for Virtual Disk

5. When you are finished adding disk drives, click **Next**. The screen on which you can change the RAID level is displayed, as shown in Figure 60.

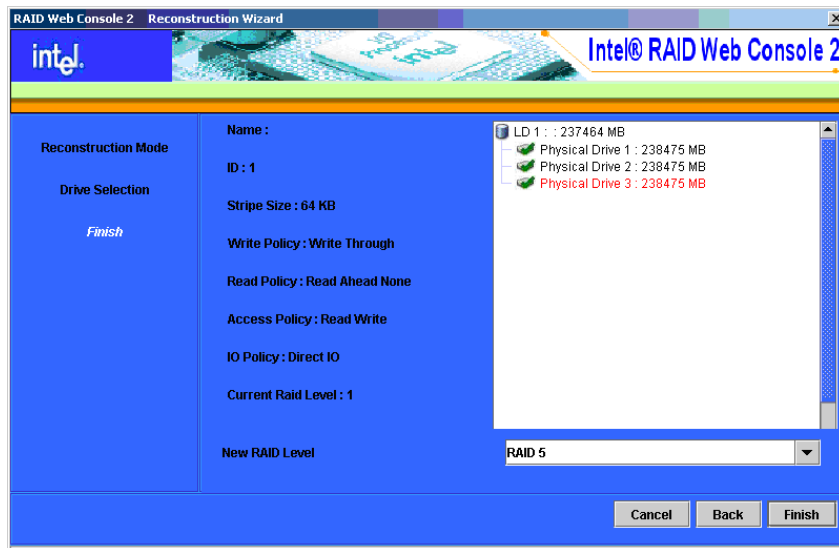

Figure 60. Changing RAID Level

6. If desired, select a new RAID level from the drop-down menu at the lower right part of the window. Review the information for the newly expanded virtual disk.
7. When everything is acceptable, click **Finish** to accept the new configuration.

A Reconstruct operation begins on the virtual disk. You can monitor the progress of the reconstruction in the Group Show Progress window. Select **Group Operations | Show Progress**.

Removing a Drive from a Virtual Disk

You can use Intel® RAID Web Console 2 to remove a physical disk drive from a virtual disk. In order to do this, you must be logged on to the system in All Access mode.

Warning: Be sure to back up the data on the virtual disk before you change its capacity.

1. Select a controller icon and start the Reconstruction Wizard, as described in the previous section.
2. Click **Remove Drive**.
3. In the top panel, select the disk drives that you want to remove from the virtual disk.
4. Click the down-arrow button to remove the drives.

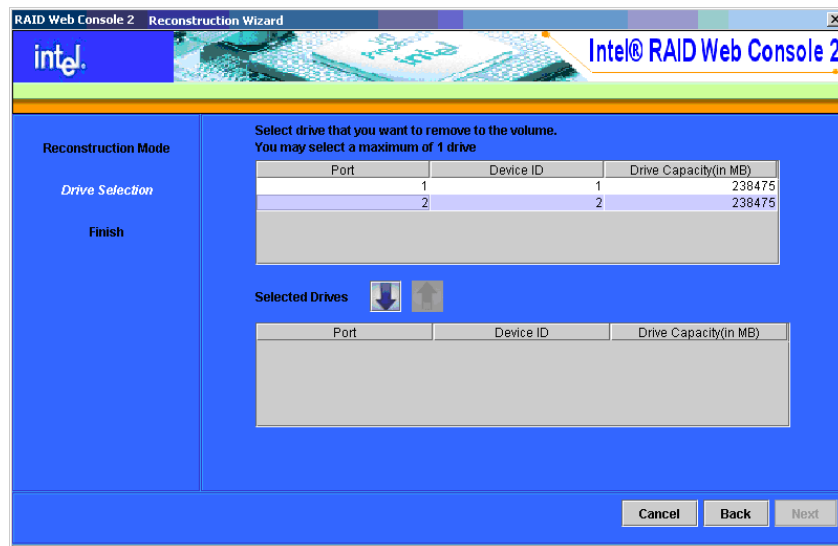

Figure 61. Select Drives to Remove from logical drive

- When you are finished removing disk drives, click **Next** to continue.

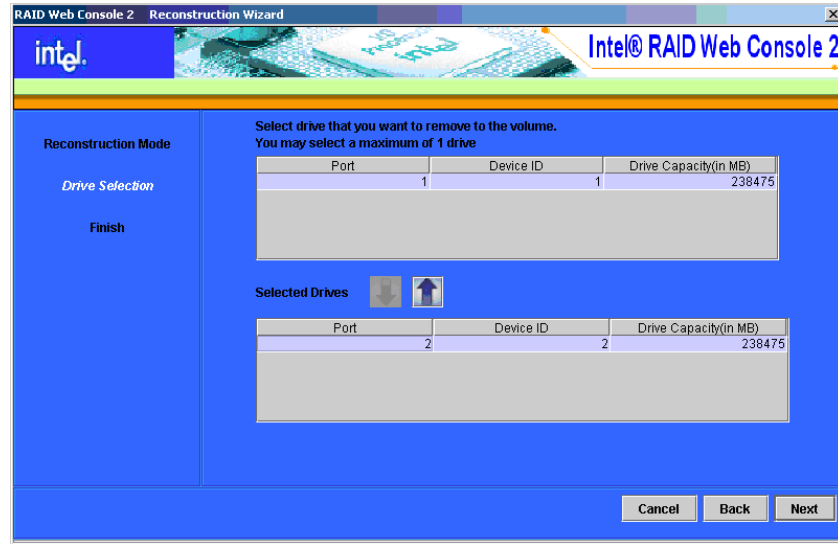

Figure 62. Drive Selected for Removal from logical drive

- When the next screen is displayed, select a new RAID level from the drop-down menu, if desired. Review the displayed information for the virtual disk.

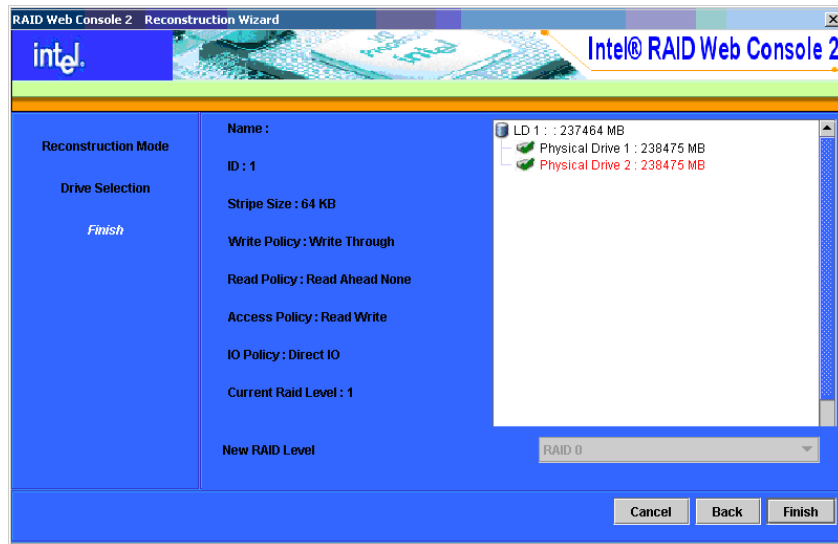

Figure 63. Select RAID Level

- When everything is acceptable, click **Finish** to accept the new configuration. A Reconstruct operation begins on the virtual disk. You can monitor the progress of the reconstruction in the Group Show Progress window. To do so, select **Group Operations | Show Progress**.

Changing the RAID Level of a Virtual Disk

Warning: Be sure to back up the data on the virtual disk before you change its RAID level.

You can use Intel® RAID Web Console 2 to change the RAID level of an existing virtual disk. To do this, follow these steps:

1. Select a virtual disk icon in the left panel and then select **Operations | Advanced Operations | Configuration | Reconstruction Wizard**.
2. When the Reconstruction Wizard window is displayed, click **Change RAID Level**.
3. When the next screen is displayed, select the desired RAID level from the drop-down menu in the lower right corner.

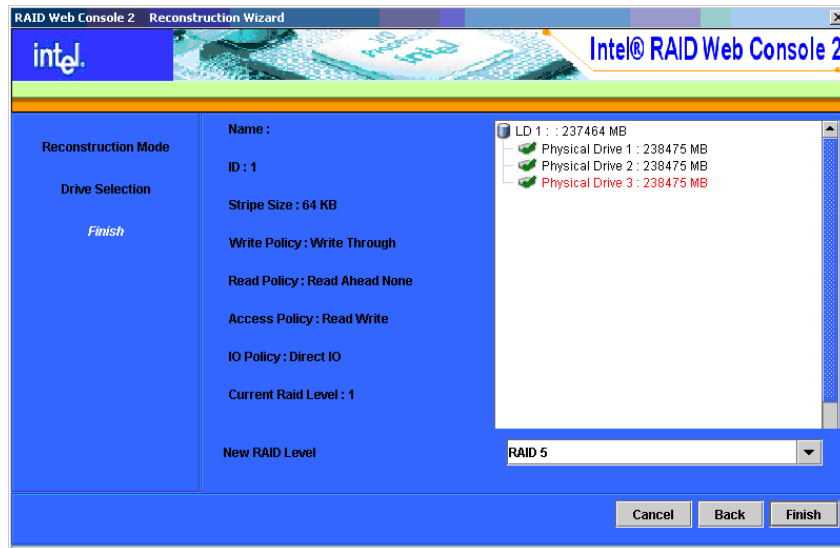

Figure 64. Selecting RAID Level

4. Click **Finish** to accept the new RAID level.
A Reconstruct operation begins on the virtual disk. You can monitor the progress of the reconstruction in the Group Show Progress window. To do so, select **Group Operations | Show Progress**.

Changing Virtual Disk Properties

You can change a virtual disk's Read Policy, Write Policy, and other properties after the disk is created. To do this, follow these steps:

1. Select a virtual disk icon in the left panel and then select **Operations | Set Virtual Disk Properties**. Alternatively, click the **Properties** panel and then click **Set Virtual Disk Properties**. Figure 65 shows the Set Virtual Disk Properties screen.



Figure 65. Set Virtual Disk Properties

2. Change the properties as needed in the right panel.
3. Click **Go** to accept the changes.

Deleting a Virtual Disk

Warning: Be sure to back up the data on the virtual disk before you delete it.

You can delete one or more virtual disk. Before you can do this, you must be logged on to the system in All Access mode. To delete a virtual disk, follow these steps:

1. Back up all user data on the virtual disk you intend to delete.
2. In the left panel, select the **Logical** tab and click the icon of the virtual disk you want to delete.
3. In the right panel, select the **Operations** tab and select **Delete Virtual Disk**. Click **Go**.
4. When the warning message is displayed, click **Yes** to confirm that you want to delete the virtual disk.

Managing Configurations

You can use Intel[®] RAID Web Console 2 to manage the configurations that you create. For example, you can save a storage configuration that you have already defined on a controller and load this configuration from disk to another controller, after first clearing the existing configuration from that controller. In order to do this, you must be logged on to the system in All Access mode. This section explains how to do these tasks.

Saving a Configuration to Disk

You can save an existing controller configuration to a file so you can apply it to another controller. To save a configuration file, follow these steps:

1. Select a controller icon in the left panel of the Intel[®] RAID Web Console 2 window.
2. Select **Operations | Advanced Operations | Configuration | Save Configuration** as shown below.

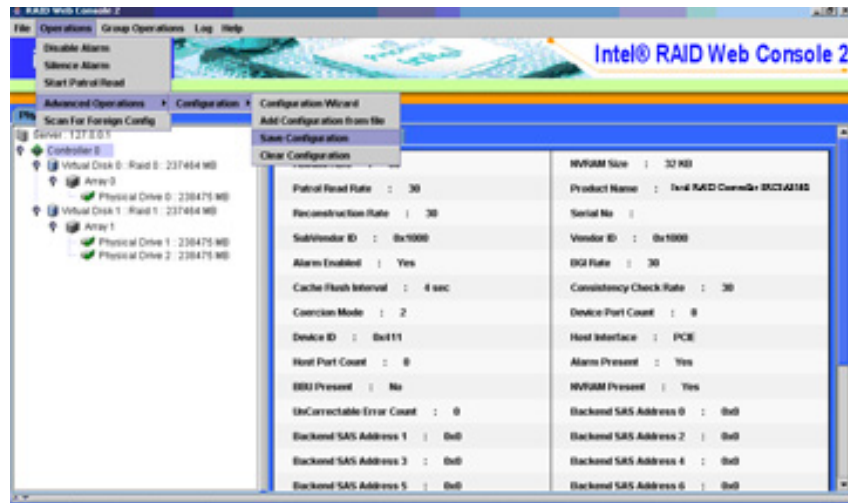

Figure 66. Save Configuration to File

The Save dialog box is displayed, as shown in [Figure 67](#).

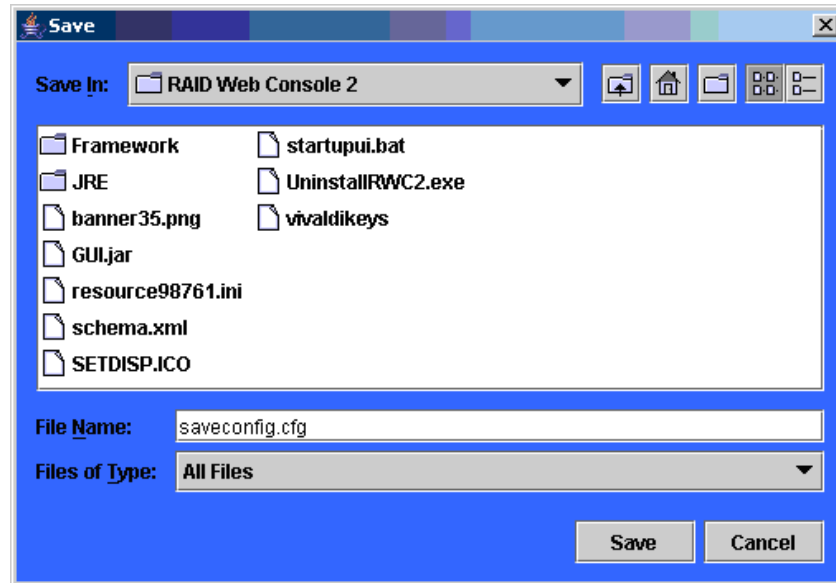

Figure 67. Save Configuration Dialog Box

3. In the dialog box, type a name for the configuration file.
4. Click **Save** to save the configuration file, or accept the default name (hostname.cfg).

Clearing a Configuration from a Controller

If you want to manually create a new storage configuration on a controller, or load a configuration file on a controller, you must first clear the existing configuration.

Warning: Before you clear a configuration, be sure to save any data that you want to keep! Clearing a configuration deletes all data from the disks in the existing configuration.

To clear a configuration from a controller, follow these steps:

1. Select a controller icon in the left panel of the Intel® RAID Web Console 2 window.
2. Select **Operations | Advanced Operations | Configuration | Clear Configuration**.

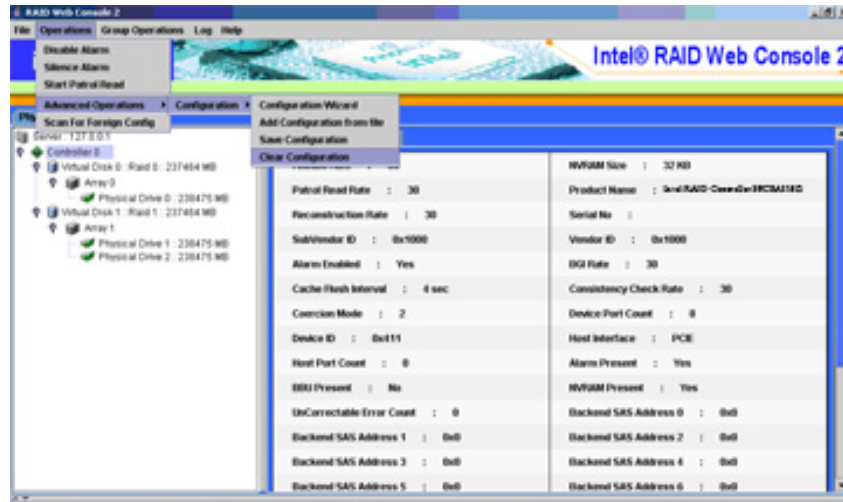

Figure 68. Clear Configuration

3. A Warning message is displayed. Click **Yes** to clear the configuration or **No** to cancel the operation.

Adding a Configuration from a File

When you replace a controller, or when you want to duplicate an existing storage configuration on a new controller, you can add a saved configuration to the controller.

Warning: When you add a saved configuration to a replacement controller, be sure that the number and size of the physical disks connected to the controller is exactly the same as it was when the configuration was saved.

To add a saved configuration, follow these steps:

1. Select a controller icon in the left panel of the Intel[®] RAID Web Console 2 window.
2. Select **Operations | Advanced Operations | Configuration | Add Configuration from File**.

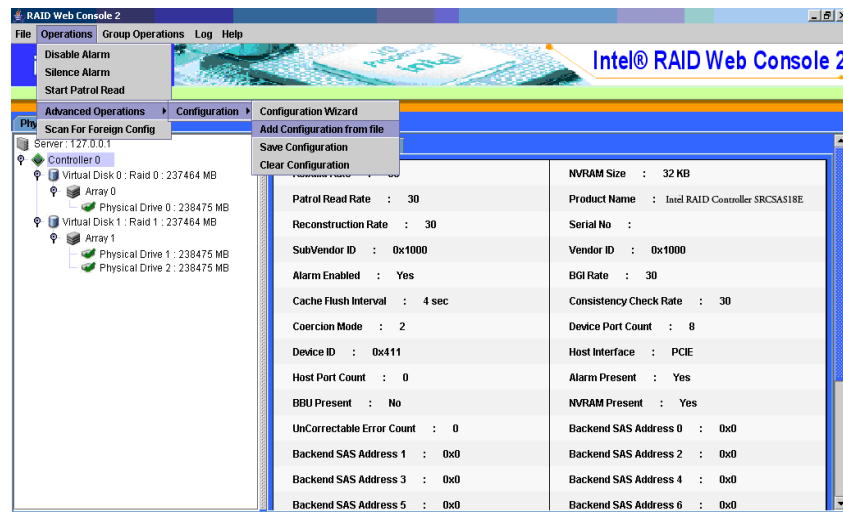

Figure 69. Add Saved Configuration

3. A Warning message is displayed. Click **Yes**. When the Open dialog box is displayed, select the configuration file and click **Open**.
4. View the configuration detail, then select **Apply**.
5. Confirm the new configuration when prompted.

When a system log is displayed, the Log menu has three options:

- **Save Log:** Saves the current log to a .log file.
- **Clear Log:** Clears the current log information, if you have full access (versus view-only access).
- **Load Log:** Enables you to load a local .log file.

When a local log is displayed, the status bar lists the name of the local log file, and the Log menu has an additional option, **Read Server Log**, that enables you to retrieve the system log. The **Clear Log** option is disabled when a local log is displayed.

Monitoring Controllers

When Intel® RAID Web Console 2 is running, you can see the status of all controllers in the left panel. If the controller is operating normally, the controller icon looks like this: . If the controller has failed, a small red circle is displayed to the right of the icon.

To display complete controller information, click on a controller icon in the left panel and click the **Properties** tab in the right panel. [Figure 71](#) shows the Controller Information window.

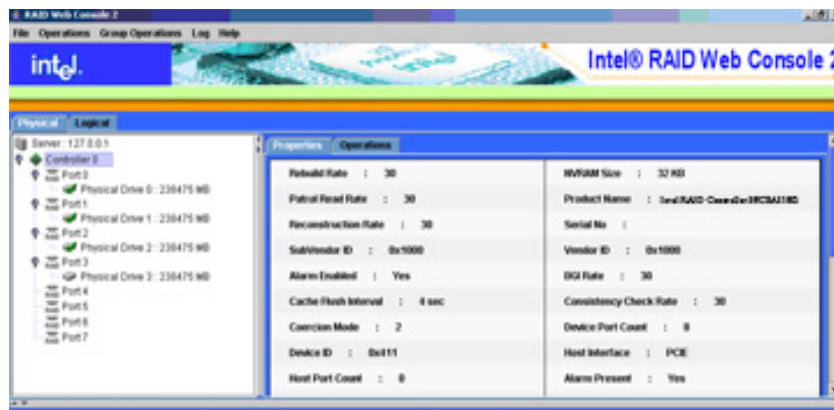



Figure 71. Controller Information

Note the following:

- The *Rebuild rate*, *Patrol read rate*, *Reconstruction rate*, *Consistency check rate*, and *BGI rate* (background initialization) are all user-selectable. For more information, see [“Setting Adjustable Task Rates,” on page 71](#).
- The *BBU Present* field indicates whether a battery backup unit is installed.
- The *Alarm Present* and *Alarm Enabled* fields indicate whether the controller has an alarm to alert the user with an audible tone when there is an error or problem on the controller. There are options on the controller Properties tab for silencing or disabling the alarm. For more information, see [“Setting Adjustable Task Rates,” on page 71](#).

Monitoring Disk Drives and Other Physical Devices

When the Intel® RAID Web Console 2 is running, you can see the status of all physical disk drives and other physical devices in the left panel. If the physical drive is operating normally, the controller icon looks like this: . If the physical drive has failed, a small red circle is displayed to the right of the icon.

To display complete physical drive Information, click on a physical drive icon in the left panel and click the **Properties** tab in the right panel. Figure 72 shows the Properties panel for a physical drive.



Figure 72. Physical Drive Information

There are no user-selectable properties for physical devices. Icons for other physical devices such as CD-ROM drives and DAT drives may also appear in the left panel.

If the physical drives are in a disk enclosure, you can identify which physical drive is represented by a disk icon on the left. To do this, follow these steps:

1. Click the physical disk icon in the left panel.
2. Click the **Operations** tab in the right panel.
3. Select **Locate Physical Drive** and click **Go**.



Figure 73. Locating Physical Drive

The LED on the physical disk drive in the enclosure starts blinking to show its location.

Note: LEDs on drives that are global or dedicated hotspares do not blink.

4. To stop the disk drive light from blinking, select **Stop Locating Physical Drive** and click **Go**.

Running a Patrol Read

A Patrol Read periodically verifies all sectors of physical disks that are connected to a controller, including the system reserved area in the RAID configured drives. Patrol Read works for all RAID levels and for all hotspare drives. A patrol read is initiated only when the controller is idle for a defined period and has no other background activities.

To enable and configure Patrol Read, follow these steps:



1. Click a controller icon in the left panel.
2. Select the **Operations** tab in the right panel, and select **Set Patrol Read Properties**, as shown in [Figure 74](#).



Figure 74. Patrol Read Configuration

3. Select an Operation Mode for patrol read. The options are:
 - **Auto**: Patrol Read runs automatically at the time interval you specify on this screen.
 - **Manual**: Patrol Read runs only when you manually start it by selecting **Start Patrol Read** from the controller options screen (see [Figure 74](#)).
 - **Disabled**: Patrol Read does not run at all.
4. (optional) Specify a maximum count of physical drives to include in the patrol read. The default number is 255; you can specify a lower number if you wish.
5. (optional) Select virtual disks on this controller to exclude from the Patrol Read. The existing virtual disks are listed in the gray box. To exclude a virtual disk, check the box next to it.
6. Enter the frequency at which the Patrol Read will run, in seconds.
7. Click **Go** to enable these Patrol Read options.

Monitoring Virtual Disks

When the Intel® RAID Web Console 2 is running, you can see the status of all virtual disks. If a virtual disk is operating normally, the icon looks like this: . If the virtual disk is running in degraded mode—for example, if a physical disk has failed—a small yellow circle is displayed to the right of the icon looks like this: .

When the Logical tab is selected, the panel on the left shows which physical disks are used by each virtual disk. In [Figure 75](#) you can see that the virtual disk uses physical disks 1, 2, and 3. The same physical disk can be used by multiple virtual disks.

To display complete virtual disk information, click the **Logical** tab in the left panel, click on a virtual disk icon in the left panel, and click the **Properties** tab in the right panel. [Figure 75](#) shows the Properties tab for a virtual disk.



Figure 75. Virtual Disk Properties

The RAID level, stripe size, and access policy of the virtual disk are set when it is configured.

Note: You can change the Read Policy, Write Policy, and other virtual disk properties by selecting **Operations | Set Virtual Disk Properties**.

Monitoring Enclosures

When the Intel® RAID Web Console 2 is running, you can see the status of all enclosures that are operating normally. Information about the enclosure is displayed in the right panel when you select the **Properties** tab. Figure 76 shows the more complete enclosure information that is displayed when you select the **Graphical View** tab.

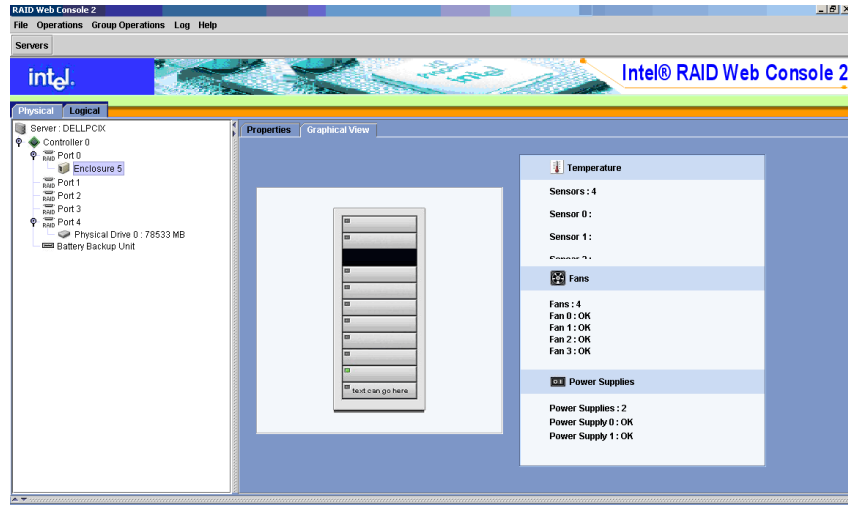

Figure 76. Enclosure Information - Graphical View

The display in the center of the screen shows how many slots of the enclosure are populated by disk drives, and the lights on the disk drives show the drive status. The information on the right shows you the status of the temperature sensors, fans, and power supplies in the enclosure.

Monitoring Battery Backup Units

When the Intel® RAID Web Console 2 is running, you can see the status of all battery backup units. The battery backup unit information is displayed in the right panel when you select the Properties tab. This information includes the number of times the battery has been recharged (cycle count), the remaining battery capacity and estimated run time to empty, the current battery temperature, and so on.

Figure 77 shows the BBU information that is displayed in the right panel when you select the Properties tab.

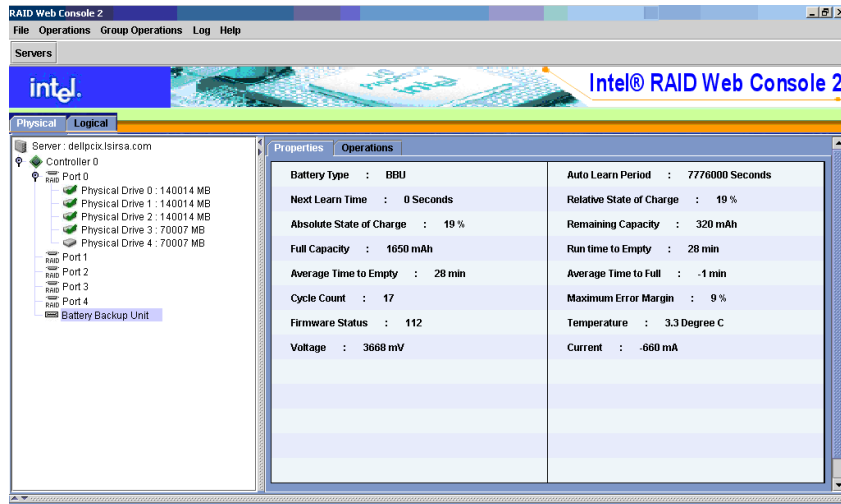

Figure 77. Battery Backup Unit Information

Monitoring Rebuilds and Other Processes

The Intel® RAID Web Console 2 allows you to monitor the progress of rebuilds and other lengthy processes in the Group Show Progress window, shown in Figure 78. You open this window by selecting **Group Operations | Show Progress**.

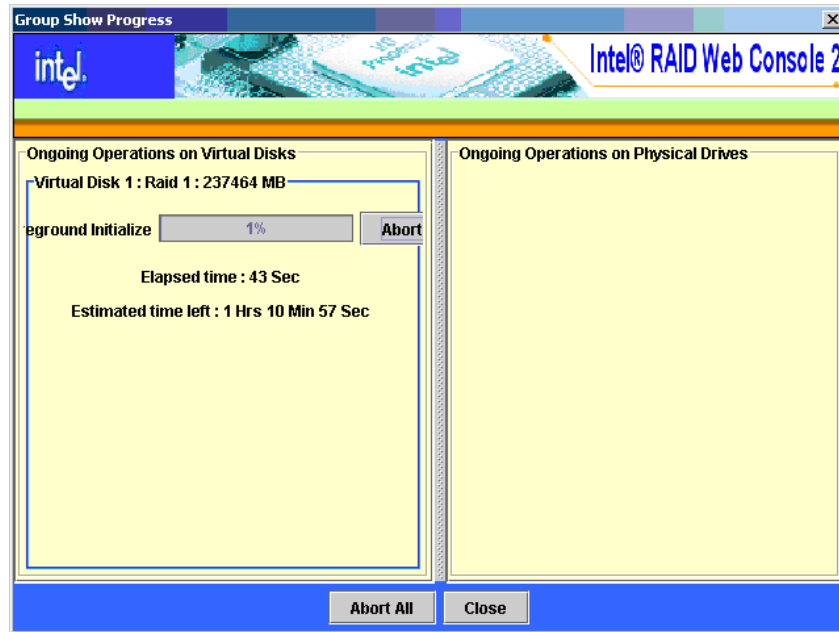

Figure 78. Group Show Progress Window

Operations on virtual disks appear in the left panel of the window, and operations on physical drives appear in the right panel. The types of operations that appear in this window are as follows:

- Initialization of a virtual disk (see “[Initializing a Virtual Disk](#),” on page 92).
- Rebuild (see “[Rebuilding a Drive](#),” on page 94).
- Reconstruction (see “[Adding a Drive to a Virtual Disk](#),” on page 72).
- Consistency check (see “[Running a Consistency Check](#),” on page 93).

Note: A Reconstruction process cannot be aborted. To abort any other ongoing process, click **Abort** next to the status indicator. Click **Abort All** to abort all ongoing processes. Click **Close** to close the window.

Maintaining and Managing Storage Configurations

This section explains how to use Intel® RAID Web Console 2 to maintain and manage storage configurations. You must log on to the system in Full Access mode to do these maintenance and management tasks. The following maintenance and management functions can be done:

- [Initializing a Virtual Disk](#)
- [Running a Consistency Check](#)
- [Rebuilding a Drive](#)
- [Removing a Drive](#)
- [Flashing the Firmware](#)

Initializing a Virtual Disk

When you create a new virtual disk with the Configuration Wizard, you can choose to initialize the disk immediately. To initialize a virtual disk after the configuration process, follow these steps:

1. Select the **Logical** tab in the left panel, and click the icon of the virtual disk to initialize.
2. Select **Group Operations | Initialize**.



Figure 79. Selecting Initialize

3. The Group Initialize dialog box is displayed. Select the virtual disk(s) to initialize. Select **Fast Initialization** if you want to use this option.

Fast Initialization quickly formats the virtual disk by writing zeros to the first few sectors of the physical disks in the virtual disk. Regular initialization takes longer, depending on the number and size of the physical disks in the virtual disk.

4. Click **Start** to begin the initialization.

You can monitor the progress of the initialization, if you want to. See [“Monitoring Rebuilds and Other Processes,”](#) on page 91 for more information.

Running a Consistency Check

You should periodically run a consistency check on fault-tolerant virtual disks. A consistency check scans the virtual disk to determine whether consistency data has become corrupted and needs to be restored. It is especially important to do this if you suspect that the virtual disk consistency data may be corrupted.

To run a consistency check, follow these steps:

1. Select **Group Operations | Check Consistency**. The Group Consistency Check window is displayed, as shown in [Figure 80](#).

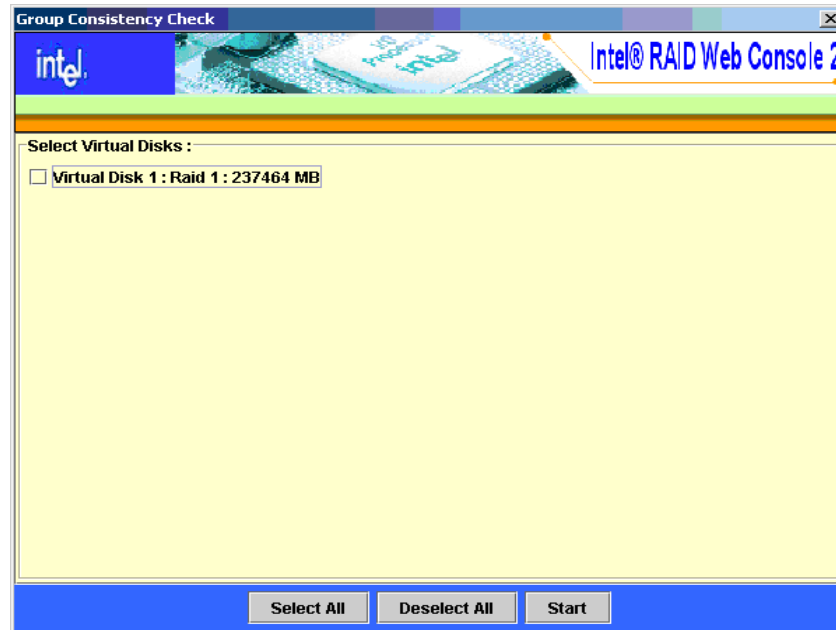

Figure 80. Group Consistency Check Window

2. Select the virtual disks that you want to check, or click **Select All** to select all disks.
3. Click **Start** to begin. You can monitor the progress of the consistency check. See [“Monitoring Rebuilds and Other Processes,”](#) on page 91 for more information.

Note: You can also run a consistency check by selecting the virtual disk icon in the left panel and selecting the option on the Operation tab in the right panel. You can select the “Automatically fix errors” check box if you want to.

Scanning for New Drives

The Intel® RAID Web Console 2 normally detects newly installed disk drives and other storage devices and displays icons for them on the main screen. If the Intel® RAID Web Console 2 does not detect a new drive, you can use the **Scan for Foreign Configuration** option to find it. To do this, follow these steps:

1. Select a controller icon in the left panel.
2. Select **Operations | Scan for Foreign Configuration**.





Figure 81. Scan for Foreign Configuration

If the Intel® RAID Web Console 2 detects any new disk drives, it displays a list of them on the screen.

Rebuilding a Drive

If a single drive in a fault tolerant system fails, the system is protected from data loss by the parity data (in RAID 5 and RAID 50) or by data redundancy (RAID 1, RAID 10). The failed drive must be replaced, and the drive's data must be rebuilt on a new drive to restore the system to fault tolerance. (Or the data can be rebuilt on the failed drive, if the drive is still operational.) If dedicated or global hot spare disks are available, the failed drive is rebuilt automatically without any user intervention.

If a drive has failed, a red circle is displayed to the right of the disk drive icon: . A small yellow circle is displayed to the right of the icon of the virtual disk that uses this physical disk: . This indicates that the virtual disk is in a degraded state, but the data is still intact.

Follow these steps if you need to rebuild a physical drive:

1. Right click the icon of the failed drive and select **Rebuild**.
2. Click **Yes** when the warning message is displayed. If the drive is still good, a rebuild starts.

You can monitor the progress of the rebuild in the Group Show Progress window by selecting **Group Operations | Show Progress**. If the drive cannot be rebuilt, an error message is displayed, and you must replace the drive before a rebuild can occur. Continue with the next step.

3. Click the icon of the failed drive in the left panel and select the **Operations** tab in the right panel.
4. Select **Prepare for Removal**.
5. Click **Go**.



Figure 82. Preparing Drive for Removal

6. Physically remove the failed drive and replace it with a new drive of equal or greater capacity.

When the new drive spins up, the drive icon changes to green, and the rebuild begins automatically. You can monitor the progress of the rebuild in the Group Show Progress window by selecting **Group Operations | Show Progress**.

Note: If you want to force a disk drive into Fail status in order to trigger a rebuild, right-click the drive icon, and select **Make Drive Offline**.

Removing a Drive

You may sometimes need to remove a non-failed drive that is connected to the controller. For example, you may need to replace the drive with a larger drive. Follow these steps to remove a drive safely:

1. Click the icon of the drive in the left panel and select the **Operations** tab in the right panel.
2. Select **Prepare for Removal** and click **Go**.
3. If you change your mind, select **Undo Prepare for Removal** and click **Go**. Otherwise, wait until the drive spins down and then remove it.

Warning: Never replace a drive that has not failed (and is not marked by the controller as failed) while the system is powered off. A drive must always be failed before it is replaced in an array.

Flashing the Firmware

The Intel® RAID Web Console 2 enables you to easily upgrade the controller firmware. To flash the controller firmware follow these steps:

1. In the left panel, click on the icon of the controller you need to upgrade.
2. In the right panel, click the **Operations** tab and select **Flash Firmware**.
3. Click **Go**.



Figure 83. Flashing the Firmware

4. Browse for the .rom flash update file and click **OK**. The Intel® RAID Web Console 2 displays the version of the existing firmware and the version of the new firmware file.
5. When you are prompted to ask if you want to upgrade the firmware, click **Yes**. The controller is updated with the new firmware code contained in the .ROM file.

Appendix A: Configuring RAID 0, 1, or 5 using Custom Configuration

1. Start the Intel[®] RAID Web Console 2 by selecting **Start | Programs | RAID Web Console 2**.
2. Double click the icon on the system that you want to access. The Server Login Window is displayed as shown.
3. Select an full access mode from the drop-down menu.
4. Enter your user name and password and click **Login**.
5. Select a controller and select **Operations | Advanced Operations | Configuration | Configuration Wizard**.

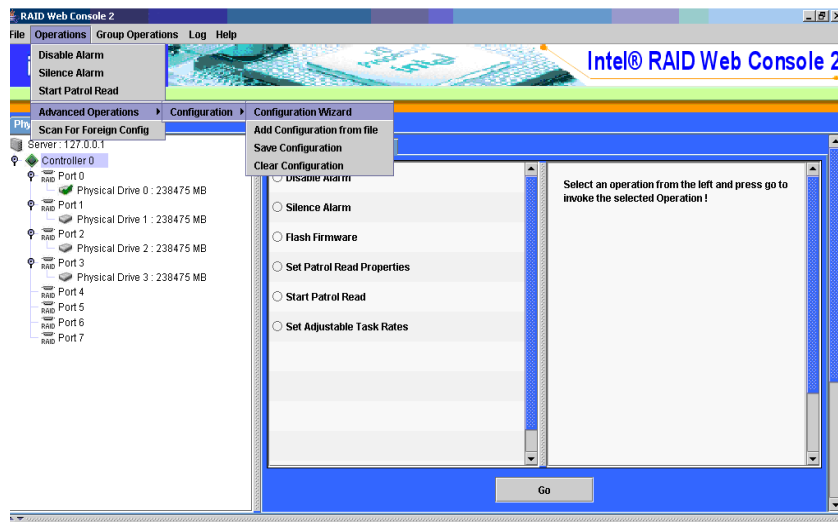

Figure 84. Starting Configuration Wizard

1. Select **Manual Configuration**.

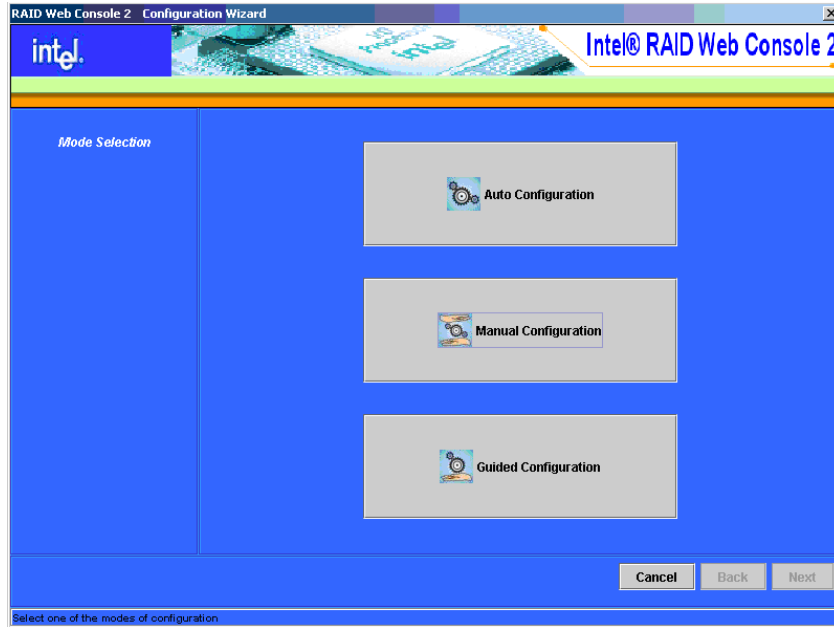

Figure 85. Selecting Manual Configuration

6. Select the drives:

- RAID 0 or RAID 1: Select two drives by highlighting each drive individually and then clicking the right arrow button.
- RAID 5: Select three drives by highlighting each drive individually and then clicking the right arrow button.

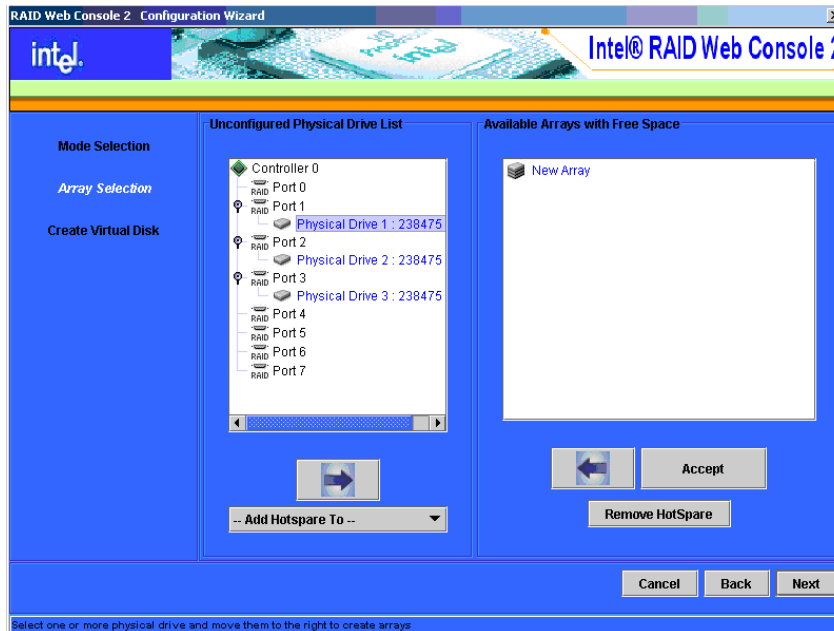

Figure 86. Selecting Drives for RAID 0

The selected drives are added to the right pane, as shown below.

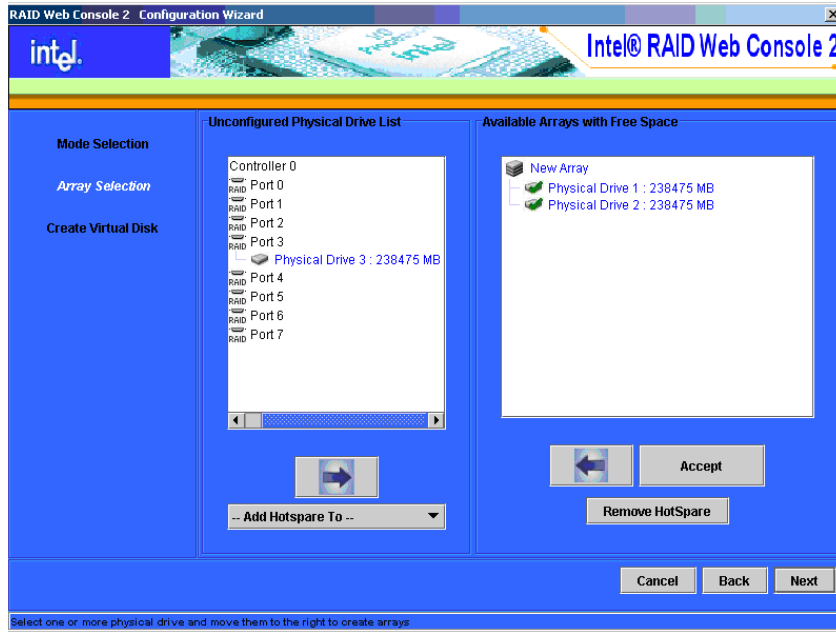

Figure 87. Drives Selected for RAID 0

7. Click **Accept** to accept the array or disk group.
8. Click **Next** to define the virtual disk created from the array or disk group. The scrolling menu in the upper middle panel shows the arrays or disk groups that have available space.
9. Select the newly created array "New Array 0" as shown by the example below.

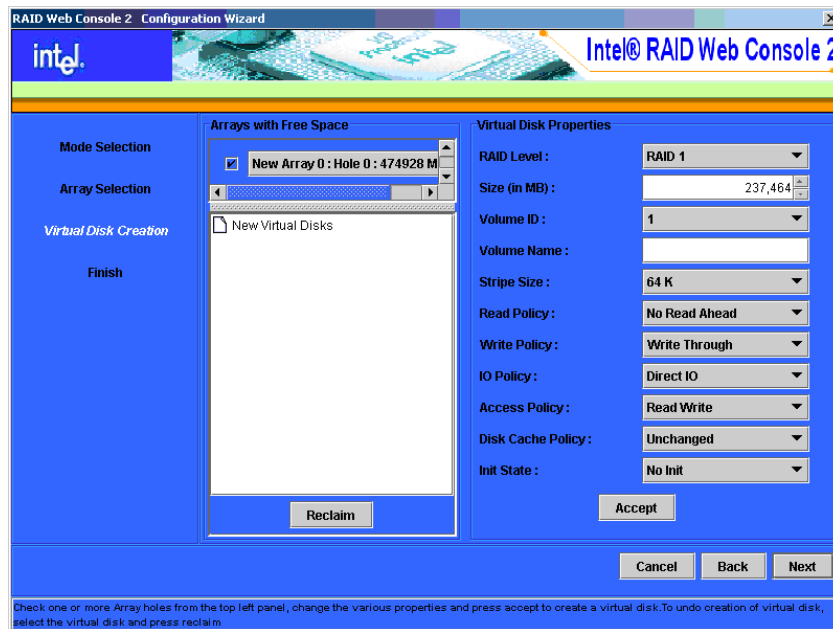

Figure 88. Configure RAID 0 Parameters

10. Select the array type (RAID 0, RAID 1, or RAID 5) and set the rest of the RAID parameters, Stripe Size, Read Policy, Write Policy, and other parameters according to the needs of your application. For more information on these parameters see “Manual Configuration,” on page 58.
11. Click **Accept** to set the parameters and define the new array or disk group.

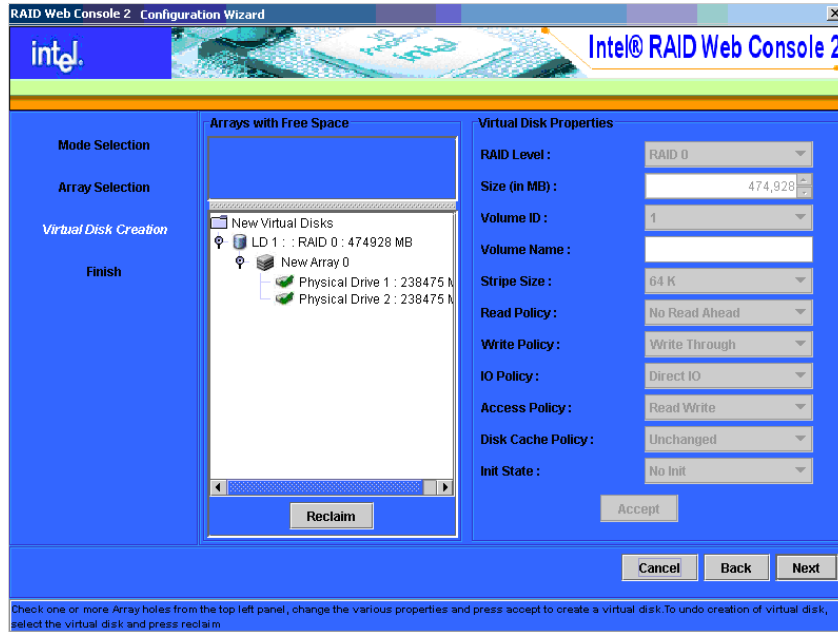

Figure 89. Accepting RAID 0 Parameters

12. Click **Finish** to define the new array or disk group.

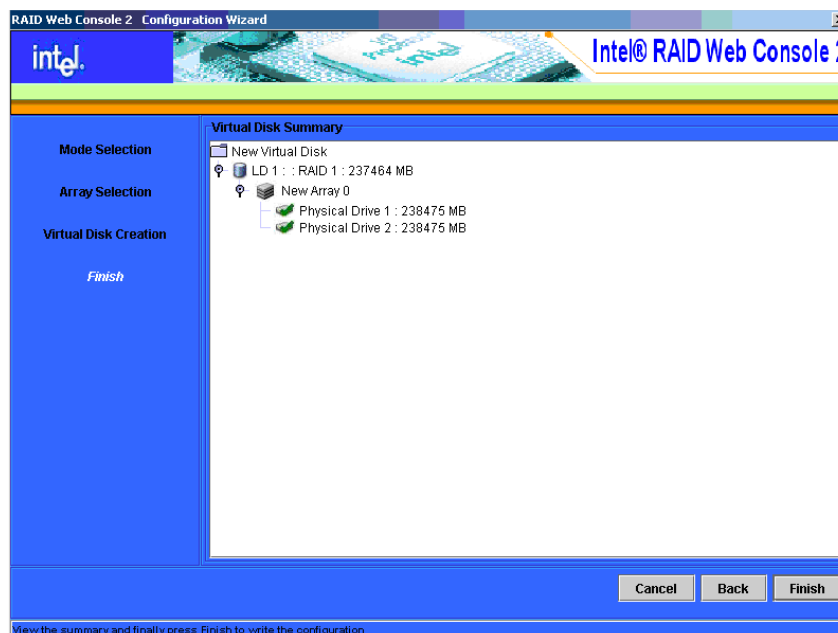

Figure 90. Completing RAID 0 Configuration

The new array or disk group is visible when you select the **Logical** tab.



Figure 91. RAID 0 in Logical Tab

Appendix B: Events and Messages

This appendix lists the Intel® RAID Web Console 2 events that may appear in the event log.

The Intel® RAID Web Console 2 monitors the activity and performance of all controllers in the server and the devices attached to them. When an “event” occurs—such as the completion of a consistency check or the removal of a physical drive—an event message is displayed in the log displayed at the bottom of the Intel® RAID Web Console 2 screen. The messages are also logged in the Windows Application log (Event Viewer). Error event levels are:

- **Progress:** This is a progress posting event. Progress events are not saved in NVRAM.
- **Info:** Informational message. No user action is necessary.
- **Warning:** Some component may be close to a failure point
- **Critical:** A component has failed, but the system has not lost data
- **Fatal:** A component has failed, and data loss has occurred or will occur
- **Dead:** A catastrophic error has occurred and the controller has died. This is seen only after the controller has been restarted.

The following table lists all of the Intel® RAID Web Console 2 event messages:

Table 2. MFI Event Messages

Number	Type	Description
0	Info	Firmware initialization started (PCI ID %04x/%04x/%04x/%04x)
1	Info	Firmware version %s
2	Fatal	Unable to recover cache data from TBBU
3	Info	Cache data recovered from TBBU successfully
4	Info	Configuration cleared
5	Warning	Cluster down; communication with peer lost
6	Info	Logical drive %s ownership changed from %02x to %02x
7	Info	Alarm disabled by user
8	Info	Alarm enabled by user
9	Info	Background initialization rate changed to %d%%
10	Fatal	Controller cache discarded due to memory/battery problems
11	Fatal	Unable to recover cache data due to configuration mismatch
12	Info	Cache data recovered successfully
13	Fatal	Controller cache discarded due to firmware version incompatibility
14	Info	Consistency Check rate changed to %d%%
15	Dead	Fatal firmware error: %s
16	Info	Factory defaults restored
17	Info	Flash downloaded image corrupt
18	Caution	Flash erase error
19	Caution	Flash timeout during erase
20	Caution	Flash error
21	Info	Flashing image: %s
22	Info	Flash of new firmware image(s) complete
23	Caution	Flash programming error
24	Caution	Flash timeout during programming
25	Caution	Flash chip type unknown
26	Caution	Flash command set unknown
27	Caution	Flash verify failure
28	Info	Flush rate changed to %d seconds
29	Info	Hibernate command received from host
30	Info	Event log cleared
31	Info	Event log wrapped
32	Dead	Multi-bit ECC error: ECAR=%x
33	Warning	Single-bit ECC error: ECAR=%x
34	Dead	Not enough controller memory
35	Info	Patrol Read complete
36	Info	Patrol Read paused
37	Info	Patrol Read Rate changed to %d%%
38	Info	Patrol Read resumed
39	Info	Patrol Read started

Table 2. MFI Event Messages (Cont.)

Number	Type	Description
40	Info	Rebuild rate changed to %d%%
41	Info	Reconstruction rate changed to %d%%
42	Info	Shutdown command received from host
43	Info	Test event: '%s'
44	Info	Time established as %s; (%d seconds since power on)
45	Info	User entered firmware debugger
46	Warning	Background Initialization aborted on %s
47	Warning	Background Initialization corrected medium error (%s at %lx
48	Info	Background Initialization completed on %s
49	Fatal	Background Initialization completed with uncorrectable errors on %s
50	Fatal	Background Initialization detected uncorrectable double medium errors (%s at %lx on %s)
51	Caution	Background Initialization failed on %s
52	Progress	Background Initialization progress on %s is %s
53	Info	Background Initialization started on %s
54	Info	Policy change due to BBU on %s from %s to %s
55	Info	Policy change due to user on %s from %s to %s
56	Warning	Consistency Check aborted on %s
57	Warning	Consistency Check corrected medium error (%s at %lx
58	Info	Consistency Check done on %s
59	Info	Consistency Check done with corrections on %s
60	Fatal	Consistency Check detected uncorrectable double medium errors (%s at %lx on %s)
61	Caution	Consistency Check failed on %s
62	Fatal	Consistency Check failed with uncorrectable data on %s
63	Warning	Consistency Check found inconsistent parity on %s at strip %lx
64	Warning	Consistency Check inconsistency logging disabled on %s (too many inconsistencies)
65	Progress	Consistency Check progress on %s is %s
66	Info	Consistency Check started on %s
67	Warning	Initialization aborted on %s
68	Caution	Initialization failed on %s
69	Progress	Initialization progress on %s is %s
70	Info	Fast initialization started on %s
71	Info	Full initialization started on %s
72	Info	Initialization complete on %s
73	Info	LD Properties updated to %s (form %s)
74	Info	Reconstruction complete on %s
75	Fatal	Reconstruction of %s stopped due to unrecoverable errors
76	Fatal	Reconstruct detected uncorrectable double medium errors (%s at %lx on %s at %lx)
77	Progress	Reconstruction progress on %s is %s
78	Info	Reconstruction resumed on %s

Table 2. MFI Event Messages (Cont.)

Number	Type	Description
79	Fatal	Reconstruction resume of %s failed due to configuration mismatch
80	Info	Reconstructing started on %s
81	Info	State change on %s from %s to %s
82	Info	PD Clear aborted on %s
83	Caution	PD Clear failed on %s (Error %02x)
84	Progress	PD Clear progress on %s is %s
85	Info	PD Clear started on %s
86	Info	PD Clear completed on %s
87	Warning	Error on %s (Error %02x)
88	Info	Format complete on %s
89	Info	Format started on %s
90	Caution	Hot Spare SMART polling failed on %s (Error %02x)
91	Info	PD inserted: %s
92	Warning	PD %s is not supported
93	Warning	Patrol Read corrected medium error on %s at %lx
94	Progress	Patrol Read progress on %s is %s
95	Fatal	Patrol Read found an uncorrectable medium error on %s at %lx
96	Caution	Predictive failure: CDB: %s
97	Fatal	Patrol Read puncturing bad block on %s at %lx
98	Info	Rebuild aborted by user on %s
99	Info	Rebuild complete on %s
100	Info	Rebuild complete on %s
101	Caution	Rebuild failed on %s due to source drive error
102	Caution	Rebuild failed on %s due to target drive error
103	Progress	Rebuild progress on %s is %s
104	Info	Rebuild resumed on %s
105	Info	Rebuild started on %s
106	Info	Rebuild automatically started on %s
107	Caution	Rebuild stopped on %s due to loss of cluster ownership
108	Fatal	Reassign write operation failed on %s at %lx
109	Fatal	Unrecoverable medium error during rebuild on %s at %lx
110	Info	Corrected medium error during recovery on %s at %lx
111	Fatal	Unrecoverable medium error during recovery on %s at %lx
112	Info	PD removed: %s
113	Warning	CDB: %s
114	Info	State change on %s from %s to %s
115	Info	State change by user on %s from %s to %s
116	Warning	Redundant path to %s broken
117	Info	Redundant path to %s restored
118	Info	Dedicated Hot Spare PD %s no longer useful due to deleted array
119	Caution	SAS topology error: Loop detected

Table 2. MFI Event Messages (Cont.)

Number	Type	Description
120	Caution	SAS topology error: Unaddressable device
121	Caution	SAS topology error: Multiple ports to the same SAS address
122	Caution	SAS topology error: Expander error
123	Caution	SAS topology error: SMP timeout
124	Caution	SAS topology error: Out of route entries
125	Caution	SAS topology error: Index not found
126	Caution	SAS topology error: SMP function failed
127	Caution	SAS topology error: SMP CRC error
128	Caution	SAS topology error: Multiple subtractive
129	Caution	SAS topology error: Table to table
130	Caution	SAS topology error: Multiple paths
131	Fatal	Unable to access device %s
132	Info	Dedicated Hot Spare created on %s (%s)
133	Info	Dedicated Hot Spare %s disabled
134	Caution	Dedicated Hot Spare %s no longer useful for all arrays
135	Info	Global Hot Spare created on %s (%s)
136	Info	Global Hot Spare %s disabled
137	Caution	Global Hot Spare does not cover all arrays
138	Info	Created %s}
139	Info	Deleted %s}
140	Info	Marking LD %s inconsistent due to active writes at shutdown
141	Info	Battery Present
142	Warning	Battery Not Present
143	Info	New Battery Detected
144	Info	Battery has been replaced
145	Caution	Battery temperature is high
146	Warning	Battery voltage low
147	Info	Battery is charging
148	Info	Battery is discharging
149	Info	Battery voltage is normal
150	Fatal	Battery needs to be replacement
151	Info	Battery relearn started
152	Info	Battery relearn in progress
153	Info	Battery relearn completed
154	Caution	Battery relearn timed out
155	Info	Battery relearn pending: Battery is under charge
156	Info	Battery relearn postponed
157	Info	Battery relearn will start in 4 days
158	Info	Battery relearn will start in 2 day
159	Info	Battery relearn will start in 1 day
160	Info	Battery relearn will start in 5 hours

Table 2. MFI Event Messages (Cont.)

Number	Type	Description
161	Info	Battery removed
162	Info	Current capacity of the battery is below threshold
163	Info	Current capacity of the battery is above threshold
164	Info	Enclosure (SES) discovered on %s
165	Info	Enclosure (SAF-TE) discovered on %s
166	Caution	Enclosure %s communication lost
167	Info	Enclosure %s communication restored
168	Caution	Enclosure %s fan %d failed
169	Info	Enclosure %s fan %d inserted
170	Caution	Enclosure %s fan %d removed
171	Caution	Enclosure %s power supply %d failed
172	Info	Enclosure %s power supply %d inserted
173	Caution	Enclosure %s power supply %d removed
174	Caution	Enclosure %s SIM %d failed
175	Info	Enclosure %s SIM %d inserted
176	Caution	Enclosure %s SIM %d removed
177	Warning	Enclosure %s temperature sensor %d below warning threshold
178	Caution	Enclosure %s temperature sensor %d below error threshold
179	Warning	Enclosure %s temperature sensor %d above warning threshold
180	Caution	Enclosure %s temperature sensor %d above error threshold
181	Caution	Enclosure %s shutdown
182	Warning	Enclosure %s not supported; too many enclosures connected to port
183	Caution	Enclosure %s firmware mismatch
184	Warning	Enclosure %s sensor %d bad
185	Caution	Enclosure %s phy %d bad
186	Caution	Enclosure %s is unstable
187	Caution	Enclosure %s hardware error
188	Caution	Enclosure %s not responding
189	Info	SAS/SATA mixing not supported in enclosure; PD %s disabled
190	Info	Enclosure (SES) hotplug on %s was detected, but is not supported
191	Info	Clustering enabled
192	Info	Clustering disabled
193	Info	PD too small to be used for auto-rebuild on %s
194	Info	BBU enabled; changing WT virtual disks to WB
195	Warning	BBU disabled; changing WB virtual disks to WT
196	Warning	Bad block table on PD %s is 80% full
197	Fatal	Bad block table on PD %s is full; unable to log block %lx
198	Info	Consistency Check Aborted Due to Ownership Loss on %s
199	Info	Background Initialization (BGI) Aborted Due to Ownership Loss on %s
200	Caution	Battery/charger problems detected; SOH Bad
201	Warning	Single-bit ECC error: ECAR=%x, ELOG=%x, (%s); warning threshold exceeded

Table 2. MFI Event Messages (Cont.)

Number	Type	Description
202	Caution	Single-bit ECC error: ECAR=%x, ELOG=%x, (%s); critical threshold exceeded
203	Caution	Single-bit ECC error: ECAR=%x, ELOG=%x, (%s); further reporting disabled
204	Caution	Enclosure %s Power supply %d switched off
205	Info	Enclosure %s Power supply %d switched on
206	Caution	Enclosure %s Power supply %d cable removed
207	Info	Enclosure %s Power supply %d cable inserted
208	Info	Enclosure %s Fan %d returned to normal
209	Info	BBU Retention test was initiated on previous boot
210	Info	BBU Retention test passed
211	Caution	BBU Retention test failed!
212	Info	NVRAM Retention test was initiated on previous boot
213	Info	NVRAM Retention test passed
214	Caution	NVRAM Retention test failed!
215	Info	%s test completed %d passes successfully
216	Caution	%s test FAILED on %d pass. Fail data: errorOffset=%x goodData=%x badData=%x
217	Info	Self check diagnostics completed
218	Info	Foreign Configuration Detected
219	Info	Foreign Configuration Imported
220	Info	Foreign Configuration Cleared

